

**Technical Protocol for Implementing Intrinsic
Remediation with Long-Term Monitoring for
Natural Attenuation of Fuel Contamination
Dissolved in Groundwater**

Volume II

By

Todd Wiedemeier

Parsons Engineering Science, Inc.
Denver, Colorado

John T. Wilson and Donald H. Kampbell

U.S. Environmental Protection Agency
Robert S. Kerr Laboratory
Ada, Oklahoma

Ross N. Miller and Jerry E. Hansen

Air Force Center for Environmental Excellence
Technology Transfer Division
Brooks AFB, San Antonio, Texas

DISTRIBUTION STATEMENT A

Approved for public release;
Distribution Unlimited

19970425 018

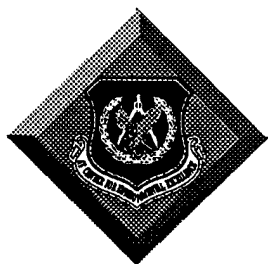

**Air Force Center for Environmental Excellence
Technology Transfer Division
Brooks AFB, San Antonio, Texas**

TECHNICAL PROTOCOL FOR IMPLEMENTING INTRINSIC
REMEDATION WITH LONG-TERM MONITORING FOR
NATURAL ATTENUATION OF FUEL CONTAMINATION
DISSOLVED IN GROUNDWATER

VOLUME II

by

Todd H. Wiedemeier
Parsons Engineering Science, Inc.
Denver, Colorado

Dr. John T. Wilson and Dr. Donald H. Kampbell
United States Environmental Protection Agency*
National Risk Management Research Laboratory
Subsurface Protection and Remediation Division
Ada, Oklahoma

Lt. Col. Ross N. Miller and Jerry E. Hansen
Air Force Center for Environmental Excellence
Technology Transfer Division
Brooks Air Force Base, Texas

for

Air Force Center for Environmental Excellence
Technology Transfer Division
Brooks Air Force Base
San Antonio, Texas

*This United States Air Force guidance was developed in cooperation with United States Environmental Protection Agency (USEPA) researchers but was not issued by the USEPA and does not represent USEPA guidance.

This report is a work prepared for the United States Government by Parsons Engineering Science, Inc. and representatives from the United States Environmental Protection Agency. In no event shall either the United States Government or Parsons Engineering Science, Inc. have any responsibility or liability for any consequences of any use, misuse, inability to use, or reliance upon the information contained herein, nor does either warrant or otherwise represent in any way the accuracy, adequacy, efficacy, or applicability of the contents hereof.

DOCUMENT ORGANIZATION

VOLUME I

Section 1: Introduction

Section 2: Protocol For Implementing Intrinsic Remediation

Section 3: References

Appendix A: Site Characterization in Support of Intrinsic Remediation

Appendix B: Important Processes Affecting the Fate and Transport of Fuel Hydrocarbons in the Subsurface

Appendix C: Data Interpretation and Calculations

Appendix D: Modeling the Fate and Transport of Fuel Hydrocarbons Dissolved in Groundwater

VOLUME II

Appendix E: Intrinsic Remediation Demonstration at Hill Air Force Base, Utah

Appendix F: Intrinsic Remediation Demonstration at Patrick Air Force Base, Florida

VOLUME II
TABLE OF CONTENTS

- Appendix E: Intrinsic Remediation Demonstration at Hill Air Force Base, Utah
Appendix F: Intrinsic Remediation Demonstration at Patrick Air Force Base, Florida

ACKNOWLEDGMENTS

The authors would like to thank Mr. Doug Downey, Dr. Robert Edwards, Dr. Robert Taylor, Dr. Guy Sewell, Dr. Mary Randolph, Mr. Randall Ross, Dr. Hanadi Rifai, and Ms. E. Kinzie Gordon for their extensive and helpful reviews of this manuscript. Dr. Robert Edwards for his contributions to the analytical protocol presented in Table 2.1. Mr. Matt Swanson for his contribution to the sections on modeling. Kyle Cannon, R. Todd Herrington, Jeff Black, Dave Moutoux, Bill Crawford, Peter Guest, Leigh Benson, Mark Vesseley, Jeff Fetkenhour, John Hicks, Steve Ratzlaff, Michael Phelps, Don Malone, Tom Richardson, Saskia Hoffer, and Haiyan Liu for their efforts at making this project a success!

APPENDIX E

INTRINSIC REMEDIATION DEMONSTRATION AT HILL AFB, UTAH

INTRINSIC REMEDIATION
ENGINEERING EVALUATION/COST ANALYSIS

for

UST SITE 870
HILL AIR FORCE BASE
OGDEN, UTAH

June 1995

Prepared for:

AIR FORCE CENTER FOR ENVIRONMENTAL EXCELLENCE
BROOKS AIR FORCE BASE
SAN ANTONIO, TEXAS

AND

HILL AIR FORCE BASE
OGDEN, UTAH

Prepared by:

Parsons Engineering Science, Inc.
1700 Broadway, Suite 900
Denver, Colorado 80290

EXECUTIVE SUMMARY

This report presents the results of an engineering evaluation/cost analysis (EE/CA) performed by Parsons Engineering Science, Inc. (Parsons ES) [formerly known as Engineering-Science, Inc. (ES)] at Hill Air Force Base, Utah to evaluate the use of intrinsic remediation (natural attenuation) with long-term monitoring as a remedial option for dissolved-phase benzene, toluene, ethylbenzene, and xylene (BTEX) contamination in the shallow saturated zone near underground storage tank (UST) Site 870. Soil and ground water contamination is known to occur at the site, with contamination being present in the dissolved and gaseous phases, and as light nonaqueous phase liquid (LNAPL). This study focused on the impact of dissolved-phase BTEX on the shallow ground water system at the site. Site history and the results of soil and ground water investigations conducted previously are also summarized in this report.

An important component of this study was to assess the potential for BTEX dissolved in ground water to migrate from UST Site 870 to potential receptors. The Bioplume II model was used to estimate the rate and direction of dissolved-phase BTEX movement through the shallow saturated zone under the influence of advection, dispersion, sorption, and biodegradation. Input parameters used for the Bioplume II model were obtained from existing site characterization data, supplemented with data collected by Parsons ES in conjunction with personnel from the United States Environmental Protection Agency Robert S. Kerr Environmental Research Laboratory. Chemical analysis of a single LNAPL sample suggests that LNAPL contamination at the site is weathered JP-4 jet fuel. Extensive site-specific data were used as model input. Model input parameters that were not measured at the site were estimated using reasonable literature values for hydrogeologic conditions similar to those found at the site.

The results of this study suggest that dissolved-phase BTEX contamination present in ground water at UST Site 870 poses no significant risk to human health or the environment in its present, or predicted future, concentration and distribution. It is therefore recommended that intrinsic remediation with long-term monitoring be implemented for dissolved-phase BTEX contamination found in ground water at this site. To reduce sources of continuing contamination, it is also recommended that mobile LNAPL recovery operations and bioventing activities currently underway at the site be continued.

To verify Bioplume II model predictions, it is recommended that nine long-term monitoring (LTM) wells, three point-of-compliance (POC) monitoring wells, and a contingency sampling

point at the mouth of the stormwater sewer that runs along Cambridge Street be used to monitor the long-term migration and degradation of the dissolved-phase BTEX plume. Regular sampling and analysis of water from these sampling locations will allow the effectiveness of intrinsic remediation to be monitored and should allow sufficient time to implement hydraulic controls to contain the plume if BTEX is detected at the POC sampling locations. The LTM wells and POC sampling locations should be sampled on a semiannual basis for at least 13 years. If the data collected during this period supports the anticipated effectiveness of intrinsic remediation, the sampling frequency can be reduced to once every year, or eliminated. Ground water samples should be analyzed for the parameters described in Section 7 of this report. If BTEX concentrations in water from the POC sampling locations are found to exceed promulgated maximum contaminant levels, additional corrective actions should be taken to remediate ground water at the site, as described in this report.

TABLE OF CONTENTS

EXECUTIVE SUMMARY	ES-1
1.0 INTRODUCTION.....	1-1
1.1 SCOPE AND OBJECTIVES	1-1
1.2 FACILITY BACKGROUND.....	1-3
1.2.1 Operational History.....	1-6
1.2.2 Current Remedial Activities.....	1-6
2.0 SITE CHARACTERIZATION ACTIVITIES.....	2-1
2.1 DRILLING, SOIL SAMPLING, AND MONITORING WELL INSTALLATION.....	2-2
2.1.1 Well Locations and Completion Intervals.....	2-3
2.1.2 Well Drilling and Installation Procedures.....	2-3
2.1.2.1 Pre-Drilling Activities.....	2-3
2.1.2.2 Equipment Decontamination Procedures.....	2-3
2.1.2.3 Drilling and Soil Sampling.....	2-7
2.1.2.4 Monitoring Well Installation.....	2-8
2.1.2.4.1 Well Materials Decontamination.....	2-8
2.1.2.4.2 Well Casing.....	2-9
2.1.2.4.3 Well Screen.....	2-9
2.1.2.4.4 Sand Filter Pack.....	2-9
2.1.2.4.5 Annular Sealant.....	2-9
2.1.2.4.6 Flush-Mount Protective Cover.....	2-10
2.1.2.5 Well Development.....	2-10
2.1.2.6 Water Level Measurements.....	2-10
2.1.2.7 Well Location and Datum Survey.....	2-11
2.2 GROUND WATER SAMPLING.....	2-11
2.2.1 Ground Water Sampling Locations.....	2-12
2.2.1.1 Geoprobe® Sampling Locations.....	2-12
2.2.1.2 Monitoring Well Sampling Locations.....	2-13
2.2.1.3 Storm Sewer Sampling Locations.....	2-13
2.2.2 Preparation for Sampling.....	2-13
2.2.2.1 Equipment Cleaning.....	2-13
2.2.2.2 Equipment Calibration.....	2-13
2.2.3 Sampling Procedures.....	2-14
2.2.3.1 Geoprobe® Ground Water Sampling.....	2-14
2.2.3.1.1 Sampling Interval and Method.....	2-14

2.2.3.1.2	Preparation of Location.....	2-16
2.2.3.1.3	Water Level and Total Depth Measurements.....	2-16
2.2.3.1.4	Sample Extraction.....	2-16
2.2.3.1.5	Geoprobe® Equipment Decontamination.....	2-16
2.2.3.2	Ground Water Monitoring Well Sampling.....	2-17
2.2.3.2.1	Preparation of Location.....	2-17
2.2.3.2.2	Water Level and Total Depth Measurements.....	2-17
2.2.3.2.3	Well Bore Purging.....	2-17
2.2.3.2.4	Sample Extraction.....	2-17
2.2.3.3	Storm Sewer Sampling.....	2-18
2.2.4	Onsite Chemical Parameter Measurement.....	2-18
2.2.4.1	Dissolved Oxygen Measurements.....	2-18
2.2.4.2	Reduction/Oxidation Potential Measurements.....	2-18
2.2.4.3	pH, Temperature, and Specific Conductance.....	2-18
2.2.5	Sample Handling.....	2-19
2.2.5.1	Sample Preservation.....	2-19
2.2.5.2	Sample Container and Labels.....	2-19
2.2.5.3	Sample Shipment.....	2-20
2.3	AQUIFER TESTING.....	2-20
2.3.1	Slug Testing.....	2-20
2.3.1	Slug Test Data Analysis.....	2-21
2.4	SURVEYING.....	2-21
3.0	PHYSICAL CHARACTERISTICS OF THE STUDY AREA.....	3-1
3.1	SURFACE FEATURES.....	3-1
3.1.1	Topography and Surface Water Hydrology.....	3-1
3.1.2	Manmade Features.....	3-1
3.2	REGIONAL GEOLOGY AND HYDROGEOLOGY.....	3-3
3.3	SITE GEOLOGY AND HYDROGEOLOGY.....	3-3
3.3.1	Lithology and Stratigraphic Relationships.....	3-4
3.3.2	Grain Size Distribution.....	3-4
3.3.3	Ground Water Hydraulics.....	3-8
3.3.3.1	Flow Direction and Gradient.....	3-8
3.3.3.2	Hydraulic Conductivity (K).....	3-8
3.3.3.3	Effective Porosity (n_e).....	3-10
3.3.3.4	Advective Ground Water Velocity (\bar{v}).....	3-10
3.3.3.5	Preferential Flow Paths.....	3-11
3.3.5	Ground Water Use.....	3-11
3.4	CLIMATOLOGICAL CHARACTERISTICS.....	3-12

4.0 NATURE AND EXTENT OF CONTAMINATION AND SOIL AND GROUND WATER GEOCHEMISTRY	4-1
4.1 SOURCE OF CONTAMINATION.....	4-1
4.2 SOIL CHEMISTRY	4-1
4.2.1 Mobile LNAPL Contamination.....	4-1
4.2.2 Residual-Phase (Stationary) LNAPL Contamination.....	4-4
4.2.2.1 Soil BTEX Contamination	4-4
4.2.2.2 Soil TPH Contamination.....	4-4
4.2.3 Total Organic Carbon.....	4-12
4.3 GROUND WATER CHEMISTRY.....	4-13
4.3.1 Dissolved-Phase BTEX Contamination.....	4-13
4.3.2 Inorganic Chemistry and Geochemical Indicators of Biodegradation	4-21
4.3.2.1 Dissolved Oxygen.....	4-21
4.3.2.2 Nitrate/Nitrite.....	4-27
4.3.2.3 Ferrous Iron	4-30
4.3.2.4 Sulfate.....	4-33
4.3.1.5 Methane	4-37
4.3.2.6 Reduction/Oxidation Potential	4-40
4.3.2.7 Alkalinity.....	4-40
4.3.2.8 pH.....	4-43
4.3.2.9 Temperature.....	4-43
4.3.3 Expressed Assimilative Capacity.....	4-43
5.0 GROUND WATER MODEL	5-1
5.1 GENERAL OVERVIEW AND MODEL DESCRIPTION.....	5-1
5.2 CONCEPTUAL MODEL DESIGN AND ASSUMPTIONS.....	5-2
5.4 MODEL INPUT	5-3
5.4.1 Grid Design.....	5-3
5.4.2 Ground Water Elevation and Gradient.....	5-6
5.4.3 BTEX Concentrations	5-6
5.4.4 Hydraulic Conductivity.....	5-8
5.4.5 Electron Acceptors (Oxygen and Nitrate)	5-8
5.4.5 Dispersivity	5-12
5.4.6 Retardation	5-12
5.4.7 Reaeration.....	5-14
5.5 MODEL CALIBRATION.....	5-14
5.5.1 Water Table Calibration.....	5-14
5.5.2 BTEX Plume Calibration.....	5-16
5.6 SENSITIVITY ANALYSIS.....	5-18

5.7 MODEL RESULTS.....	5-23
5.7.1 No Source Removal (Model Hill-A).....	5-24
5.7.2 Five-Percent Annual Source Removal (Model Hill-B).....	5-24
5.7.3 Fifteen-Percent Annual Source Removal (Model Hill-C).....	5-27
5.9 CONCLUSIONS	5-33
6.0 COMPARATIVE ANALYSIS OF REMEDIAL ALTERNATIVES.....	6-1
6.1 REMEDIAL ALTERNATIVE EVALUATION CRITERIA	6-1
6.1.1 Long-Term Effectiveness and Permanence.....	6-1
6.1.2 Implementability.....	6-2
6.1.3 Cost	6-2
6.2 FACTORS INFLUENCING ALTERNATIVES DEVELOPMENT	6-2
6.2.1 Program Objectives	6-3
6.2.2 Contaminant Properties	6-3
6.2.3 Site-Specific Conditions	6-5
6.2.3.1 Ground Water and Soil Characteristics.....	6-5
6.2.3.2 Potential Exposure Pathways	6-7
6.2.3.3 Remediation Goals for Shallow Ground Water.....	6-9
6.2.4 Summary of Remedial Technology Screening	6-10
6.3 BRIEF DESCRIPTION OF REMEDIAL ALTERNATIVES.....	6-15
6.3.1 Alternative 1 - Continued Mobile LNAPL Removal and Bioventing in Source Area, Intrinsic Remediation, Institutional Controls with Long-Term Monitoring.....	6-15
6.3.2 Alternative 2 - Continued Mobile LNAPL Recovery and Bioventing, Intrinsic Remediation, Institutional Controls with Long-term Ground Water Monitoring, Stormwater Treatment	6-17
6.3.3 Alternative 3 - Expanded Mobile LNAPL Removal and Bioventing, Intrinsic Remediation, Institutional Controls and Long-Term Monitoring.....	6-18
6.4 EVALUATION OF ALTERNATIVES.....	6-20
6.4.1 Alternative 1 - Continued Mobile LNAPL Removal and Bioventing in Source Area, Intrinsic Remediation, Institutional Controls with Long-Term Monitoring.....	6-21
6.4.1.1 Effectiveness.....	6-21
6.4.1.2 Implementability	6-22
6.4.1.3 Cost.....	6-23
6.4.2 Alternative 2 - Continued Mobile LNAPL Recovery and Bioventing in Source Area, Intrinsic Remediation, Institutional Controls with Long-Term Ground Water Monitoring, Stormwater Treatment.....	6-23
6.4.2.1 Effectiveness.....	6-23
6.4.2.2 Implementability	6-23

6.4.2.3 Cost.....	6-24
6.4.3 Alternative 3 - Intensive Source Removal, Intrinsic Remediation, Institutional Controls and Long-Term Monitoring.....	6-25
6.4.3.1 Effectiveness.....	6-25
6.4.3.2 Implementability.....	6-27
6.4.3.3 Cost.....	6-27
6.5 RECOMMENDED REMEDIAL APPROACH.....	6-28
7.0 LONG-TERM MONITORING PLAN.....	7-1
7.1 OVERVIEW.....	7-1
7.2 MONITORING NETWORKS.....	7-1
7.2.1 Long-Term Monitoring Network.....	7-2
7.2.2 Point-of-Compliance Monitoring Network.....	7-4
7.3 GROUND WATER SAMPLING AND ANALYSIS.....	7-4
7.3.1 Analytical Protocol.....	7-5
7.3.1.1 Long-Term Monitoring Well Analytical Protocol.....	7-5
7.3.1.2 Point-Of-Compliance Monitoring Point Analytical Protocol.....	7-5
7.3.2 Frequency.....	7-5
8.0 CONCLUSIONS AND RECOMMENDATIONS.....	8-1
9.0 REFERENCES.....	9-1

APPENDICES

APPENDIX A	Boring Logs, Well Completion Diagrams, and Slug Test Results
APPENDIX B	Ground Water Elevation and LNAPL Thickness Data
APPENDIX C	Soil and Ground Water Analytical Results
APPENDIX D	Gridded Model Input and Water Table Calibration Results
APPENDIX E	Bioplume II Model Output

TABLES

No.	Title	Page
2.1	Well Completion Information	2-4
3.1	Slug Test Results.....	3-10
4.1	Comparative Fresh and Weathered LNAPL BTEX Analytical Results.....	4-3
4.2	Fuel Hydrocarbon Compounds Detected in Soil.....	4-5
4.3	Total Organic Carbon in Soil	4-12
4.4	Fuel Hydrocarbon Compounds Detected in Ground Water	4-14
4.5	Ground Water Geochemical Data	4-22
4.6	Expressed Assimilative Capacity of Site Ground Water	4-44
5.1	Bioplume II Model Input Parameters.....	5-4
5.2	Retardation Calculations for the BTEX Compounds.....	5-15
6.1	Point-Of-Compliance Remediation Goals.....	6-10
6.2	Initial Technical Implementability Screening of Technologies and Process Options for Ground Water Remediation.....	6-11
6.3	Alternative 1 - Cost Estimate.....	6-24
6.4	Alternative 2 - Cost Estimate.....	6-26
6.5	Alternative 3 - Cost Estimate.....	6-28
6.6	Summary of Remedial Alternative Evaluation	6-30
7.1	Long-Term Monitoring Analytical Protocol.....	7-6
7.2	Point-Of-Compliance Monitoring Analytical Protocol.....	7-8

FIGURES

No.	Title	Page
1.1	Regional Location Map	1-4
1.2	Site Map	1-5
2.1	Cross Section of Geoprobe.....	2-15
3.1	Storm Sewer Layout	3-2
3.2	Hydrogeologic Section Location Map	3-5
3.3	Hydrogeologic Section A-A'	3-6
3.4	Hydrogeologic Section B-B'	3-7
3.5	Ground Water Elevation Map, July/August 1993	3-9
4.1	LNAPL Isopach Map, July/August 1993	4-2

4.2	Total BTEX Isopleth for Soil	4-10
4.3	Total Petroleum Hydrocarbon Isopleth Map for Soil.....	4-11
4.4	Total BTEX Isopleth for Ground Water Through August 1993	4-19
4.5	Total BTEX Isopleth for Ground Water, July 1994	4-20
4.6	Dissolved Oxygen Isopleth For Ground Water, August 1993	4-24
4.7	Dissolved Oxygen Isopleth For Ground Water, July 1994.....	4-26
4.8	Nitrate + Nitrite Isopleth For Ground Water, August 1993	4-28
4.9	Nitrate + Nitrite Isopleth For Ground Water, July 1994	4-29
4.10	Ferrous Iron Isopleth For Ground Water, August 1993	4-31
4.11	Ferrous Iron Isopleth For Ground Water, July 1994	4-32
4.12	Sulfate Concentration in Ground Water, August 1993	4-34
4.13	Sulfate Isopleth Map Ground Water, July 1994	4-36
4.14	Methane Isopleth Map Ground Water, August 1993.....	4-38
4.15	Methane Isopleth Map Ground Water, July 1994.....	4-39
4.16	Reduction/Oxidation Potential Map, August 1993	4-41
4.17	Reduction/Oxidation Potential Map, July 1994	4-42
5.1	Model Grid Including Injection Cell Locations.....	5-5
5.2	Model Results, Total Dissolved BTEX, All Models, T=0 Year	5-7
5.3	Combined DO and Nitrate Isopleth Map, August 1993	5-13
5.4	Calibrated Water Table Elevation Map	5-17
5.5	Plot of Total BTEX versus Distance Along Plume Centerline with Varying Hydraulic Conductivity.....	5-20
5.6	Plot of Total BTEX versus Distance Along Plume Centerline with Varying Coefficient of Reaeration.....	5-21
5.7	Plot of Total BTEX versus Distance Along Plume Centerline with Varying Dispersivity	5-22
5.8	Model Results, Total Dissolved BTEX, No LNAPL Removal, T=1 year.....	5-25
5.9	Model Results, Total Dissolved BTEX, No LNAPL Removal, T=10 years .	5-26
5.10	Model Results, Total Dissolved BTEX, 5% Annual LNAPL Removal, T=1 year	5-28
5.11	Model Results, Total Dissolved BTEX, 5% Annual LNAPL Removal, T=4 years.....	5-29
5.12	Model Results, Total Dissolved BTEX, 5% Annual LNAPL Removal, T=7 years.....	5-30
5.13	Model Results, Total Dissolved BTEX, 15% Annual LNAPL Removal, T=1 year	5-31
5.14	Model Results, Total Dissolved BTEX, 15% Annual LNAPL Removal, T=3 years.....	5-32
7.1	Proposed Long-Term Monitoring Well and Point-Of-Compliance Monitoring Well Placement	7-3

SECTION 1

INTRODUCTION

This report was prepared by Parsons Engineering Science, Inc. (Parsons ES) [formerly known as Engineering Science, Inc. (ES)] and presents the results of an engineering evaluation/cost analysis (EE/CA) conducted to evaluate the use of intrinsic remediation (natural attenuation) with long-term monitoring (LTM) for remediation of fuel-hydrocarbon contamination dissolved in ground water at underground storage tank (UST) Site 870, Hill Air Force Base (AFB), Utah. Previous investigations determined that JP-4 jet fuel had been released into the soil and shallow ground water at the site. The main emphasis of the work described herein was to evaluate the potential for intrinsic degradation mechanisms to reduce dissolved-phase benzene, toluene, ethylbenzene, and xylene (BTEX) concentrations in ground water to levels that are protective of human health and the environment.

1.1 SCOPE AND OBJECTIVES

Parsons ES, in conjunction with researchers from the United States Environmental Protection Agency (USEPA) Robert S. Kerr Environmental Research Laboratory (RSKERL), was retained by the United States Air Force Center for Environmental Excellence (AFCEE) to conduct site characterization and ground water modeling in support of intrinsic remediation with LTM at UST Site 870.

The scope of work for this project included the following tasks:

- Reviewing existing hydrogeologic and soil and ground water quality data for the site;
- Conducting supplemental site characterization activities to determine the nature and extent of soil and ground water contamination and to collect geochemical data to demonstrate the occurrence of intrinsic remediation;
- Developing a conceptual hydrogeologic model of the shallow saturated zone, including the distribution of contaminants and probable contaminant pathways;
- Determining if intrinsic processes of contaminant destruction are occurring in ground water at the site;

- Performing contaminant fate and transport modeling based on site hydrogeologic conditions using the Bioplume II model;
- Evaluating a range of model input parameters to determine the sensitivity of the model to these parameters and to consider several contaminant fate and transport scenarios;
- Determining if naturally-occurring processes are sufficient to minimize BTEX plume expansion so that ground water quality standards can be met at a downgradient point of compliance (POC);
- Conduct a preliminary exposure assessment for receptors potentially exposed to fuel hydrocarbon contamination in ground water;
- Developing remedial action objectives (RAOs) and reviewing available remedial technologies;
- Using the results of modeling to recommend the most appropriate remedial option based on specific effectiveness, implementability, and cost criteria; and
- Providing a LTM plan that includes LTM and POC well locations and a sampling and analysis plan (SAP).

Site characterization methods used to evaluate intrinsic remediation included Geoprobe[®] sampling of ground water near existing cone penetrometer testing locations, soil borehole drilling, soil sample collection and analysis, monitoring well installation, and sampling and analysis of ground water from newly installed and existing monitoring wells.

Site-specific data were used to develop a fate and transport model for the site using Bioplume II and to conduct a preliminary exposure assessment. The Bioplume II model was used to simulate the movement and degradation of BTEX in the shallow saturated zone under the influence of advection, dispersion, sorption, and biodegradation. As part of the EE/CA, this modeling effort had three primary objectives: 1) to predict the future extent and concentration of a dissolved-phase contaminant plume by modeling the combined effects of advection, dispersion, sorption, and biodegradation; 2) to assess the possible risk to potential downgradient receptors by conducting a preliminary exposure assessment; and 3) to provide technical support for the intrinsic remediation with LTM remedial option at regulatory negotiations, as appropriate.

Several remedial options were evaluated as part of this EE/CA, including light nonaqueous-phase liquid (LNAPL) removal; soil vapor extraction; bioventing, hydraulic containment; and intrinsic remediation with LTM. Hydrogeologic and ground water chemical data necessary to evaluate the various remedial options were collected under this program; however, field work was designed to collect the data required by the Bioplume II model and

to support the intrinsic remediation with LTM remedial option for restoration of fuel-hydrocarbon-contaminated ground water.

This report contains nine sections, including this introduction, and five appendices. Section 2 summarizes site characterization activities. Section 3 summarizes the physical characteristics of the study area. Section 4 describes the nature and extent of soil and ground water contamination and the geochemistry of soil and ground water at the site. Section 5 describes the Bioplume II model, the site conceptual model, lists model assumptions and input parameters, and describes sensitivity analyses, model output, and the results of the Bioplume II simulations. Section 6 presents a comparative analysis of remedial alternatives. Section 7 presents the LTM plan for the site. Section 8 presents the conclusions of this investigation and provides recommendations for further work at the site. Section 9 lists the references used to develop this document. Appendix A contains boring logs, monitoring well completion diagrams, and slug test results. Appendix B contains ground water elevation data and information on the seasonal variation in ground water flow at the site. Appendix C presents soil and ground water analytical results. Appendix D contains gridded model input parameters and water table calibration results. Appendix E contains Bioplume II model output on a diskette in ASCII format.

1.2 FACILITY BACKGROUND

Hill AFB is located at 41°07'N latitude, 111°58'W longitude on a bench of the Wasatch Mountains on the edge of the Great Salt Lake Basin. UST Site 870 is located in the southwestern corner of Hill AFB, Utah. Figure 1.1 is a regional location map showing the location of UST Site 870 relative to Hill AFB and the surrounding area. Figure 1.2 is a detailed site map showing UST Site 870 and the immediately adjacent area. UST Site 870 encompasses the area immediately downgradient from and adjacent to the former location of UST 870.0. This site is referred to as Site EGSS by the Utah Division of Environmental Response and Remediation (DERR), and as Site Code ST61 under the Air Force Installation Restoration Program (IRP). For the purposes of the work described herein, UST Site 870 refers to the area shown in Figure 1.2. This area includes the base fuel tank farm which consists of nine aboveground storage tanks (ASTs) used to store JP-4 and diesel fuel. A portion of the Patriot Hills base housing area-located southwest of the AST farm, is also included with the site.

16 MI.
6 MI.

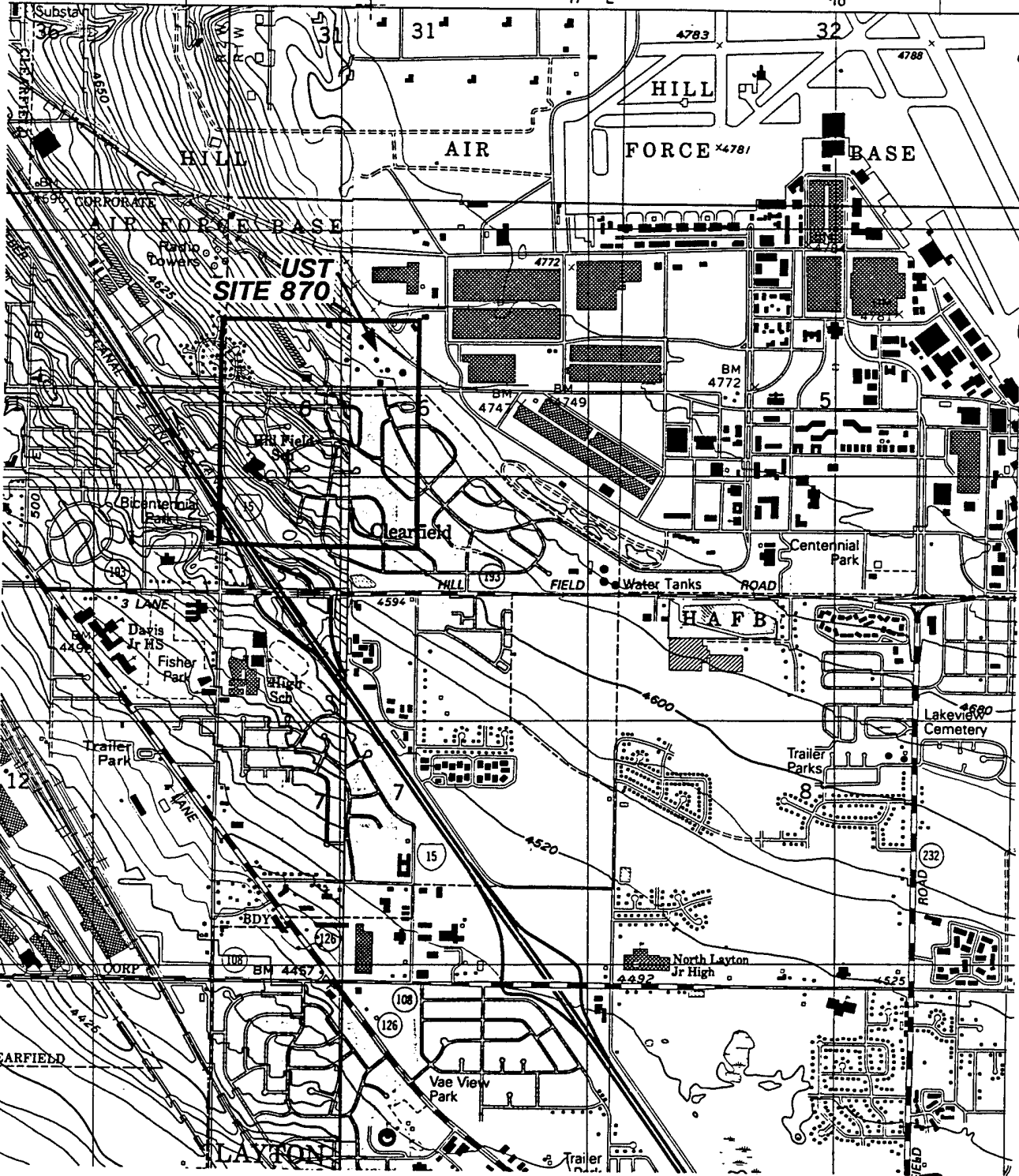

LEGEND
SCALE
 1:24,000

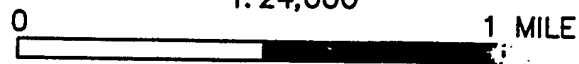

Contour Interval = 5 feet for left 1/3; 40 feet for right 2/3
 SOURCE: U.S.G.S. 7.5 Minute Quadrangle Maps: Clearfield, Utah (1991) and Kaysville, Utah (1992) Quadrangles.

FIGURE 1.1
REGIONAL LOCATION MAP
 UST Site 870
 Intrinsic Remediation EE/CA
 Hill Air Force Base, Utah

PARSONS
ENGINEERING SCIENCE, INC.
 Denver, Colorado

LEGEND

- CPT-26 ▲ CONE PENETROMETER TEST POINT/PIEZOMETER
- MW-11 ● MONITORING WELL LOCATION
- AUGUST 1993 GEOPROBE SAMPLING LOCATION
- STORM DRAIN SURVEY LOCATION
- EPA-82-N ■ JULY 1994 GEOPROBE SAMPLING LOCATION
- EPA-82-KK ◆ JULY 1994 SOIL BORING LOCATION
- EPA-82-R ○ JULY 1994 SOIL GAS LOCATION
- +++++ RAILROAD TRACKS
- - - HILL AFB BOUNDARY



FIGURE 1.2

SITE MAP

UST Site 870
Intrinsic Remediation EE/CA
Hill Air Force Base, Utah



Denver, Colorado

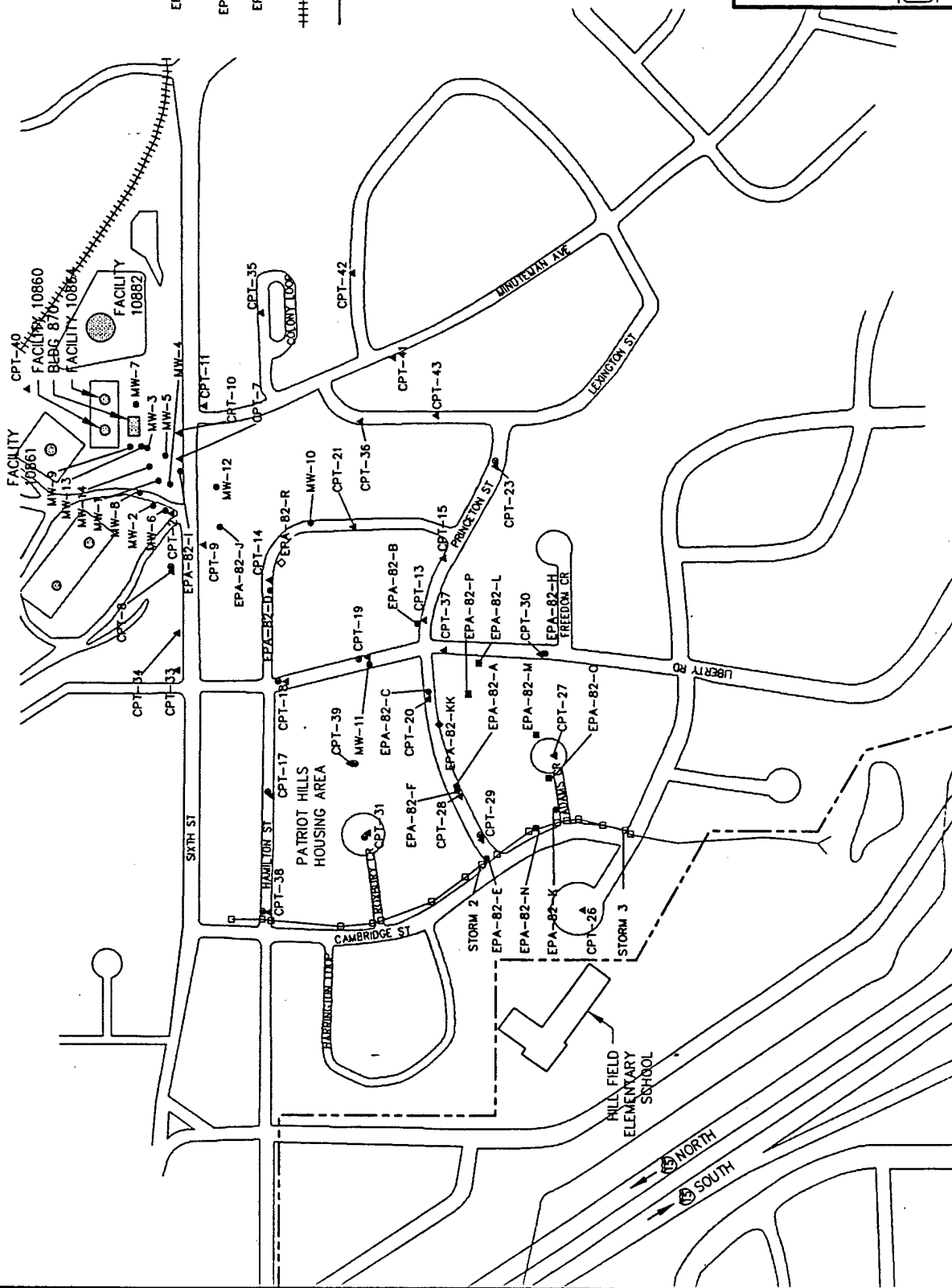

1.2.1 Operational History

UST Site 870 is located at one of the base fuel tank farms. This tank farm is bounded on the south by Sixth Street and the Patriot Hills housing area (Figure 1.2). Building 870 at the tank farm serves as the command and logistical support center for the dispensing of JP-4 to the flightlines. Several ASTs are located directly north of Building 870. The Patriot Hills housing area consists of military residential housing. Warehouses, offices, and other large structures are located east and west of the tank farm. Hill Field elementary school is located immediately southwest of the housing area near the base's southwestern property boundary.

UST 870.0 was a 1,000-gallon tank used to store condensate and off-specification JP-4 generated by activities at an adjacent filter stand. UST 870.0 was excavated and removed in May 1991 and upgraded with a new double-walled steel UST that was equipped with leak-detection equipment. The new UST serves the same purpose as UST 870.0.

Soil and ground water contamination was observed during removal of UST 870.0. Several site investigations were conducted by Montgomery-Watson, Inc. (MWI) [formerly James M. Montgomery Consulting Engineers, Inc. (JMM)] in response to this contamination. The results of these investigations are presented in several reports, including:

- Site Characterization Report (JMM, 1991)
- Free Product Letter Report (JMM, 1992a)
- Pumping Tests and Product Thickness Test Letter Report (JMM, 1992b)
- Remedial Options Letter Report (JMM, 1993a)
- Investigation Summary Report (JMM, 1993b)

The site-specific data presented in Sections 3, 4, and 5 are based on a review of these documents and on data collected by Parsons ES and researchers from the RSKERL under this program. A synopsis of site characterization activities conducted prior to implementation of the field work described in this report is provided in the 1993 Investigation Summary Report prepared by JMM (1993b).

1.2.2 Current Remedial Activities

Current remedial activities at UST Site 870 include active and passive light non-aqueous phase liquid (LNAPL) recovery. Active mobile-phase LNAPL recovery is being accomplished

using a QED[®] specific-gravity skimmer pump installed in a monitoring well and has been conducted since June 1992. Passive LNAPL recovery is also being performed in selected wells by using Soak Ease[®] absorbent pads enclosed in a stainless steel perforated bailer. To date, about 700 gallons of LNAPL has been recovered using these systems. Water and LNAPL levels are measured monthly to provide information about LNAPL thickness and ground water level fluctuations.

SECTION 2

SITE CHARACTERIZATION ACTIVITIES

To meet the requirements of the intrinsic remediation demonstration, several investigative techniques, including soil and ground water sampling and aquifer testing, were utilized. Soil sampling was accomplished during this investigation using modified hollow-stem auger (HSA) drilling in conjunction with continuous solid-barrel sampling. Previous investigations conducted at the site utilized standard HSA drilling and soil sampling as well as cone penetrometer testing (CPT). Geoprobe[®] sampling apparatus and newly installed and previously existing monitoring wells were used to collect ground water samples during this investigation. Previous investigations utilized monitoring wells installed in HSA boreholes and monitoring points installed in CPT holes to sample ground water. Aquifer tests conducted at the site included pumping and slug testing.

This section presents the methods used by Parsons ES and researchers from the RSKERL to collect site-specific data at Hill AFB, Utah. Site characterization data obtained under this program were collected in four phases. Phase one consisted of collecting shallow ground water samples using a Geoprobe[®]. Phase two consisted of continuous soil boring and sampling, ground water monitoring well installation and sampling, and aquifer testing. Phase three consisted of collecting ground water samples from existing monitoring wells. Phase four consisted of continuous soil boring and sampling, ground water monitoring well installation and sampling, and ground water sampling using a Geoprobe[®]. In addition to the work conducted under this program, MWI collected soil and ground water data on numerous occasions (JMM, 1993b; MWI, MWI, 1994a; MWI, 1994b). Data collected under this program and data collected by MWI were integrated to develop the conceptual site model and to aid interpretation of the physical setting (Section 3) and contaminant distribution (Section 4).

The physical and chemical hydrogeologic data listed below were collected during the field work phase of the EE/CA:

- Depth from measurement datum to the water table or potentiometric surface in monitoring wells and monitoring points;
- Depth from measurement datum to the base of the shallow saturated zone;
- Location of potential ground water recharge and discharge areas;
- Hydraulic conductivity as determined from slug test data;
- Detailed stratigraphic analysis of subsurface media;
- Estimation of extent and thickness of mobile-phase LNAPL;
- Dissolved oxygen, nitrate, ferrous iron, sulfate, methane, chloride, ammonia, and total organic carbon (TOC) concentrations in ground water;
- Temperature, specific conductance, reduction/oxidation (redox) potential, total alkalinity, and pH of ground water;
- BTEX, trimethylbenzene, and total petroleum hydrocarbon (TPH) concentrations in ground water;
- BTEX, trimethylbenzene, and TPH concentrations in soil;
- TOC concentrations in select soil samples; and
- Chemical analysis of free product to determine the mass fraction of BTEX;

The following sections describe the procedures followed when collecting site-specific data. The applied drilling, soil sampling, lithologic logging, and monitoring well development procedures are described in Section 2.1. Ground water sampling procedures are described in Section 2.2. Aquifer testing procedures are described in Section 2.3.

2.1 DRILLING, SOIL SAMPLING, AND MONITORING WELL INSTALLATION

Drilling, soil sampling, and monitoring well installation were accomplished in two phases under this program. Phase one occurred during the week of 16 August 1993, and consisted of drilling, soil sampling, and monitoring well installation at EPA-82-A, EPA-82-B, EPA-82-C, EPA-82-D, EPA-82-E, EPA-82-F, EPA-82-H, and EPA-82-I (Figure 1.2). Phase two occurred during the week of 4 July 1994, and consisted of drilling and soil sampling at EPA-82-J and EPA-82-K, and monitoring well installation at EPA-82-J. Drilling, soil sampling, and monitoring well installation were accomplished using the procedures described in the following sections.

2.1.1 Well Locations and Completion Intervals

Nine new ground water monitoring wells were installed to help characterize the shallow ground water flow system UST Site 870. These wells are identified as EPA-82-A, EPA-82-B, EPA-82-C, EPA-82-D, EPA-82-E, EPA-82-F, EPA-82-H, EPA-82-I, and EPA-82-J. The new monitoring wells were installed in the locations shown on Figure 1.2. The well locations were selected to provide the hydrogeologic data necessary for successful implementation of the Bioplume II model and to support intrinsic remediation. Table 2.1 presents well completion details.

2.1.2 Well Drilling and Installation Procedures

This section describes the procedures used for drilling and installation of new monitoring wells. All new monitoring wells were installed in accordance with general procedures outlined in Section 8.5 of *A Compendium of Superfund Field Methods* (USEPA, 1987).

2.1.2.1 Pre-Drilling Activities

All necessary digging, drilling, and ground water monitoring well installation permits were obtained prior to mobilizing to the field. In addition, all utility lines were located and proposed drilling locations were cleared prior to any drilling activities.

Water used in drilling, equipment cleaning, or grouting were obtained from an onsite potable water supply. Water use approval was verified by contacting the appropriate facility personnel.

2.1.2.2 Equipment Decontamination Procedures

Prior to arriving at the site, and between each drilling location, the drill rig, augers, drilling rods, bits, casing, samplers, tools, and other downhole equipment were decontaminated using a high-pressure, steam/hot water wash. Only potable water was used for decontamination.

During drilling operations, the drill rig, augers, and any downhole drilling and/or sampling equipment were decontaminated at the north end of the industrial waste treatment plant (IWTP) at Hill AFB. Water from the decontamination operations was allowed to collect in

TABLE 2.1
WELL COMPLETION INFORMATION
UST SITE 870 INTRINSIC REMEDIATION EE/CA
HILL AFB, UTAH

WELL NUMBER	EASTING**	NORTHING***	DATUM* ELEVATION (ft. msl)	GROUND ELEVATION (ft. msl)	TOTAL DEPTH (ft. btoc)	INNER WELL DIAMETER (inches)	SCREEN LENGTH (feet)	DEPTH TO SCREEN (ft. btoc)		SCREEN ELEVATION (feet)	
								TOP	BASE	TOP	BASE
PREVIOUSLY EXISTING MONITORING WELLS											
MW-1	2475.32	3841.98	4683.91	4684.24	28.20	4.00	10.00	18.00	28.00	4665.91	4655.91
MW-2	2389.21	3846.24	4684.39	4681.89	27.90	4.00	10.00	15.00	25.00	4669.39	4659.39
MW-3	2533.09	3882.19	4690.67	4688.43	37.24	6.00	20.00	15.00	35.00	4675.67	4655.67
MW-4	2446.70	3798.05	4682.13	4682.56	24.68	6.00	10.00	14.00	24.00	4668.13	4658.13
MW-5	2536.47	3813.49	4686.76	4687.17	27.39	4.00	10.00	17.50	27.50	4669.26	4659.26
MW-6	2389.06	3794.35	4679.03	4679.34	29.34	4.00	10.00	20.00	30.00	4659.03	4649.03
MW-7	2621.27	3900.79	4693.80	4691.85	40.20	4.00	10.00	28.00	38.00	4665.80	4655.80
MW-8	2449.70	3893.96	4688.02	4686.66	29.72	2.00	10.00	20.00	30.00	4668.02	4658.02
MW-9	2529.21	3930.05	4692.09	4689.68	36.65	2.00	20.00	15.00	35.00	4677.09	4657.09
MW-10	2354.84	3397.60	4662.67	4662.95	44.94	6.00	20.50	25.00	45.50	4637.67	4617.17
MW-11	1923.08	3213.91	4637.37	4637.58	45.32	6.00	20.50	25.00	45.50	4612.37	4591.87
MW-12	2457.72	3650.34	4676.87	4677.35	44.80	6.00	20.50	24.50	45.00	4652.37	4631.87
NEWLY INSTALLED MONITORING WELLS											
EPA-82-A	1546.62	2945.10	4606.35	4606.01	30.40	2.00	5.00	25.00	30.00	4581.35	4576.35
EPA-82-B	2062.23	3063.44	4633.28	4632.99	30.45	2.00	10.00	20.05	30.05	4613.23	4603.23
EPA-82-C	1840.49	3035.78	4625.17	4624.92	24.75	2.00	5.00	19.35	24.35	4605.82	4600.82
EPA-82-D	2167.57	3507.69	4655.39	4655.13	29.81	2.00	10.00	19.41	29.41	4635.98	4625.98
EPA-82-E	1345.36	2845.36	4600.13	4599.74	9.32	2.00	5.00	3.92	8.92	4596.21	4591.21
EPA-82-F	1543.19	2943.57	4606.19	4605.89	9.30	2.00	5.00	3.90	8.90	4602.29	4597.29
EPA-82-H	1964.51	2719.71	4610.81	4610.57	24.50	2.00	15.00	9.10	24.10	4601.71	4586.71
EPA-82-I	2520.42	3771.26	4683.08	4682.80	23.25	2.00	5.00	17.85	22.85	4665.23	4660.23
EPA-82-J	2398.75	3645.85	4675.82	4676.17	32.30	2.00	10.00	22.30	32.30	4653.52	4643.52
MW-13	2573.50	3896.74	4689.21	4689.56	35.00	7.25	10.00	10.00	35.00	4679.21	4654.21
MW-14	2548.14	3861.96	4686.21	4686.53	35.00	7.25	10.00	10.00	35.00	4676.21	4651.21
PIEZOMETERS											
CPT-2	NA	NA	NA	NA	27.00	0.50	5.00	22.00	27.00	NA	NA
CPT-3	NA	NA	NA	NA	26.00	0.50	5.00	21.00	26.00	NA	NA
CPT-4	NA	NA	NA	NA	27.60	0.50	5.00	22.60	27.60	NA	NA
CPT-6	NA	NA	NA	NA	24.00	0.50	5.00	19.00	24.00	NA	NA
CPT-7	2547.88	3772.45	4684.21	4684.37	23.85	0.50	5.00	18.85	23.85	4665.36	4660.36

TABLE 2.1 (Continued)
 WELL COMPLETION INFORMATION
 UST SITE 870 INTRINSIC REMEDIATION EE/CA
 HILL AFB, UTAH

WELL NUMBER	EASTING**	NORTHING***	DATUM* ELEVATION (ft msl)	GROUND ELEVATION (ft msl)	TOTAL DEPTH (ft btoc)	INNER WELL DIAMETER (inches)	SCREEN LENGTH (feet)	DEPTH TO SCREEN (ft btoc)		SCREEN ELEVATION (feet)	
								TOP	BASE	TOP	BASE
PIEZOMETERS (Continued)											
CPT-10	2602.28	3772.04	4686.54	4686.80	25.50	0.50	5.00	20.50	25.50	4666.04	4661.04
CPT-11	NA	NA	NA	NA	30.25	0.50	5.00	25.25	30.25	NA	NA
CPT-12	2354.84	3397.60	4662.67	4662.95	NA	0.50	5.00	NA	NA	NA	NA
CPT-13	2062.91	3060.14	4633.21	4633.43	24.00	0.50	5.00	19.00	24.00	4614.21	4609.21
CPT-14	2182.60	3507.60	4655.88	4656.10	28.28	0.50	5.00	23.28	28.28	4632.60	4627.60
CPT-15	2262.51	2985.53	4638.74	4638.92	35.40	0.50	5.00	30.40	35.40	4608.34	4603.34
CPT-17	1528.38	3493.12	4635.28	4635.51	14.41	0.50	5.00	9.41	14.41	4625.87	4620.87
CPT-18	1885.05	3457.77	4641.46	4641.82	15.09	0.50	5.00	10.09	15.09	4631.37	4626.37
CPT-19	1948.46	3037.59	4636.98	4637.31	33.35	0.50	5.00	28.35	33.35	4608.63	4603.63
CPT-20	1848.28	3244.25	4625.48	4625.69	28.20	0.50	5.00	23.20	28.20	4602.28	4597.28
CPT-21	2349.56	NA	4655.91	4656.26	34.15	0.50	5.00	29.15	34.15	4626.76	4621.76
CPT-22	NA	NA	NA	NA	25.35	0.50	5.00	20.35	25.35	NA	NA
CPT-23	2526.12	2835.21	4642.49	4642.69	31.00	0.50	5.00	26.00	31.00	4616.49	4611.49
CPT-25	NA	NA	NA	NA	38.00	0.50	5.00	33.00	38.00	NA	NA
CPT-26	1208.02	2573.01	4591.94	4592.20	12.30	0.50	5.00	7.30	12.30	4584.64	4579.64
CPT-27	1662.55	2660.73	4604.04	4604.32	10.00	0.50	5.00	5.00	10.00	4599.04	4594.04
CPT-28	1538.79	2939.72	4605.62	4605.96	7.77	0.50	5.00	2.77	7.77	4602.85	4597.85
CPT-29	1400.23	2863.23	4600.67	4600.89	7.00	0.50	5.00	2.00	7.00	4598.67	4593.67
CPT-30	1963.38	2711.28	4610.22	4610.48	15.35	0.50	5.00	10.35	15.35	4599.87	4594.87
CPT-31	1418.19	3205.92	4610.88	4611.15	10.35	0.50	5.00	5.35	10.35	4605.53	4600.53
CPT-33	NA	NA	NA	NA	NA	0.50	5.00	NA	NA	NA	NA
CPT-34	NA	NA	NA	NA	21.90	0.50	5.00	16.90	21.90	NA	NA
CPT-36	2670.91	3231.11	4669.78	4670.01	35.00	0.50	5.00	30.00	35.00	4639.78	4634.78
CPT-37	1970.30	2978.15	4625.35	4625.60	27.50	0.50	5.00	22.50	27.50	4602.85	4597.85
CPT-38	1177.69	3504.76	4615.66	4615.90	14.55	0.50	5.00	9.55	14.55	4606.11	4601.11
CPT-40	2758.65	4145.21	4715.46	4715.05	55.33	0.50	20.00	35.33	55.33	4680.13	4660.13
CPT-41	2857.64	3142.16	4675.19	4675.41	40.05	0.50	5.00	35.05	40.05	4640.14	4635.14
CPT-42	3067.32	3238.57	4678.34	4678.49	39.73	0.50	5.00	34.73	39.73	4643.61	4638.61
CPT-43	2683.44	3014.06	4659.74	4660.02	37.60	0.50	5.00	32.60	37.60	4627.14	4622.14
CPT-44	NA	NA	NA	NA	41.00	0.50	5.00	36.00	41.00	NA	NA

TABLE 2.1 (Concluded)

WELL COMPLETION INFORMATION
 UST SITE 870 INTRINSIC REMEDIATION EE/CA
 HILL AFB, UTAH

WELL NUMBER	EASTING**	NORTHING***	DATUM* ELEVATION (ft msl)	GROUND ELEVATION (ft msl)	TOTAL DEPTH (ft btoc)	INNER WELL DIAMETER (inches)	SCREEN LENGTH (feet)	DEPTH TO SCREEN (ft btoc)		SCREEN ELEVATION (feet)	
								TOP	BASE	TOP	BASE
GEOPROBE											
EPA-82-K	1458.62	2656.22	4598.38	4598.38	9.64	0.25	****	9.64	9.64	4588.74	4588.74
EPA-82-L1	-8055.75	2834.32	4614.15	4614.15	18.80	0.25	1.50	17.30	18.80	4596.85	4595.35
EPA-82-L2	-8055.75	2834.32	4614.15	4614.15	21.80	0.25	1.50	20.30	21.80	4593.85	4592.35
EPA-82-L3	-8055.75	2834.32	4614.15	4614.15	24.80	0.25	1.50	23.30	24.80	4590.85	4589.35
EPA-82-M	1700.5	2698.09	4605.01	4605.01	12.00	0.25	****	12.00	12.00	4593.01	4593.01
EPA-82-M duplicate	1700.5	2698.09	4605.01	4605.01	12.00	0.25	****	12.00	12.00	4593.01	4593.01
EPA-82-N	NA	2738.09	4599.81	4599.81	8.00	0.25	****	8.00	8.00	4591.81	4591.81
EPA-82-O	1594.5	2688.82	4602.30	4602.30	9.80	0.25	****	9.80	9.80	4592.50	4592.50
EPA-82-P	1776.37	2865.35	4612.65	4612.65	19.00	0.25	****	19.00	19.00	4593.65	4593.65

* Datum is top of PVC well casing

** For absolute easting coordinates add 1,860,000 to these numbers

*** For absolute northing coordinates add 280,000 to these numbers

**** Sample collected from end of polyethylene tubing

ft btoc = Feet below top of PVC well casing

ft msl = Feet above mean sea level

NA = Data not available

the decontamination pad collection tanks. Precautions were taken to minimize any impact to the area surrounding the decontamination pad that might result from the decontamination operations.

All sampling tools were cleaned onsite prior to use and between each sampling event with a clean water/phosphate-free detergent mix and a clean water rinse. All well completion materials were factory sealed. All decontamination activities were conducted in a manner so that the excess water was controlled and not allowed to flow into any open borehole.

Fuel, lubricants, and other similar substances were handled in a manner consistent with accepted safety procedures and standard operating practices. Well completion materials were not stored near or in areas which could be affected by these substances.

2.1.2.3 Drilling and Soil Sampling

Drilling was accomplished by using the HSA method, modified with a hinged door on the lead auger. The use of the hinged door facilitated collection of representative soil samples over the entire range of contamination. The borings were drilled and continuously sampled to the proposed total depth of the monitoring well. A final borehole diameter of at least 8 inches (with the exception of EPA-82-J, which used a 6-inch boring) was used for the installation of wells with a 2-inch inside-diameter (ID) casing.

Continuous soil samples were obtained using a 3-inch-ID solid-barrel continuous sampling device. Samples were collected continuously over the full depth of the soil borehole. The soil samples collected were removed from the continuous sampler in 0.3-foot intervals and placed in clean glass jars for laboratory analysis. In addition, a portion of the soil sample was placed in a clean glass jar for photoionization detector (PID) headspace measurements for volatile organic compounds (VOCs) and lithologic logging. Representative portions of the soil samples collected for the headspace procedure were quickly transferred to clean glass jars, sealed with aluminum foil, and held for 15 minutes at an ambient temperature of 65 degrees Fahrenheit (°F) or greater. Semiquantitative measurements were made by puncturing the aluminum foil seal with the PID probe and reading the concentration of the headspace gases. The PID relates the concentration of total VOCs in the sample to an isobutylene calibration standard. The PID was also used to monitor the worker breathing zone.

The Parsons ES field hydrogeologist observed drilling and well installation activities, maintained a detailed descriptive log of subsurface materials recovered, and photographed representative samples. Final geologic boring logs are presented in Appendix A. These logs contain:

- Sample interval (top and bottom depth);
- Presence or absence of contamination based on odor, staining, and/or PID readings;
- Soil description, including color, major textural constituents, minor constituents, relative moisture content, plasticity of fines, cohesiveness, grain size, structure or stratification, relative permeability, and any other significant observations; and
- Lithologic contacts with the depth of lithologic contacts and/or significant textural changes recorded to the nearest 0.1 foot (1 inch).

Soils exhibiting petroleum hydrocarbon contamination based on PID screening were drummed and stored onsite during the drilling operations. Upon completion of the drilling activities, two composite samples from the contaminated soil drums were collected and analyzed by USEPA Methods SW8020 and SW8015 modified. Upon receipt of the soil analytical results, these soils were transferred for disposal to E.T. Technologies, Inc. in Salt Lake City, Utah by Hill AFB personnel. Clean soils were handled by Hill AFB personnel who were responsible for the final disposition of these soils.

2.1.2.4 Monitoring Well Installation

Ground water monitoring wells were installed in nine soil borings under this program. Detailed well installation procedures are described in the following paragraphs. Well completion diagrams are included in Appendix A.

2.1.2.4.1 Well Materials Decontamination

Well completion materials were inspected by the field hydrogeologist and determined to be clean and acceptable prior to use. All well completion materials were factory sealed. Pre-packaged sand, bentonite, and Portland[®] cement were used in well construction, and the bags were inspected for possible external contamination before use. Materials that could not be cleaned to the satisfaction of the field hydrogeologist were not used.

2.1.2.4.2 Well Casing

Upon completion of drilling, a monitoring well casing was installed. Well construction details were noted on a Monitoring Well Installation Record form. This information became part of the permanent field record for the site and is included in Appendix A.

Blank well casing was constructed of Schedule 40 polyvinyl chloride (PVC) with an ID of 2 inches. All well casing sections were flush-threaded, and glued joints were not used. The casing at each well was fitted with a threaded bottom plug and a top cap constructed of the same type of material as the well casing. The top cap was vented to maintain ambient atmospheric pressure within the well casing.

The field hydrogeologist verified and recorded the boring depth, the lengths of all casing sections, and the depth to the top of all well completion materials placed in the annulus between the casing and borehole wall. All lengths and depths were measured to the nearest 0.1 foot.

2.1.2.4.3 Well Screen

Well screens were constructed of flush-threaded, Schedule 40 PVC with an ID of 2 inches. The screens were factory slotted with 0.010-inch openings. Each well was screened so that seasonal fluctuations of the water table can be measured. Except where specified, the entire thickness of the sand interval of the shallow aquifer was screened. The position of the screen was selected by the field hydrogeologist after consideration was given to the geometry and hydraulic characteristics of the stratum in which the wells were screened.

2.1.2.4.4 Sand Filter Pack

A graded sand filter was placed around the screened interval from the bottom of the casing to approximately 2 feet above the top of the screen. Number 10-20 Colorado silica sand was used for the sand filter pack.

2.1.2.4.5 Annular Sealant

An annular seal of sodium bentonite pellets was placed above the sand pack. The pellet seal was a minimum of 2 feet thick and was hydrated in place with potable water. In wells EPA-82-A, EPA-82-B, EPA-82-C, EPA-82-D, EPA-82-E, EPA-82-F, EPA-82-H, and EPA-

82-I, the pellet seal was overlaid with a Portland[®] cement/sodium bentonite grout that extends from the top of the pellet seal to approximately 4.5 feet below ground surface (bgs). The Portland[®] cement/sodium bentonite grout mix consisted of one 94-pound sack of cement and about 5 pounds of bentonite for each 7 gallons of water used. The bentonite content of the grout did not exceed 8 percent by dry weight. In well EPA-82-J, Baroid[®] 3/8 bentonite chips were placed in the borehole from the top of the sand pack to approximately 4.8 feet bgs. The grout or bentonite chips were overlaid with concrete that extends to the ground surface.

2.1.2.4.6 Flush-Mount Protective Cover

Each monitoring well was completed with an at-grade protective cover. In areas with pavement, the at-grade covers were cemented in place using concrete blended to the existing pavement. All wells were completed with concrete pads that slope gently away from the protective casing to facilitate runoff during precipitation events.

2.1.2.5 Well Development

Before being sampled, newly installed monitoring wells were developed. Well development removes sediment from inside the well casing and flushes fines, cuttings, and drilling fluids from the sand pack and the portion of the formation adjacent to the well screen.

Well development was accomplished using a peristaltic pump. The pump tubing was regularly lowered to the bottom of the well so that fines were agitated and removed from the well in the development water. Development was continued until a minimum of 10 casing volumes of water were removed from the well and the pH, temperature, specific conductivity, dissolved oxygen (DO) concentration, and redox potential of the ground water had stabilized. All well development waters were collected in 55-gallon drums and transported to the Hill AFB IWTP for treatment and disposal.

2.1.2.6 Water Level Measurements

Water levels at all sampled monitoring wells were measured. Measurements were made using an electric water level probe capable of recording to the nearest 1/8 inch (0.01 foot). In addition, water level measurements were made in select piezometers and previously existing monitoring wells at the site.

2.1.2.7 Well Location and Datum Survey

The location and elevation of the new wells were surveyed by a registered surveyor soon after well completion. The horizontal location were measured relative to established Hill AFB coordinates. Horizontal coordinates were measured to the nearest 1 foot. Vertical location of the ground surface adjacent to the well casing and the measurement datum (top of the PVC well casing) were measured relative to a US Geological Survey (USGS) mean sea level datum. The ground surface elevation was measured to the nearest 0.1 foot, and the measurement datum elevation was measured to the nearest 0.01 foot.

2.2 GROUND WATER SAMPLING

This section describes the procedures used for collecting ground water quality samples. In order to maintain a high degree of quality control during this sampling event, the procedures described in the following sections were followed.

Ground water samples were collected in four phases under this program. Phase one occurred during the week of 2 August 1993, and consisted of collecting ground water samples near existing CPT locations using a Geoprobe®. This ground water sampling process is described in Section 2.2.3.1. The second phase of ground water sampling occurred during the week of 16 August 1993, and consisted of collecting ground water samples from monitoring wells and water samples from the stormwater drain. The procedures used to sample ground water monitoring wells are described in Section 2.2.3.2. The third phase of ground water sampling occurred during the week of 8 November 1993, and consisted of sampling ground water monitoring wells. The fourth phase of ground water sampling occurred during the week of 4 July 1994, and consisted of collecting ground water samples from monitoring wells and by using a Geoprobe®. In addition to the sampling events conducted under this program, several ground water sampling events have been conducted by MWI at this site.

Activities that occurred during ground water sampling are summarized below:

- Assembly and preparation of equipment and supplies;
- Inspection of the well integrity (for monitoring well sampling), including
 - Protective cover, cap and lock,
 - External surface seal and pad,
 - Datum reference, and

- Internal surface seal;
- Ground water sampling, including
 - Water level measurements,
 - Visual inspection of water,
 - Well casing or Geoprobe® point evacuation, and
 - Sampling;
- Sample preservation and shipment, including
 - Sample preparation,
 - Onsite measurement of physical parameters, and
 - Sample labeling and packing;
- Completion of sampling records;
- Completion of chain-of-custody records; and
- Sample disposition.

Detailed ground water sampling and sample handling procedures that were used are presented in following sections.

2.2.1 Ground Water Sampling Locations

Ground water samples were collected from existing and newly installed monitoring wells, from Geoprobe® ground water sampling equipment, and at accessible locations along the storm sewer.

2.2.1.1 Geoprobe® Sampling Locations

Ground water samples were collected using the Geoprobe® sampling apparatus near nine existing CPT locations (CPT-8, CPT-17, CPT-18, CPT-19, CPT-23, CPT-29, CPT-31, CPT-38, and CPT-39) during the week of 2 August 1994. During the week of 4 July 1994, ground water samples were collected using the Geoprobe® sampling apparatus at points EPA-82-K, EPA-82-L, EPA-82-M, EPA-82-N, EPA-82-O, and EPA-82-P. Geoprobe® sampling locations are shown in Figure 1.2.

2.2.1.2 Monitoring Well Sampling Locations

Nine new monitoring wells were installed in the locations shown on Figure 1.2. After completion of well installation and development activities, these wells were sampled using a peristaltic pump with dedicated polyethylene tubing. Previously existing monitoring wells were also sampled under this program.

2.2.1.3 Storm Sewer Sampling Locations

Water samples were collected from accessible locations along the storm sewer system shown on Figure 1.2. These samples are labeled storm-2 and storm-3.

2.2.2 Preparation for Sampling

All equipment used for sampling was assembled and properly cleaned and calibrated (if required) prior to arriving in the field. In addition, all record keeping materials were gathered prior to leaving the office.

2.2.2.1 Equipment Cleaning

All portions of sampling and test equipment that contacted the sample were thoroughly cleaned before use. This equipment included water level probe and cable, lifting line, test equipment for onsite use, and other equipment that contacted the samples. The following cleaning protocol was used:

- Cleaned with potable water and phosphate-free laboratory detergent;
- Rinsed with potable water;
- Rinsed with distilled or deionized water;
- Rinsed with reagent-grade acetone;
- Air dried prior to use.

2.2.2.2 Equipment Calibration

As required, field analytical equipment were calibrated according to the manufacturer's specifications prior to field use. This applied to equipment used for onsite chemical measurements of DO, redox potential, pH, specific conductivity, and temperature.

2.2.3 Sampling Procedures

Special care was taken to prevent contamination of the ground water and extracted samples through cross contamination from improperly cleaned equipment. Water level probes and cable used to determine static water levels and well total depths were thoroughly cleaned before and after field use and between uses at different sampling locations according to the procedures presented in Section 2.2.2.1. In addition, a clean pair of new, disposable nitrile gloves was worn each time a different well was sampled.

2.2.3.1 Geoprobe® Ground Water Sampling

The Geoprobe® system is a hydraulically powered percussion/probing machine used to advance sampling tools through unconsolidated soils. This system provides for the rapid collection of ground water (and soil and soil gas if necessary) samples at shallow depths while minimizing the generation of investigation-derived waste materials. Figure 2.1 is a diagram of the Geoprobe® system. The following sections describe the ground water sample collection methods and decontamination methods using the Geoprobe® system.

2.2.3.1.1 *Sampling Interval and Method*

Based on the anticipated ground water elevation, the sampling depth and interval were estimated prior to driving the Geoprobe® sampling rods into the ground. The Parsons ES field hydrogeologist verified the sampling depth by measuring the length of each Geoprobe® sampling rod prior to insertion into the ground. A disposable drive tip was placed at the tip of the Geoprobe® sampling rods. This tip was threaded on the uphole end to allow attachment of 3/8-inch, high-density polyethylene (HDPE) tubing. After reaching the desired depth, HDPE tubing was threaded through the center of the hollow Geoprobe® sampling rod and secured to the drive point. The tubing was perforated at the downhole end using a 1/16-inch drill bit at 1/4-inch intervals alternately offset at 90 degree angles. The Geoprobe®

**MACHINE IN
VERTICAL OPERATING
POSITION**

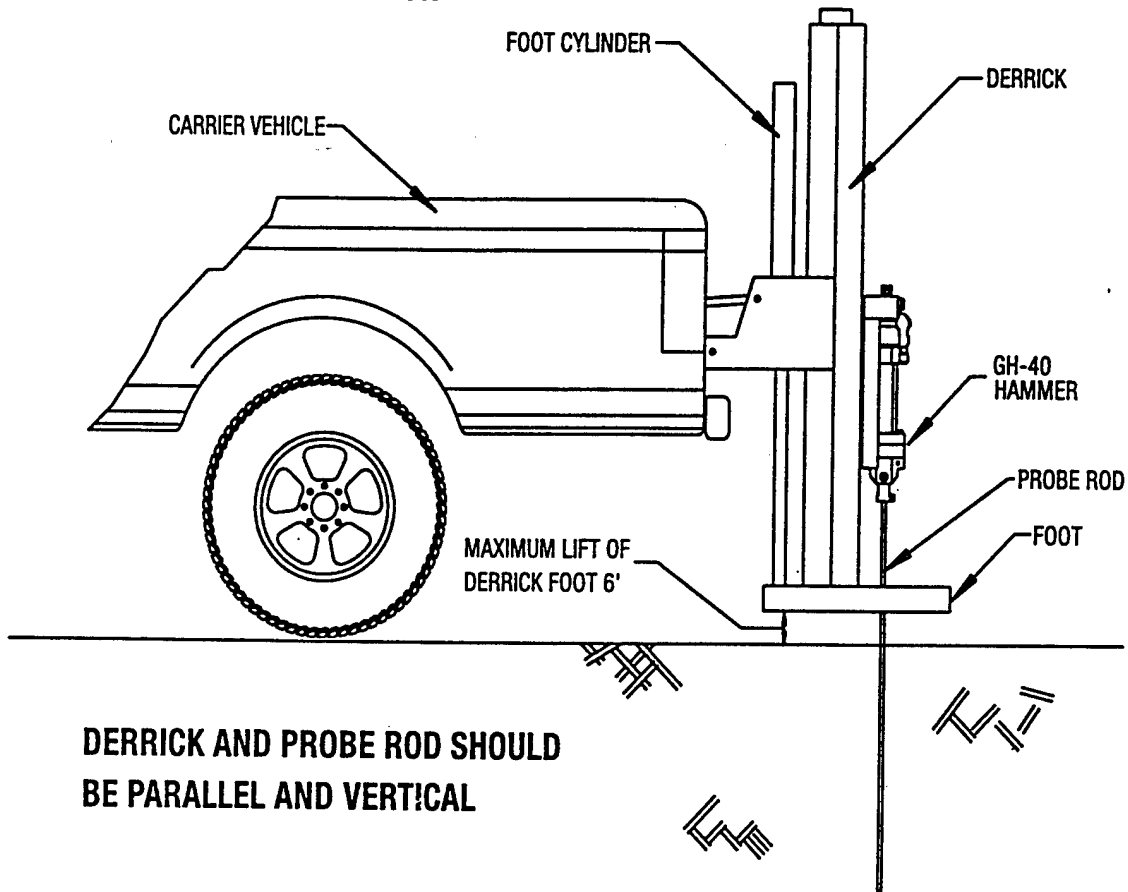

**DERRICK AND PROBE ROD SHOULD
BE PARALLEL AND VERTICAL**

FIGURE 2.1

**CROSS-SECTION OF
GEOPROBE**

UST Site 870
Intrinsic Remediation EE/CA
Hill Air Force Base, Utah



**PARSONS
ENGINEERING SCIENCE, INC.**

Denver, Colorado

Source: Geoprobe Systems®, 1994.

sampling rod was then pulled back approximately 1 foot to allow ground water to enter the perforated end of the polyethylene tubing. When the rod was pulled up, the sampling tip remained at the probe termination depth, and the 1-foot perforated interval of the polyethylene tubing was exposed to ground water. Ground water samples were then acquired using a peristaltic pump, as described in Section 2.2.3.1.4.

2.2.3.1.2 Preparation of Location

Prior to sampling, the area around the well was cleared of foreign materials, such as brush, rocks, and debris. This prevented sampling equipment from inadvertently contacting foreign materials near the sampling point.

2.2.3.1.3 Water Level and Total Depth Measurements

Prior to removing any water from the Geoprobe® sampling location the static water level was measured. A manometer with hollow HDPE tubing was inserted into the HDPE tubing through which the ground water sample was acquired until positive pressure on the manometer indicated that ground water was reached. The manometer tube was then marked at the level of the ground surface and removed from the ground. Depth to water was determined by placing a tape measure next to the HDPE tubing and measuring the length from the base of the tubing to the ground level mark to the nearest 0.1 foot. Sampling depth was measured to the nearest 0.1 foot by noting the length of each section of Geoprobe® sampling rod placed in the ground.

2.2.3.1.4 Sample Extraction

A peristaltic pump was used to extract ground water samples from the Geoprobe® sampling point. Prior to sample collection, ground water was purged until DO and temperature readings stabilized. The samples were transferred directly to the appropriate sample container. The water was carefully poured down the inner walls of the sample bottle to minimize aeration of the sample.

2.2.3.1.5 Geoprobe® Equipment Decontamination

All geoprobe rids, tips, or other downhole equipment were decontaminated with a high-pressure, steam/hot water wash. Enough linear feet of Geoprobe® rods and Geoprobe® tips

were available that decontamination procedures were minimized to every fourth or fifth Geoprobe® sampling location. Only potable water was used for decontamination. Collection of waters and decontamination of sampling tools is as described in Section 2.1.2.2.

2.2.3.2 Ground Water Monitoring Well Sampling

2.2.3.2.1 *Preparation of Location*

Prior to starting the sampling procedure, the area around the well was cleared of foreign materials, such as brush, rocks, and debris. These procedures prevented sampling equipment from inadvertently contacting debris around the monitoring well.

2.2.3.2.2 *Water Level and Total Depth Measurements*

Prior to removing any water from the well the static water level was measured. An electric water level probe was used to measure the depth to ground water below the datum to the nearest 0.01 foot. After measurement of the static water level, the water level probe was lowered to the bottom of the well for measurement of total well depth (recorded to the nearest 0.01 foot). Based on these measurements, the volume of water purged from the wells was calculated.

2.2.3.2.3 *Well Bore Purging*

Three times the calculated casing volume was removed from each well prior to sampling. All purge water was placed in 55-gallon drums and transported to the Hill AFB IWTP for disposal and treatment. The empty drums were rinsed with hot water and returned to base personnel for reuse. A peristaltic pump with dedicated Teflon®-lined polyethylene tubing was used for well evacuation.

2.2.3.2.4 *Sample Extraction*

A peristaltic pump with dedicated Teflon®-lined polyethylene tubing was used to extract ground water samples from the well. The sample was transferred directly to the appropriate sample container. The water was carefully poured down the inner walls of the sample bottle to minimize aeration of the sample.

2.2.3.3 Storm Sewer Sampling

A peristaltic pump with dedicated Teflon[®]-lined polyethylene tubing was used to extract ground water samples from the storm sewer. The sample was transferred directly to the appropriate sample container. The water was carefully poured down the inner walls of the sample bottle to minimize aeration of the sample.

2.2.4 Onsite Chemical Parameter Measurement

2.2.4.1 Dissolved Oxygen Measurements

DO measurements were taken using an Orion[®] model 840 DO meter. Groundwater was continuously extracted and collected in an erlenmeyer flask using a peristaltic pump. The probe of the DO meter was submerged in the erlenmeyer flask to monitor DO concentrations. DO concentrations were recorded after DO readings stabilized and these readings represent the lowest DO concentration observed.

2.2.4.2 Reduction/Oxidation Potential Measurements

Redox potential measurements were taken in a similar manner as DO measurements using an Orion[®] model 290A redox potential meter. Groundwater was continuously extracted with a peristaltic pump and collected in an erlenmeyer flask. The redox probe was submerged in the erlenmeyer flask to take continuous redox measurements. Redox potential measurements were recorded after the readings stabilized and these readings represent the lowest redox potential observed.

2.2.4.3 pH, Temperature, and Specific Conductance

Because the pH, temperature, and specific conductance of the ground water change significantly within a short time following sample acquisition, these parameters were measured in the field. The measurements were made in a clean glass container separate from those intended for laboratory analysis, and the measured values were recorded in the ground water sampling record.

2.2.5 Sample Handling

2.2.5.1 Sample Preservation

The USEPA Mobile Laboratory added any necessary chemical preservatives to sample containers prior to sampling. Soil samples collected for VOC analysis were stored in 40 milliliter (mL) volatile organic analysis (VOA) vials and preserved with 5 mL of acidified water (pH < 2) and 5 mL of methylene chloride. Soil samples collected for TOC measurements were stored at 4 degrees Celsius (°C) in coolers. Ground water samples collected for VOC analysis were stored in 40 mL VOA vials with lead lined septa and preserved with 4 grams of trisodium phosphate. Ground water samples for all oxidized inorganic compounds, with the exception of nitrate, were stored in 200 mL high density polyethylene (HDPE) sample containers and stored at 4°C or below. Ground water samples collected for nitrate analysis were stored in 200 mL HDPE sample containers and acidified (pH < 2) with sulfuric acid. All analysis for reduced inorganic species (e.g. ferrous iron, nitrite, and methane) were performed immediately in the field.

2.2.5.2 Sample Container and Labels

Sample containers and appropriate container lids were provided by the EPA Mobile Laboratory. The sample containers were filled as described in Sections 2.2.3.1.4, 2.2.3.2.4, and 2.2.3.3, and the container lids were tightly closed. Samples to be analyzed for VOCs were collected into containers with zero headspace. The sample label was firmly attached to the container side, and the following information was legibly and indelibly written on the label:

- Facility name;
- Sample identification;
- Sample type (ground water);
- Sampling date;
- Sampling time;
- Preservatives added; and,
- Sample collector's initials.

2.2.5.3 Sample Shipment

After the samples were sealed and labeled, they were packaged for immediate transport to the onsite USEPA Mobile Laboratory. The following packaging and labeling procedures were followed:

- Sample was packaged to prevent leakage or vaporization from its container;
- Shipping container was labeled with
 - Sample collector's name, address, and telephone number;
 - Laboratory's name, address, and telephone number;
 - Description of sample;
 - Quantity of sample; and
 - Date of transfer to onsite laboratory.

The packaged samples were delivered to the USEPA Mobile Laboratory. Delivery occurred shortly after sample acquisition.

2.3 AQUIFER TESTING

2.3.1 Slug Testing

Slug tests were conducted to estimate the hydraulic conductivity of the shallow saturated zone at UST Site 870. Slug tests are single-well hydraulic tests used to determine the hydraulic conductivity of an aquifer in the immediate vicinity of the tested well. Slug tests can be used for both confined and unconfined aquifers that have a transmissivity of less than 7,000 square feet per day (ft²/day). Slug testing can be performed using either a rising head or a falling head test. Rising head tests generally give more accurate results and were used at this site. Slug tests were performed in monitoring wells EPA 82-C, EPA 82-F, EPA 82-G, EPA 82-H, and EPA 82-I. Detailed slug testing procedures are presented in the *Draft Technical Protocol for Implementing the Intrinsic Remediation with Long-Term Monitoring Option for Natural Attenuation of Dissolved-Phase Fuel Contamination in Ground Water* (Wiedemeier *et al.*, 1994), hereafter referred to as the Technical Protocol document.

2.3.1 Slug Test Data Analysis

Data obtained during slug testing were analyzed using AQTESOLV software and the method of Bouwer and Rice (1976) and Bouwer (1989) for unconfined conditions. The results of slug testing are presented in Section 3.3.

2.4 SURVEYING

After completion of field work all new monitoring wells, soil boring locations, and those Geoprobe® sampling locations not located immediately adjacent to a CPT test location were surveyed by a State of Utah licensed professional land surveyor. Horizontal location was surveyed to the nearest 0.1 foot. Datum and ground surface elevations for were surveyed to the nearest 0.01 foot.

SECTION 3

PHYSICAL CHARACTERISTICS OF THE STUDY AREA

This section incorporates data collected during investigations as summarized by JMM (1993b) and MWI (1994a and 1994b), and more recent investigations conducted by Parsons ES in conjunction with researchers from the USEPA RSKERL in August 1993 and July 1994, to describe the physical characteristics of UST Site 870. The investigative techniques used by Parsons ES and RSKERL researchers to determine the physical characteristics of UST Site 870 are discussed in Section 2.

3.1 SURFACE FEATURES

3.1.1 Topography and Surface Water Hydrology

UST Site 870 is located on a plateau-like bench formed by the paleodelta of the ancient Weber River. This delta was formed as the Weber River deposited its sediment load when it entered ancient Lake Bonneville. Surface topography at the site slopes to the southwest (Figure 1.1). There are no naturally occurring surface water bodies in the immediate vicinity of UST Site 870. There are, however, several manmade features at or near the site that influence surface water runoff. These features are discussed in Section 3.1.2.

3.1.2 Manmade Features

Surface cover at UST Site 870 and adjacent areas consists of asphalt paving, grass, residential housing, concrete overlays, etc. Precipitation either infiltrates into the ground surface or is collected in gutters along the numerous roads in the Patriot Hills housing complex and diverted into several stormwater sewers in the Patriot Hills housing area. Figure 3.1 shows the locations of stormwater sewers in the area. One storm sewer, located along Cambridge Street, potentially intercepts ground water flow. There is a stormwater collection pond (Pond 5) located to the southwest of the Patriot Hills Housing Area (Figure 3.1).

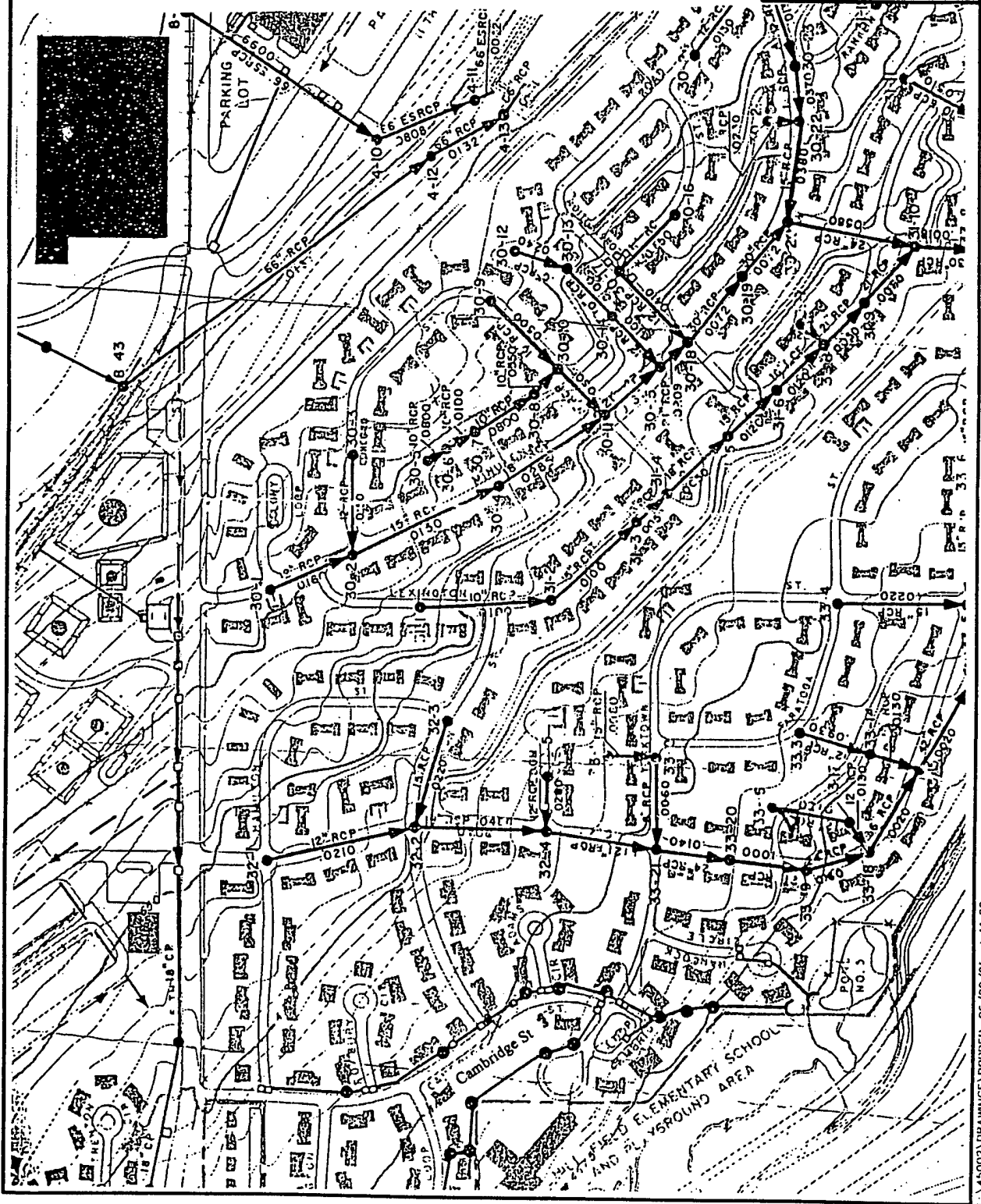

FIGURE 3.1
STORM SEWER LAYOUT
 UST Site 870
 Intrinsic Remediation EE/CA
 Hill Air Force Base, Utah
PARSONS ENGINEERING SCIENCE, INC.
 Denver, Colorado

3.2 REGIONAL GEOLOGY AND HYDROGEOLOGY

Three aquifers are present in the vicinity of UST Site 870. In order of increasing depth, these aquifers are the shallow aquifer, the Sunset Aquifer, and the Delta Aquifer. Hill AFB is located just west of the Wasatch Front in north-central Utah. Sediment comprising the shallow subsurface in the area consists of unconsolidated clay, silt, sand, and gravel which was eroded from the Wasatch Front and deposited as fluvial-deltaic basin-fill deposits where the ancient Weber River entered Lake Bonneville during Quaternary and Recent times (Feth *et al.*, 1966).

The shallow aquifer in the vicinity of UST Site 870 is the subject of this study and is discussed in detail in the following sections. Insufficient data are available for ground water in the Sunset Aquifer beneath UST Site 870 to allow an assessment of ground water quality. Total dissolved solids (TDS) values for the Delta Aquifer range from 156 to 354 milligrams per liter (mg/L) (JMM, 1993b). These TDS values, and the fact that no regulated contaminants have been detected in ground water of the Delta Aquifer, allow this aquifer to be classified as Class IA (Pristine Ground Water) under Utah Administrative Code (UAC) R448-6-3.

3.3 SITE GEOLOGY AND HYDROGEOLOGY

Characterization of the vadose zone and shallow aquifer system at UST Site 870 has been the objective of several site investigations. MWI (formerly JMM) installed 44 CPT test holes (some of which contain piezometers) and 14 ground water monitoring wells (MW prefix) at UST Site 870. Figure 1.2 shows the locations of these test holes and wells. During the week of 2 August 1993, Parsons ES, in conjunction with researchers from the USEPA RSKERL, collected 17 Geoprobe[®] ground water samples at 9 locations (shallow and deep testing) next to the CPT locations previously investigated by MWI. During the week of 16 August 1993, Parsons ES, in conjunction with researchers from the RSKERL, drilled eight soil borings in which ground water monitoring wells were installed. These soil boreholes/monitoring wells are designated EPA-82-A, EPA-82-B, EPA-82-C, EPA-82-D, EPA-82-E, EPA-82-F, EPA-82-H, and EPA-82-I (Sample location designation EPA 82-G was used for ground water samples collected from the stormwater drain running parallel to Cambridge Street). During the week of 4 July 1994, Parsons ES, in conjunction with researchers from the RSKERL, drilled two soil borings designated EPA-82-J and EPA-82-KK. A monitoring well, designated EPA-82-J was installed in soil boring EPA-82-J. No monitoring well was installed in soil boring EPA-82-KK. Table 2.1 presents available well and piezometer completion information.

3.3.1 Lithology and Stratigraphic Relationships

The shallow sediments underlying UST Site 870 and the Patriot Hills housing area are comprised of shallow, light reddish-brown to dark gray, cohesive clayey silts to silty clays. This clayey silt to silty clay interval ranges in thickness from approximately 4 feet to 15 feet and is abruptly underlain by poorly to moderately sorted, yellowish-brown to reddish-brown, silty fine-grained sands that coarsen downward into moderately sorted medium- to coarse-grained sands. These sands range in thickness from approximately 3 to 22 feet and the shallow saturated zone at the site occurs within these sands. Underlying the sands is a sequence of competent, thinly interbedded clay to silty clay and fine- to very-fine-grained clayey sand and silt of unknown thickness. This sequence of interbedded clay and fine-grained sand and silt appears to act as an effective barrier to the vertical migration of water and contaminants.

These stratigraphic relationships are illustrated by hydrogeologic sections A-A' and B-B'. Figure 3.2 shows the locations of these sections. Figure 3.3 presents hydrogeologic section A-A', which is oriented approximately parallel to the direction of ground water flow. Figure 3.4 presents hydrogeologic section B-B', which is oriented approximately perpendicular to the direction of ground water flow.

3.3.2 Grain Size Distribution

Grain size analyses were performed by JMM on soil samples from the soil borings completed as monitoring wells MW-5 (sample collected from approximately 31 feet bgs) and MW-6 (sample collected from approximately 31 feet bgs). Both samples are representative of the deep interbedded clay to silty clay and fine- to very-fine-grained clayey sand and silt described earlier. Seventy to 90 percent of the soils from both samples passed through the #200 US Standard Sieve. The #200 sieve size represents the break between fine sand and silt, and therefore these sediments are dominated by silt and clay.

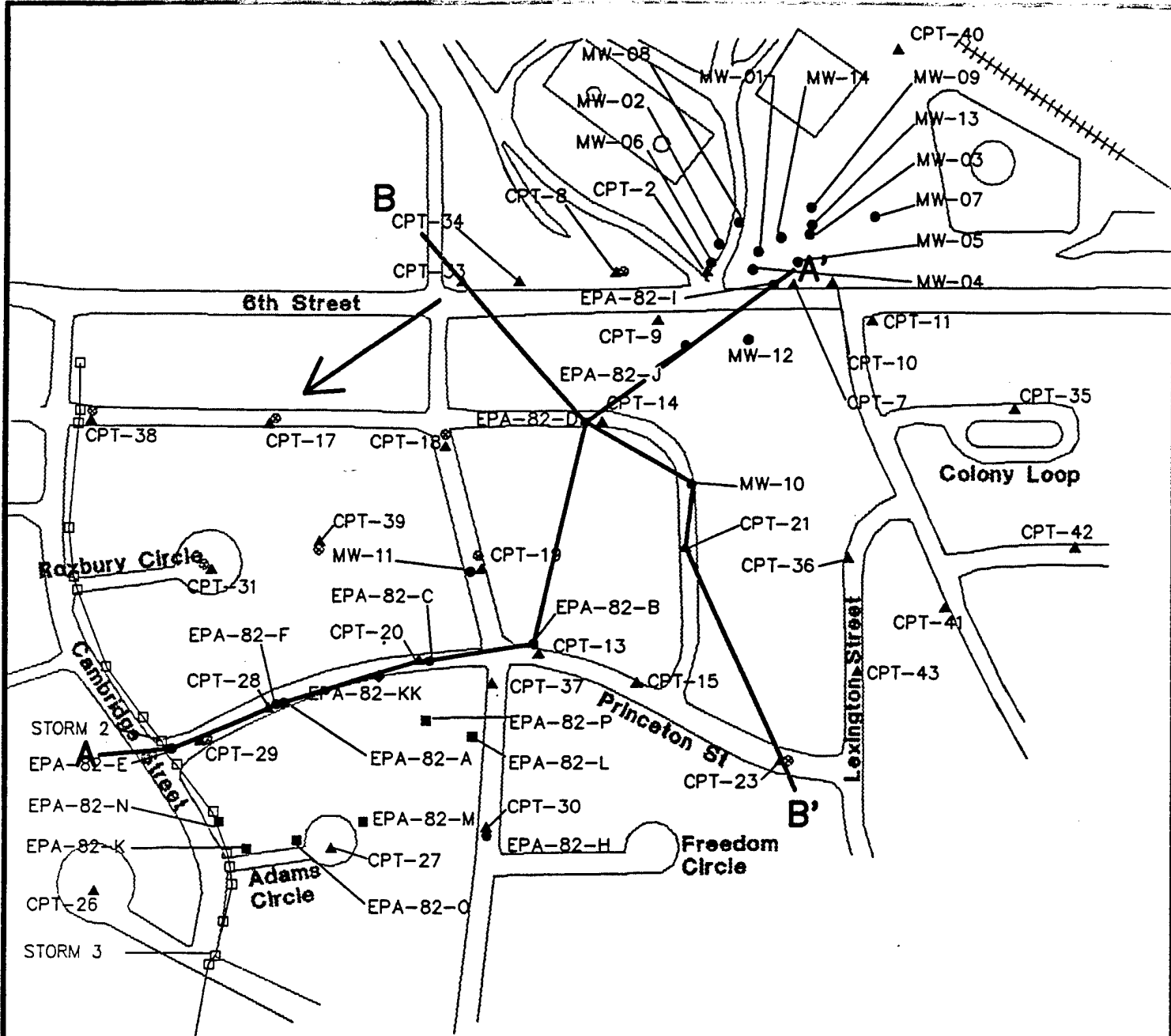

LEGEND

- CPT-26 ▲ CONE PENETROMETER TEST POINT/PIEZOMETER
- MW-11 ● MONITORING WELL LOCATION
- ⊙ AUGUST 1993 GEOPROBE SAMPLING LOCATION
- STORM DRAIN SURVEY LOCATION
- EPA-82-M JULY 1994 GEOPROBE SAMPLING
- EPA-82-KK ◆ JULY 1994 SOIL BORING LOCATION
- ↙ GROUND WATER FLOW DIRECTION
- A—A' LINE OF HYDROGEOLOGIC SECTION



FIGURE 3.2

HYDROGEOLOGIC SECTION LOCATION MAP

UST Site 870
 Intrinsic Remediation EE/CA
 Hill Air Force Base, Utah

PARSONS ENGINEERING SCIENCE, INC.
 Denver, Colorado

SW A A' NE

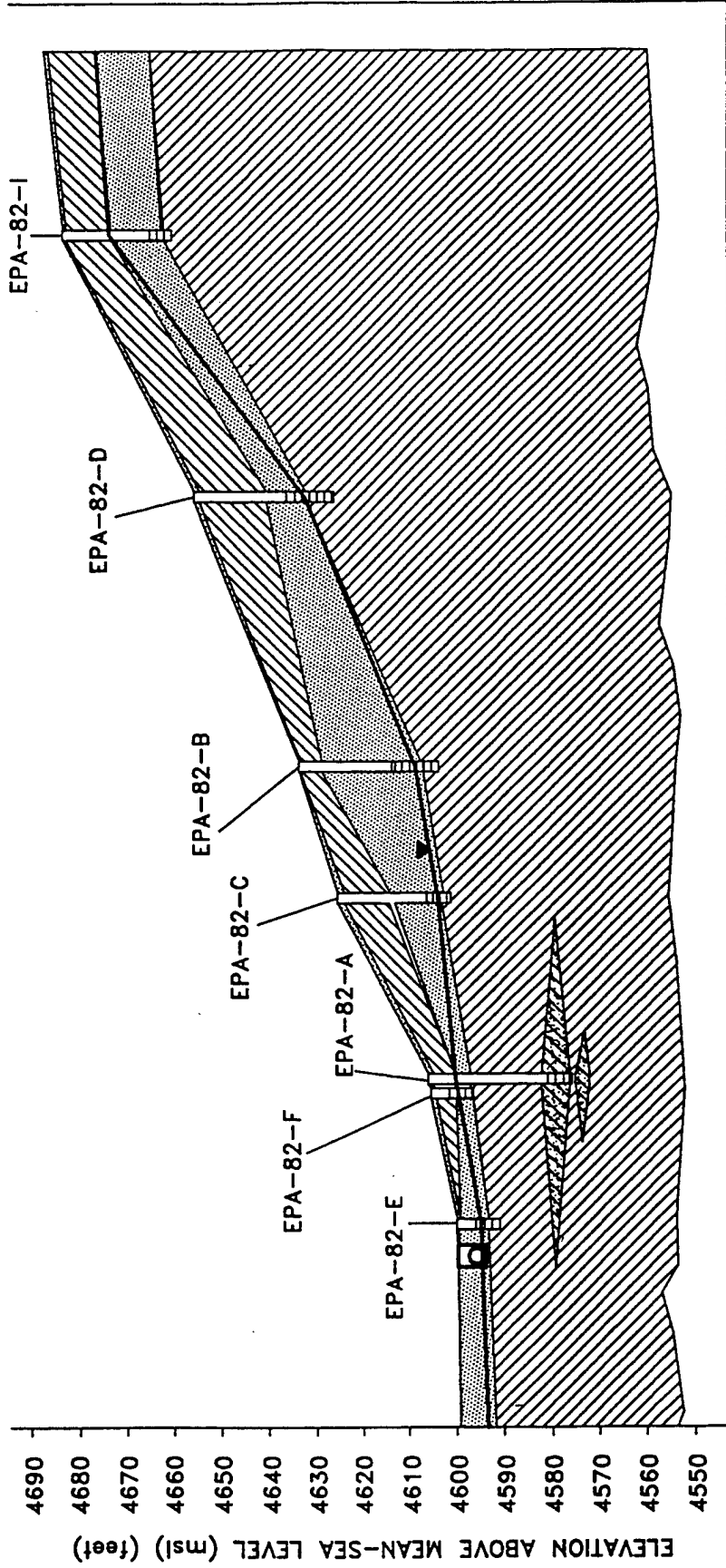

LEGEND

- Poorly to Moderately Sorted Sands
- Clayey and Silty Sand
- Silty and Clayey Sand
- Clayey Silt and Silty Clay
- Storm Sewer
- Ground Water Level (August 1993)



FIGURE 3.3

HYDROGEOLOGIC SECTION A-A'

UST Site 870
 Intrinsic Remediation EE/CA
 Hill Air Force Base, Utah

PARSONS ENGINEERING SCIENCE, INC.
 Denver, Colorado

NW
B
CPT-33*

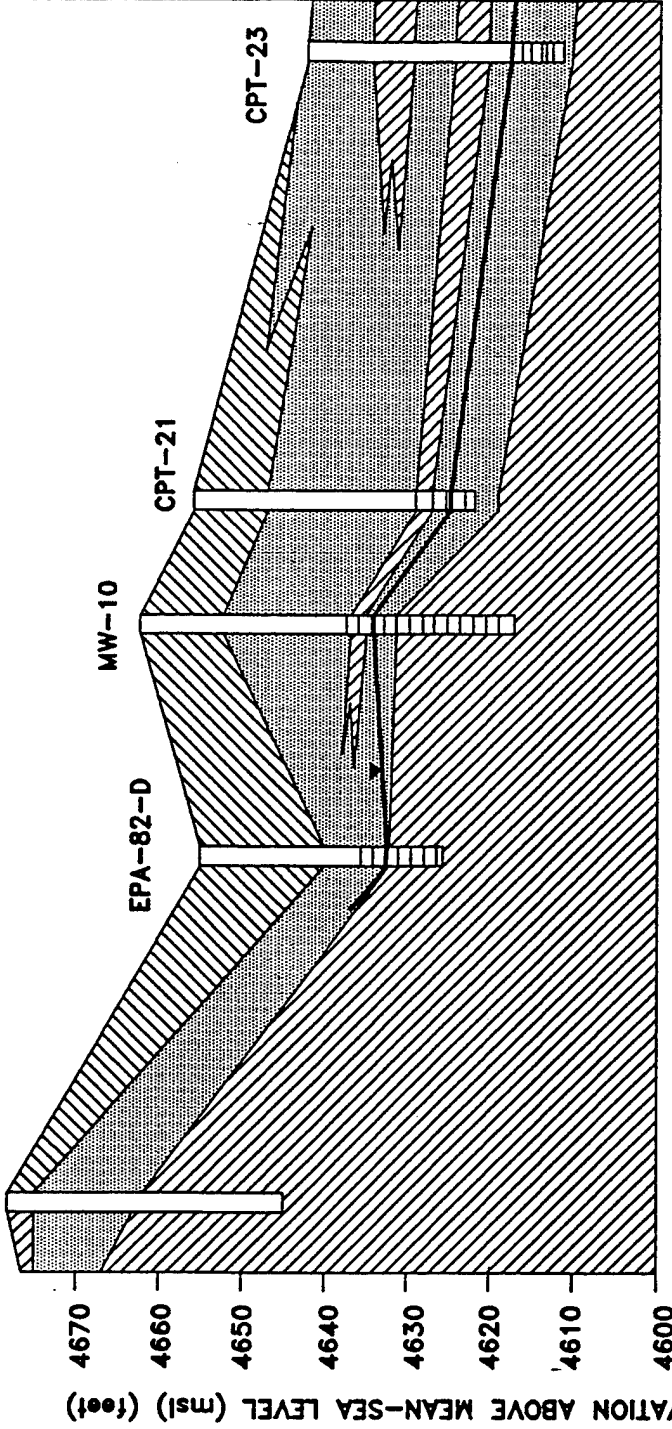

LEGEND

□ Poorly to Moderately Sorted Sands

▨ Clayey and Silty Silt

— Ground Water Level (August 1993)

□ No Water Level Data

▨ Clayey Silt and Silty Clay



VERTICAL EXAGGERATION = 10 TIMES

FIGURE 3.4

HYDROGEOLOGIC SECTION B-B'

UST Site 870
Intrinsic Remediation EE/CA
Hill Air Force Base, Utah



PARSONS ENGINEERING SCIENCE, INC.

Denver, Colorado

3.3.3 Ground Water Hydraulics

3.3.3.1 Flow Direction and Gradient

Ground water flow in the vicinity of UST Site 870 is to the southwest, with an average gradient of approximately 0.048 foot per foot (ft/ft) between wells EPA-82-I and CPT-27 (Figure 3.5). Available ground water elevation data are presented in Appendix B. Ground water flow appears to be limited to a relatively thin zone in the medium- to coarse-grained sands located immediately above the lower thinly interbedded clay to silty clay and fine- to very-fine-grained clayey sand and silt horizon (Figures 3.3 and 3.4). Available site data show that there is almost no seasonal variation in ground water flow direction or gradient at the site (Appendix B and MWI, 1994b).

3.3.3.2 Hydraulic Conductivity (K)

Hydraulic conductivity in the medium- to coarse-grained sands of the shallow saturated zone was estimated using rising head slug tests as described in Section 2. Slug tests were performed in monitoring wells EPA-82-A, EPA-82-E, EPA-82-F, EPA-82-H, and EPA-82-I. The results of these slug tests are summarized in Table 3.1. The average hydraulic conductivity for the shallow saturated zone as determined from these tests is 0.0159 foot per minute or 0.0085 centimeter per second (cm/sec). Appendix A contains slug test results. In addition, JMM (1991) performed two slug tests in monitoring well MW-01. The hydraulic conductivity as determined from these tests ranged from 0.00015 to 0.00018 cm/sec.

The average hydraulic conductivity estimated by Parsons ES for the shallow saturated zone is one to two orders of magnitude higher than hydraulic conductivities estimated by JMM (1993b). As illustrated in available borelogs for both Parsons ES and JMM, the heterogeneous site stratigraphy is composed of numerous soil types including moderately sorted, silty fine- to medium-grained sand, medium- to coarse-grained sands, cohesive clayey silts to silty clays, silty clay, and clayey sand. Slug tests performed by JMM at MW-1 were influenced by silty sands with a large interval (~4 ft) of clayey sand over the screened interval of the well. The locations selected by Parsons ES for slug testing (EPA installed wells) were characterized by predominately fine- to medium-grained sands over the well screen intervals; thus, higher values of hydraulic conductivity were derived because slug tests were conducted in more transmissive soils.

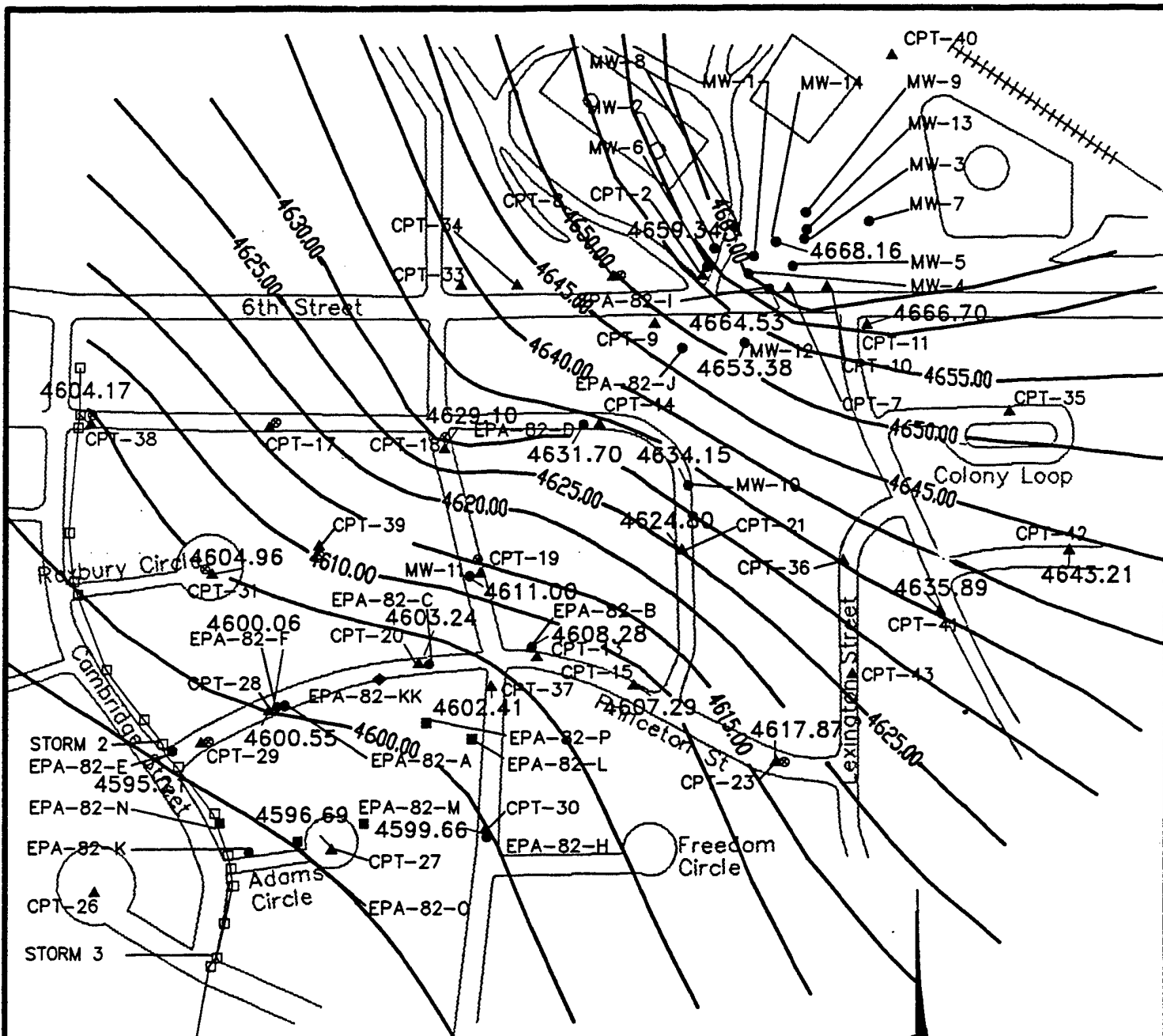

LEGEND

- CPT-26 ▲ CONE PENETROMETER TEST POINT/
PIEZOMETER
- MW-11 ● MONITORING WELL LOCATION
- AUGUST 1993 GEOPROBE SAMPLING
LOCATION
- STORM DRAIN SURVEY LOCATION
- EPA-82-M ■ JULY 1994 GEOPROBE SAMPLING
LOCATION
- EPA-82-KK ◆ JULY 1994 SOIL BORING LOCATION
- 4580 — LINE OF EQUAL GROUND WATER
ELEVATION (FEET ABOVE MSL)



FIGURE 3.5

**GROUNDWATER ELEVATION MAP
JULY-AUGUST 1993**

UST Site 870
Intrinsic Remediation EE/CA
Hill Air Force Base, Utah

**PARSONS
ENGINEERING SCIENCE, INC.**

Denver, Colorado

TABLE 3.1
SLUG TEST RESULTS
UST SITE 870 INTRINSIC REMEDIATION EE/CA
HILL AFB, UTAH

WELL	TEST	HYDRAULIC CONDUCTIVITY (feet/sec)	HYDRAULIC CONDUCTIVITY (cm/sec)
EPA 82-A	Rising Head #1	1.19E-05	3.63E-04
EPA-82-E	Rising Head #1	5.50E-04	1.67E-02
EPA-82-E	Rising Head #2	6.08E-04	1.85E-02
EPA-82-F	Rising Head #1	1.36E-04	4.13E-03
EPA-82-F	Rising Head #2	1.08E-04	3.28E-03
EPA-82-H	Rising Head #2	2.48E-04	7.56E-03
EPA-82-H	Rising Head #3	2.73E-04	8.31E-03
EPA-82-I	Rising Head #1	1.57E-04	4.77E-03
EPA-82-I	Rising Head #2	3.58E-05	1.09E-03
	AVERAGE*	2.65E-04	8.05E-03

* Average of wells EPA-82-E, EPA-82-F, EPA-82-H, and EPA-82-I.

Well EPA-82-A completed in a sandy unit found within the deep silty clay

3.3.3.3 Effective Porosity (n_e)

Because of the difficulty involved in accurately determining effective porosity, accepted literature values for the type of soil comprising the shallow saturated zone were used. Freeze and Cherry (1979) give a range of effective porosity for sand of 0.25 to 0.50. To be conservative (lower effective porosity results in greater ground water velocity), the effective porosity for sediments of the shallow saturated zone is assumed to be 0.25.

3.3.3.4 Advective Ground Water Velocity (\bar{v})

The advective velocity of ground water in the direction parallel to ground water flow is given by:

$$\bar{v} = \frac{-K}{n_e} \frac{dH}{dL}$$

Where: \bar{v} = Average advective ground water velocity (seepage velocity) [L/T]

K = Hydraulic conductivity [L/T] (2.65×10^{-4} ft/sec)

dH/dL = Gradient [L/L] (0.048 ft/ft)

n_e = Effective porosity (0.25).

Using this relationship in conjunction with site-specific data, the average advective ground water velocity at the site is 4.4 feet per day (ft/day) or approximately 1,600 feet/year.

3.3.3.5 Preferential Flow Paths

Two preferential contaminant migration pathways were identified during the field work phase of this project. The first is a utility corridor on the north side of Sixth Street. This utility corridor runs parallel to Sixth Street. The influence of this corridor on contaminant migration has not been directly investigated but its influence on ground water flow is unlikely because of its relatively shallow depth.

The second potential preferential contaminant migration pathway is a storm sewer that intersects ground water flow in at least a portion of the site near Cambridge Street. This storm sewer is located along Cambridge Street (Figure 3.1). During field work conducted by Parsons ES and RSKERL personnel in August 1993, ground water appeared to be flowing in this storm sewer near the intersection of Cambridge and Princeton streets. The possibility that this water was ground water was supported by ground water elevation data and surveyor's data collected at several points along the storm sewer (e.g., culvert invert elevation data, see Figure 3.3). To determine if contaminated ground water was being intercepted by this storm sewer, two water samples, storm-2 and storm-3, were collected at the locations shown in Figure 1.2. The analytical results for these samples indicated that no ground water contamination was being intercepted by the storm drain in August 1993.

3.3.5 Ground Water Use

Ground water from the surficial aquifer at Hill AFB is not extracted for potable uses. Water is obtained from on-base deep supply wells in the months of October through April. Water is supplied by a combination of deep supply wells and water piped in from the nearby Weber Basin Water Conservancy District during the remainder of the year.

3.4 CLIMATOLOGICAL CHARACTERISTICS

Regional climatological characteristics for the site were obtained from an AWS Climatic Brief. Meteorology at the site is impacted by the Wasatch Range located west of the site. This range is oriented north-south and rises over 5,000 vertical feet above the valley floor in less than 5 miles, causing an abrupt barrier for Pacific frontal systems moving into northern Utah. This barrier, coupled with moisture from the Great Salt Lake, causes fronts to build up over Hill AFB, resulting in low cloud ceilings and prolonged periods of precipitation.

Monthly mean high temperatures range from about 27 °F in January to about 76 °F in July. Recorded extreme high and low temperatures for the period from 1941 to 1984 were 104 °F and -13 °F, respectively. Mean annual precipitation for this same period is 20.1 inches.

SECTION 4

NATURE AND EXTENT OF CONTAMINATION AND SOIL AND GROUND WATER GEOCHEMISTRY

4.1 SOURCE OF CONTAMINATION

The source of contamination at UST Site 870 is not known with any degree of certainty, nor is it known how much fuel leaked into the subsurface. About 700 gallons of LNAPL have been recovered by product recovery systems since their installation in June 1992. Former UST 870.0 may have contributed to the contamination observed at the site, but it is unlikely that leakage from this UST was responsible for all of the contamination. This UST was used to store condensate and residual JP-4 generated by operations at a nearby filter stand. Following the removal of UST 870.0, a new tank equipped with leak-detection equipment was installed in the same excavation. Based on the large quantity of contamination, other potential sources of contamination include: leaky piping associated with the UST, surface spills and releases from operations since the 1940s, and a faulty 6-inch diameter pipe located behind the pump facility Building 870 (pending repairs).

4.2 SOIL CHEMISTRY

4.2.1 Mobile LNAPL Contamination

Mobile LNAPL is defined as the LNAPL that is free to flow in the aquifer and that will flow from the aquifer matrix into a well under the influence of gravity. Mobile LNAPL is present in several monitoring wells and piezometers at the site (Appendix B). Figure 4.1 is an isopach map showing the distribution and measured thickness of mobile LNAPL at the site in July and August 1993. This map was prepared using the greatest mobile LNAPL thickness measured at each location during this period. The LNAPL plume appears to be comprised of weathered JP-4 that emanates from the aboveground storage tank facility. Figure 4.1 suggests that the LNAPL plume extended approximately 750 feet downgradient from the source area in July/August 1993. The areal extent of suspected mobile LNAPL contamination is approximately 225,000 square

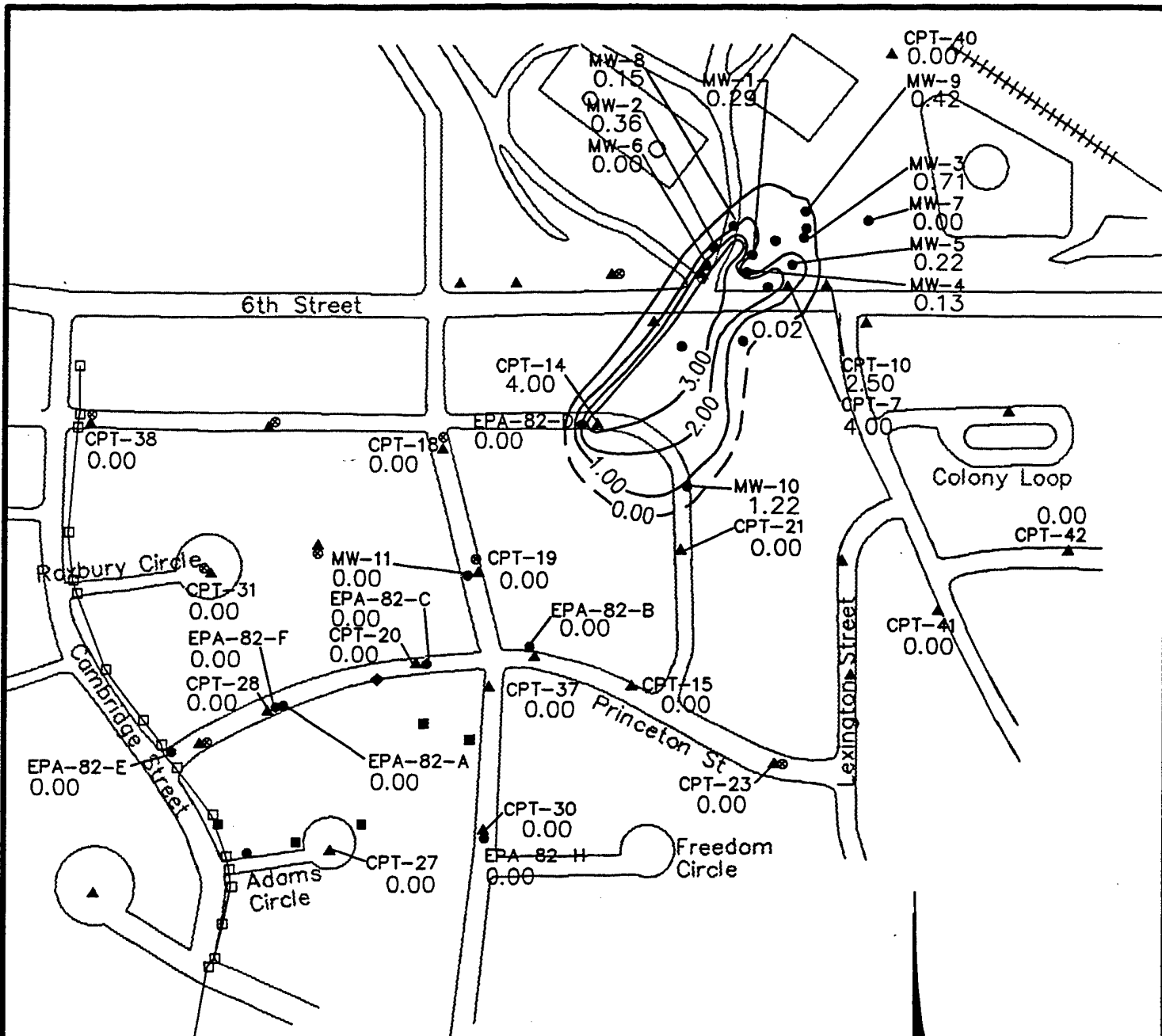

LEGEND

- CPT-26 ▲ CONE PENETROMETER TEST POINT/
PIEZOMETER
- MW-11 ● MONITORING WELL LOCATION
- AUGUST 1993 GEOPROBE SAMPLING
LOCATION
- STORM DRAIN SURVEY LOCATION
- EPA-82-M ■ JULY 1994 GEOPROBE SAMPLING
LOCATION
- EPA-82-KK ◆ JULY 1994 SOIL BORING LOCATION
- 1.00 — LINE OF EQUAL LNAPL
THICKNESS (FEET)
(GREATEST THICKNESS FOR JULY/
AUGUST 1993)

CONTOUR INTERVAL = 1 FOOT



FIGURE 4.1
LNAPL
ISOPACH MAP
JULY/AUGUST 1993

UST Site 870
Intrinsic Remediation EE/CA
Hill Air Force Base, Utah

PARSONS
ENGINEERING SCIENCE, INC.
Denver, Colorado

feet. Concentrations of BTEX and trimethylbenzene (TMB) constituents in the mobile LNAPL were quantitated using a sample of LNAPL collected from MW-10 in August 1993. Concentrations of BTEX and TMBs in this sample indicate that the JP-4 comprising the LNAPL plume in this area is significantly weathered. Table 4.1 compares BTEX concentrations in fresh JP-4 to those observed in LNAPL from MW-10. Toluene and benzene concentrations are reduced by 1 to 3 orders of magnitude, respectively, and ethylbenzene and total xylene concentrations are reduced by about one-half.

TABLE 4.1
COMPARATIVE FRESH AND WEATHERED
LNAPL BTEX ANALYTICAL RESULTS
UST SITE 870 INTRINSIC REMEDIATION EE/CA
HILL AFB, UTAH

Contaminant	Concentration in Fresh JP-4 (mg/L)	Concentration in Weathered JP-4 from MW-10 (August, 1993) (mg/L)
Benzene	3750	1
Toluene	9975	134
Ethylbenzene	2775	1020
<i>o</i> -xylene	7575	2380
<i>m</i> -xylene	7200	5500
<i>p</i> -xylene	2625	1070

The relationship between measured LNAPL thickness and the amount of mobile LNAPL in the subsurface at a site is extremely difficult to quantify. Based on soil core data and measured LNAPL thicknesses, there appears to be a significant difference between measured LNAPL thickness and the actual thickness of mobile LNAPL present at the site. It is well documented that LNAPL thickness measurements taken in ground water monitoring wells are not indicative of actual mobile LNAPL thicknesses in the formation (Kemblowski and Chiang, 1990; Concawe, 1979; Abdul *et al.*, 1989; Testa and Paczkowski, 1989; Hughes *et al.*, 1988; Blake and Hall, 1984; Hall *et al.*, 1984; Hampton and Miller, 1988; Mercer and Cohen, 1990; de Pastrovich *et al.*,

1979; Lehnard and Parker, 1990; Ballesterio, *et al.*, 1994). It has been noted by these authors that the thickness of LNAPL measured in a monitoring well is greater than the actual mobile LNAPL thickness present in the aquifer and, according to Mercer and Cohen (1990), measured LNAPL thickness in wells is typically 2 to 10 times greater than the actual mobile LNAPL thickness in the formation.

4.2.2 Residual-Phase (Stationary) LNAPL Contamination

Residual-phase LNAPL is defined as the LNAPL that is trapped in the aquifer by the processes of cohesion and capillarity and therefore will not flow within the aquifer and will not flow from the aquifer matrix into a well under the influence of gravity. The following sections describe the residual-phase LNAPL contamination found at UST Site 870.

4.2.2.1 Soil BTEX Contamination

Residual-phase BTEX contamination resulting from vertically and laterally migrating LNAPL is found over a wide area at UST Site 870. Table 4.2 contains soil BTEX and TPH data. Figure 4.2 is an isopleth map showing maximum observed total BTEX concentrations in soil at UST Site 870. Soil BTEX contamination appears to extend approximately 1,600 feet downgradient from the source area and is approximately 500 feet wide at the widest point. The highest observed concentration of residual-phase BTEX is 554 mg/kg in a soil core sample taken from approximately 18 feet bgs in soil boring EPA-82-I, which is in the suspected source area of JP-4 contamination. This corresponds with the highest measured TPH concentration of 28,300 mg/kg. Measured total BTEX concentrations decrease rapidly in areas devoid of mobile-phase LNAPL contamination, and the majority of the area shown in Figure 4.2 is characterized by total BTEX concentrations of less than 50 mg/kg.

4.2.2.2 Soil TPH Contamination

Figure 4.3 is an isopleth map showing TPH concentrations in soil. This figure shows that elevated TPH concentrations are widespread at the site. TPH levels exceed 28,000 mg/kg at EPA-82-I. TPH contamination appears to extend downgradient from the source area for approximately 1,600 feet with an approximate width of 450 feet. The vertical thickness of TPH

TABLE 4.2
 FUEL HYDROCARBON COMPOUNDS DETECTED IN SOIL
 UST SITE 870 INTRINSIC REMEDIATION EE/CA
 HILL AFB, UTAH

Sample Location*	Sample Date	Sample Interval Top (ft bgs)	Sample Interval Bottom (ft bgs)	Benzene (mg/kg)	Toluene (mg/kg)	Ethylbenzene (mg/kg)	P-Xylene (mg/kg)	M-Xylene (mg/kg)	M&P-Xylene (mg/kg)	O-Xylene (mg/kg)	Total Xylenes (mg/kg)	Total BTEX (mg/kg)	1,3,5-TMB (mg/kg)	1,2,4-TMB (mg/kg)	1,2,3-TMB (mg/kg)	TPH (mg/kg)
82 A-16	8/17/93	18.75	19.00	<0.01	<0.01	<0.01	<0.01	<0.01	NA	<0.01	<0.01	<0.01	<0.01	<0.01	<0.01	NA
82 A-15	8/17/93	19.00	19.25	<0.01	<0.01	<0.01	<0.01	<0.01	NA	<0.01	<0.01	<0.01	<0.01	<0.01	<0.01	NA
82 A-14	8/17/93	19.25	19.50	<0.01	<0.01	<0.01	<0.01	<0.01	NA	<0.01	<0.01	<0.01	<0.01	<0.01	<0.01	NA
82 A-13	8/17/93	19.50	19.75	<0.01	<0.01	<0.01	<0.01	<0.01	NA	<0.01	<0.01	<0.01	<0.01	<0.01	<0.01	NA
82 A-12	8/17/93	19.75	20.00	<0.01	<0.01	<0.01	<0.01	<0.01	NA	<0.01	<0.01	<0.01	<0.01	<0.01	<0.01	NA
82 A-11	8/17/93	20.00	20.25	<0.01	<0.01	<0.01	<0.01	<0.01	NA	<0.01	<0.01	<0.01	<0.01	<0.01	<0.01	NA
82 A-10	8/17/93	20.25	20.50	<0.01	<0.01	<0.01	<0.01	<0.01	NA	<0.01	<0.01	<0.01	<0.01	<0.01	<0.01	NA
82 A-09	8/17/93	20.50	20.75	<0.01	<0.01	<0.01	<0.01	<0.01	NA	<0.01	<0.01	<0.01	<0.01	<0.01	<0.01	NA
82 A-08	8/17/93	20.75	21.00	<0.01	<0.01	<0.01	<0.01	<0.01	NA	<0.01	<0.01	<0.01	<0.01	<0.01	<0.01	NA
82 A-07	8/17/93	21.00	21.25	<0.01	<0.01	<0.01	<0.01	<0.01	NA	<0.01	<0.01	<0.01	<0.01	<0.01	<0.01	NA
82 A-06	8/17/93	21.25	21.50	<0.01	<0.01	<0.01	<0.01	<0.01	NA	<0.01	<0.01	<0.01	<0.01	<0.01	<0.01	NA
82 A-05	8/17/93	21.50	21.75	<0.01	<0.01	<0.01	<0.01	<0.01	NA	<0.01	<0.01	<0.01	<0.01	<0.01	<0.01	NA
82 A-04	8/17/93	21.75	22.00	<0.01	<0.01	<0.01	<0.01	<0.01	NA	<0.01	<0.01	<0.01	<0.01	<0.01	<0.01	NA
82 A-03	8/17/93	22.00	22.25	<0.01	<0.01	<0.01	<0.01	<0.01	NA	<0.01	<0.01	<0.01	<0.01	<0.01	<0.01	NA
82 A-02	8/17/93	22.25	22.50	<0.01	<0.01	<0.01	<0.01	<0.01	NA	<0.01	<0.01	<0.01	<0.01	<0.01	<0.01	NA
82 A-01	8/17/93	22.50	22.75	<0.01	<0.01	<0.01	<0.01	<0.01	NA	<0.01	<0.01	<0.01	<0.01	<0.01	<0.01	NA
82 A-25	8/17/93	22.75	23.00	<0.01	<0.01	<0.01	<0.01	<0.01	NA	<0.01	<0.01	<0.01	<0.01	<0.01	<0.01	NA
82 A-24	8/17/93	23.00	23.40	<0.01	<0.01	<0.01	<0.01	<0.01	NA	<0.01	<0.01	<0.01	<0.01	<0.01	<0.01	NA
82 A-23	8/17/93	23.40	23.80	<0.01	<0.01	<0.01	<0.01	<0.01	NA	<0.01	<0.01	<0.01	<0.01	<0.01	<0.01	NA
82 A-22	8/17/93	23.80	24.20	<0.01	<0.01	<0.01	<0.01	<0.01	NA	<0.01	<0.01	<0.01	<0.01	<0.01	<0.01	NA
82 A-21	8/17/93	24.20	24.60	<0.01	<0.01	<0.01	<0.01	<0.01	NA	<0.01	<0.01	<0.01	<0.01	<0.01	<0.01	NA
82 A-20	8/17/93	24.60	25.00	<0.01	<0.01	<0.01	<0.01	<0.01	NA	<0.01	<0.01	<0.01	<0.01	<0.01	<0.01	NA
82 A-19	8/17/93	25.00	25.40	<0.01	<0.01	<0.01	<0.01	<0.01	NA	<0.01	<0.01	<0.01	<0.01	<0.01	<0.01	NA
82 A-18	8/17/93	25.40	25.80	<0.01	<0.01	<0.01	<0.01	<0.01	NA	<0.01	<0.01	<0.01	<0.01	<0.01	<0.01	NA
82 A-17	8/17/93	25.80	26.20	<0.01	<0.01	<0.01	<0.01	<0.01	NA	<0.01	<0.01	<0.01	<0.01	<0.01	<0.01	NA
82 A-41	8/17/93	27.00	27.30	<0.01	<0.01	<0.01	<0.01	<0.01	NA	<0.01	<0.01	<0.01	<0.01	<0.01	<0.01	NA
82 A-40	8/17/93	27.30	27.60	<0.01	<0.01	<0.01	<0.01	<0.01	NA	<0.01	<0.01	<0.01	<0.01	<0.01	<0.01	NA
82 A-39	8/17/93	27.60	27.90	<0.01	<0.01	<0.01	<0.01	<0.01	NA	<0.01	<0.01	<0.01	<0.01	<0.01	<0.01	NA
82 A-38	8/17/93	27.90	28.20	<0.01	<0.01	<0.01	<0.01	<0.01	NA	<0.01	<0.01	<0.01	<0.01	<0.01	<0.01	NA
82 A-37	8/17/93	28.20	28.50	<0.01	<0.01	<0.01	<0.01	<0.01	NA	<0.01	<0.01	<0.01	<0.01	<0.01	<0.01	NA
82 A-36	8/17/93	28.50	28.80	<0.01	<0.01	<0.01	<0.01	<0.01	NA	<0.01	<0.01	<0.01	<0.01	<0.01	<0.01	NA
82 A-35	8/17/93	28.80	29.10	<0.01	<0.01	<0.01	<0.01	<0.01	NA	<0.01	<0.01	<0.01	<0.01	<0.01	<0.01	NA
82 A-34	8/17/93	29.10	29.40	<0.01	<0.01	<0.01	<0.01	<0.01	NA	<0.01	<0.01	<0.01	<0.01	<0.01	<0.01	NA
82 A-33	8/17/93	29.40	29.70	<0.01	<0.01	<0.01	<0.01	<0.01	NA	<0.01	<0.01	<0.01	<0.01	<0.01	<0.01	NA
82 A-32	8/17/93	29.70	30.00	<0.01	<0.01	<0.01	<0.01	<0.01	NA	<0.01	<0.01	<0.01	<0.01	<0.01	<0.01	NA
82 A-31	8/17/93	30.00	30.30	<0.01	<0.01	<0.01	<0.01	<0.01	NA	<0.01	<0.01	<0.01	<0.01	<0.01	<0.01	NA
82 A-30	8/17/93	30.30	30.60	<0.01	<0.01	<0.01	<0.01	<0.01	NA	<0.01	<0.01	<0.01	<0.01	<0.01	<0.01	NA
82 A-29	8/17/93	30.60	30.90	<0.01	<0.01	<0.01	<0.01	<0.01	NA	<0.01	<0.01	<0.01	<0.01	<0.01	<0.01	NA

TABLE 4.2 (Continued)
 FUEL HYDROCARBON COMPOUNDS DETECTED IN SOIL
 UST SITE 870 INTRINSIC REMEDIATION EE/CA
 HILL AFB, UTAH

Sample Location	Sample Date	Sample Interval Top (ft bgs) Bottom (ft bgs)	Benzene (mg/kg)	Toluene (mg/kg)	Ethylbenzene (mg/kg)	P-Xylene (mg/kg)	M-Xylene (mg/kg)	M&P- Xylene (mg/kg)	O-Xylene (mg/kg)	Total Xylenes (mg/kg)	Total BTEX (mg/kg)	1,3,5- TMB (mg/kg)	1,2,4- TMB (mg/kg)	1,2,3- TMB (mg/kg)	TPH (mg/kg)
82 A-28	8/17/93	30.90 31.20	<0.01	<0.01	<0.01	<0.01	<0.01	NA	<0.01	<0.01	<0.01	<0.01	<0.01	<0.01	NA
82 A-27	8/17/93	31.50 31.80	<0.01	<0.01	<0.01	<0.01	<0.01	NA	<0.01	<0.01	<0.01	<0.01	<0.01	<0.01	NA
82 A-54	8/17/93	31.50 31.80	<0.01	<0.01	<0.01	<0.01	<0.01	NA	<0.01	<0.01	<0.01	<0.01	<0.01	<0.01	NA
82 A-53	8/17/93	31.80 32.10	<0.01	<0.01	<0.01	<0.01	<0.01	NA	<0.01	<0.01	<0.01	<0.01	<0.01	<0.01	NA
82 A-52	8/17/93	32.10 32.40	<0.01	<0.01	<0.01	<0.01	<0.01	NA	<0.01	<0.01	<0.01	<0.01	<0.01	<0.01	NA
82 A-51	8/17/93	32.40 32.70	<0.01	<0.01	<0.01	<0.01	<0.01	NA	<0.01	<0.01	<0.01	<0.01	<0.01	<0.01	NA
82 A-50	8/17/93	32.70 33.00	<0.01	<0.01	<0.01	<0.01	<0.01	NA	<0.01	<0.01	<0.01	<0.01	<0.01	<0.01	NA
82 A-49	8/17/93	33.00 33.30	<0.01	<0.01	<0.01	<0.01	<0.01	NA	<0.01	<0.01	<0.01	<0.01	<0.01	<0.01	NA
82 A-48	8/17/93	33.30 33.60	<0.01	<0.01	<0.01	<0.01	<0.01	NA	<0.01	<0.01	<0.01	<0.01	<0.01	<0.01	NA
82 A-47	8/17/93	33.60 33.90	<0.01	<0.01	<0.01	<0.01	<0.01	NA	<0.01	<0.01	<0.01	<0.01	<0.01	<0.01	NA
82 A-46	8/17/93	33.90 34.20	<0.01	<0.01	<0.01	<0.01	<0.01	NA	<0.01	<0.01	<0.01	<0.01	<0.01	<0.01	NA
82 A-45	8/17/93	34.20 34.50	<0.01	<0.01	<0.01	<0.01	<0.01	NA	<0.01	<0.01	<0.01	<0.01	<0.01	<0.01	NA
82 A-44	8/17/93	34.50 34.80	<0.01	<0.01	<0.01	<0.01	<0.01	NA	<0.01	<0.01	<0.01	<0.01	<0.01	<0.01	NA
82 A-43	8/17/93	34.80 35.10	<0.01	<0.01	<0.01	<0.01	<0.01	NA	<0.01	<0.01	<0.01	<0.01	<0.01	<0.01	NA
82 A-42	8/17/93	35.10 35.40	<0.01	<0.01	<0.01	<0.01	<0.01	NA	<0.01	<0.01	<0.01	<0.01	<0.01	<0.01	NA
82 B-12	8/18/93	20.00 20.30	<0.01	<0.01	<0.01	<0.01	<0.01	NA	<0.01	<0.01	<0.01	<0.01	<0.01	<0.01	NA
82 B-11	8/18/93	20.30 20.60	<0.01	<0.01	<0.01	<0.01	<0.01	NA	<0.01	<0.01	<0.01	<0.01	<0.01	<0.01	NA
82 B-10	8/18/93	20.60 20.90	<0.01	<0.01	<0.01	<0.01	<0.01	NA	<0.01	<0.01	<0.01	<0.01	<0.01	<0.01	NA
82 B-09	8/18/93	20.90 21.20	<0.01	<0.01	<0.01	<0.01	<0.01	NA	<0.01	<0.01	<0.01	<0.01	<0.01	<0.01	NA
82 B-08	8/18/93	21.20 21.50	<0.01	<0.01	<0.01	<0.01	<0.01	NA	<0.01	<0.01	<0.01	<0.01	<0.01	<0.01	NA
82 B-07	8/18/93	21.50 21.80	<0.01	<0.01	<0.01	<0.01	<0.01	NA	<0.01	<0.01	<0.01	<0.01	<0.01	<0.01	NA
82 B-06	8/18/93	21.80 22.10	<0.01	<0.01	<0.01	<0.01	<0.01	NA	<0.01	<0.01	<0.01	<0.01	<0.01	<0.01	NA
82 B-05	8/18/93	22.10 22.40	<0.01	<0.01	<0.01	<0.01	<0.01	NA	<0.01	<0.01	<0.01	<0.01	<0.01	<0.01	NA
82 B-04	8/18/93	22.40 22.70	<0.01	<0.01	<0.01	<0.01	<0.01	NA	<0.01	<0.01	<0.01	<0.01	<0.01	<0.01	NA
82 B-02	8/18/93	22.70 23.00	<0.01	<0.01	<0.01	<0.01	<0.01	NA	<0.01	<0.01	<0.01	<0.01	<0.01	<0.01	NA
82 B-01	8/18/93	23.00 23.30	<0.01	<0.01	<0.01	<0.01	<0.01	NA	<0.01	<0.01	<0.01	<0.01	<0.01	<0.01	NA
NSN	8/18/93	23.30 23.60	<0.01	<0.01	<0.01	<0.01	<0.01	NA	<0.01	<0.01	<0.01	<0.01	<0.01	<0.01	NA
NSN	8/18/93	23.60 23.90	<0.01	<0.01	<0.01	<0.01	<0.01	NA	<0.01	<0.01	<0.01	<0.01	<0.01	<0.01	NA
82 B-24	8/18/93	23.90 24.10	<0.01	<0.01	<0.01	<0.01	<0.01	NA	<0.01	<0.01	<0.01	<0.01	<0.01	<0.01	NA
82 B-23	8/18/93	24.10 24.40	<0.01	<0.01	<0.01	<0.01	<0.01	NA	<0.01	<0.01	<0.01	<0.01	<0.01	<0.01	NA
82 B-22	8/18/93	24.40 24.70	<0.01	<0.01	<0.01	<0.01	<0.01	NA	<0.01	<0.01	<0.01	<0.01	<0.01	<0.01	NA
82 B-21	8/18/93	24.70 25.00	<0.01	<0.01	<0.01	<0.01	<0.01	NA	<0.01	<0.01	<0.01	<0.01	<0.01	<0.01	NA
82 B-20	8/18/93	25.00 25.30	<0.01	<0.01	<0.01	<0.01	<0.01	NA	<0.01	<0.01	<0.01	<0.01	<0.01	<0.01	NA
82 B-19	8/18/93	25.30 25.60	<0.01	<0.01	<0.01	<0.01	<0.01	NA	<0.01	<0.01	<0.01	<0.01	<0.01	<0.01	NA
82 B-18	8/18/93	25.60 25.90	<0.01	<0.01	<0.01	<0.01	<0.01	NA	<0.01	<0.01	<0.01	<0.01	<0.01	<0.01	NA
82 B-17	8/18/93	25.90 26.10	<0.01	<0.01	<0.01	<0.01	<0.01	NA	<0.01	<0.01	<0.01	<0.01	<0.01	<0.01	NA
82 B-16	8/18/93	26.10 26.40	<0.01	<0.01	<0.01	<0.01	<0.01	NA	<0.01	<0.01	<0.01	<0.01	<0.01	<0.01	NA
82 B-15	8/18/93	26.40 26.70	<0.01	<0.01	<0.01	<0.01	<0.01	NA	<0.01	<0.01	<0.01	<0.01	<0.01	<0.01	NA

TABLE 4.2 (Continued)
 FUEL HYDROCARBON COMPOUNDS DETECTED IN SOIL
 UST SITE 870 INTRINSIC REMEDIATION EE/CA
 HILL AFB, UTAH

Sample Location	Sample Date	Sample Interval Top (ft bgs)	Sample Interval Bottom (ft bgs)	Benzene (mg/kg)	Toluene (mg/kg)	Ethylbenzene (mg/kg)	P-Xylene (mg/kg)	M-Xylene (mg/kg)	M&P-Xylene (mg/kg)	O-Xylene (mg/kg)	Total Xylenes (mg/kg)	Total BTEX (mg/kg)	1,3,5-TMB (mg/kg)	1,2,4-TMB (mg/kg)	1,2,3-TMB (mg/kg)	TPH (mg/kg)
82 B-14	8/18/93	26.70	27.10	<0.01	<0.01	<0.01	<0.01	<0.01	NA	<0.01	<0.01	<0.01	<0.01	<0.01	<0.01	NA
82 B-13	8/18/93	27.10	27.40	<0.01	<0.01	<0.01	<0.01	<0.01	NA	<0.01	<0.01	<0.01	<0.01	<0.01	<0.01	NA
82 C-26	8/18/93	19.90	20.20	BLQ	BLQ	0.0118	0.0178	0.0418	NA	0.00716	0.06676	0.07856	0.029	0.0371	0.0145	<10.0
82 C-25	8/18/93	20.20	20.50	BLQ	BLQ	0.0124	0.0221	0.0521	NA	0.0136	0.0878	0.1002	0.0388	0.054	0.0229	<10.0
82 C-24	8/18/93	20.50	20.80	BLQ	BLQ	0.00795	0.0105	0.0189	NA	BLQ	0.0294	0.03735	0.0148	0.0168	0.00363	<10.0
82 C-23	8/18/93	20.80	21.10	BLQ	BLQ	0.00642	0.011	0.00991	NA	BLQ	0.0294	0.02733	0.0801	0.0741	0.00813	<10.0
82 C-22	8/18/93	21.10	21.40	0.00327	0.02	0.0286	0.0857	0.0662	NA	BLQ	0.1519	0.20377	3.7	4.42	0.905	352
82 C-21	8/18/93	21.40	21.55	0.00367	0.0192	0.00558	0.0365	0.00956	NA	BLQ	0.04606	0.07451	2.34	2.04	0.208	173
82 C-20	8/18/93	21.55	21.70	<0.01	0.0176	0.00618	0.0296	0.0091	NA	0.00401	0.04271	0.06649	1.5	1.03	0.0553	580(EST)
82 C-19	8/18/93	21.70	22.00	0.00621	<0.01	0.018	0.042	0.0257	NA	0.0151	0.0828	0.10701	1.65	1.16	0.108	444
82 C-16	8/18/93	22.10	22.30	<0.01	<0.01	<0.01	<0.01	<0.01	NA	<0.01	<0.01	<0.01	0.0139	0.0167	0.00491	<10.0
82 C-14	8/18/93	22.30	22.60	<0.01	<0.01	<0.01	<0.01	<0.01	NA	<0.01	<0.01	<0.01	<0.01	<0.01	<0.01	<10.0
82 D-06	8/20/93	21.50	21.80	BLQ	BLQ	<0.01	<0.01	<0.01	NA	<0.01	<0.01	<0.01	<0.01	<0.01	<0.01	NA
82 D-05	8/20/93	21.80	22.10	BLQ	BLQ	BLQ	BLQ	<0.01	NA	BLQ	BLQ	BLQ	BLQ	0.00498	BLQ	<10.0
82 D-04	8/20/93	22.10	22.40	BLQ	BLQ	0.00871	0.0136	0.0345	NA	0.00451	0.05261	0.06132	0.195	0.225	0.0548	<10.0
82 D-03	8/20/93	22.40	22.80	<0.01	BLQ	0.00335	BLQ	0.00336	NA	BLQ	0.00336	0.00671	0.0174	0.00885	0.00311	<10.0
82 D-01	8/20/93	23.80	24.00	0.00959	BLQ	0.0159	BLQ	BLQ	NA	BLQ	BLQ	0.02549	0.00416	BLQ	BLQ	<10.0
82 D-25	8/20/93	24.00	24.10	0.0103	BLQ	0.0106	0.00575	0.0143	NA	0.00359	0.02364	0.04454	0.00744	0.00702	BLQ	NA
82 D-24	8/20/93	24.10	24.40	0.129	BLQ	0.264	0.276	0.555	NA	0.144	0.975	1.368	0.373	0.44	0.135	<10.0
82 D-23	8/20/93	24.40	24.70	0.271	BLQ	1.48	1.62	3.4	NA	0.732	5.752	7.503	2.53	3.11	0.817	<10.0
82 D-22	8/20/93	24.70	25.00	0.0697	BLQ	0.111	0.013	BLQ	NA	BLQ	0.013	0.1937	0.0304	0.0111	BLQ	<10.0
82 D-21	8/20/93	25.00	25.30	0.0104	BLQ	0.0949	BLQ	0.00303	NA	BLQ	0.00303	0.10833	0.00477	0.0031	<0.01	NA
82 D-19	8/20/93	25.60	25.90	0.00829	BLQ	0.0604	0.0388	0.00529	NA	0.00577	0.04986	0.11855	0.0882	0.078	0.00821	NA
82 D-18	8/20/93	25.90	26.20	0.00792	BLQ	0.0344	BLQ	BLQ	NA	BLQ	BLQ	0.03232	0.0258	BLQ	<0.01	NA
82 D-17	8/20/93	26.20	26.50	0.0063	BLQ	0.0213	BLQ	BLQ	NA	BLQ	BLQ	0.0276	0.0147	BLQ	<0.01	<10.0
82 D-16	8/20/93	26.50	26.80	0.0316	0.00304	0.0613	0.0551	0.181	NA	0.045	0.2811	0.37704	0.0365	0.0399	0.0213	<10.0
82 D-15	8/20/93	26.80	27.00	0.0343	BLQ	0.0878	0.039	0.121	NA	0.0323	0.1923	0.3144	0.0433	0.0303	0.0127	<10.0
82 D-14	8/20/93	27.00	27.30	0.0209	BLQ	0.124	0.0662	0.0194	NA	BLQ	0.0856	0.2305	0.0637	0.00695	0.00518	<10.0
82 D-13	8/20/93	27.30	27.60	0.0185	BLQ	0.141	0.00755	0.0275	NA	0.00476	0.03981	0.19931	0.00871	0.00572	BLQ	NA
82 D-12	8/20/93	27.60	27.80	0.0203	BLQ	0.115	0.00454	0.0167	NA	BLQ	0.02124	0.15654	0.00632	0.00416	BLQ	NA
82 D-40	8/20/93	28.00	28.20	0.0314	BLQ	0.171	0.0378	0.111	NA	0.0242	0.173	0.3754	0.0439	0.0373	0.0163	NA
82 D-39	8/20/93	28.20	28.50	0.0388	BLQ	0.137	BLQ	0.00404	NA	0.00486	0.0189	0.1847	0.0077	BLQ	BLQ	NA
82 D-38	8/20/93	28.50	28.80	0.0393	0.00809	0.128	0.0105	0.101	NA	0.0692	0.1807	0.35609	0.0733	0.0107	0.0384	NA
82 E-03	8/21/93	2.70	3.00	<0.01	<0.01	<0.01	<0.01	<0.01	NA	<0.01	<0.01	<0.01	<0.01	<0.01	<0.01	NA
82 E-02	8/21/93	3.00	3.30	<0.01	<0.01	<0.01	<0.01	<0.01	NA	<0.01	<0.01	<0.01	<0.01	<0.01	<0.01	NA
82 E-17	8/21/93	4.90	5.25	<0.01	<0.01	<0.01	<0.01	<0.01	NA	<0.01	<0.01	<0.01	<0.01	<0.01	<0.01	NA

TABLE 4.2 (Continued)
 FUEL HYDROCARBON COMPOUNDS DETECTED IN SOIL
 UST SITE 870 INTRINSIC REMEDIATION EE/CA
 HILL AFB, UTAH

Sample Location	Sample Date	Sample Interval Top (ft bgs)	Sample Interval Bottom (ft bgs)	Benzene (mg/kg)	Toluene (mg/kg)	Ethylbenzene (mg/kg)	P-Xylene (mg/kg)	M-Xylene (mg/kg)	M&P-Xylene (mg/kg)	O-Xylene (mg/kg)	Total Xylenes (mg/kg)	Total BTEX (mg/kg)	1,3,5-TMB (mg/kg)	1,2,4-TMB (mg/kg)	1,2,3-TMB (mg/kg)	TPH (mg/kg)
82 E-15	8/21/93	5.60	5.95	<0.01	<0.01	<0.01	<0.01	<0.01	NA	<0.01	<0.01	<0.01	<0.01	<0.01	<0.01	NA
82 E-14	8/21/93	5.95	6.30	<0.01	<0.01	<0.01	<0.01	<0.01	NA	<0.01	<0.01	<0.01	<0.01	<0.01	<0.01	NA
82 E-13	8/21/93	6.30	6.65	<0.01	<0.01	<0.01	<0.01	<0.01	NA	<0.01	<0.01	<0.01	<0.01	<0.01	<0.01	NA
82 I-14	8/22/93	13.80	14.00	<0.01	BLQI	BLQI	BLQI	BLQI	NA	BLQI	BLQI	BLQI	BLQI	BLQI	BLQI	NA
82 I-13	8/22/93	14.00	14.40	BLQI	BLQI	BLQI	BLQI	BLQI	NA	BLQI	BLQI	BLQI	BLQI	BLQI	BLQI	NA
82 I-12	8/22/93	14.40	14.80	BLQI	BLQI	BLQI	BLQI	BLQI	NA	BLQI	BLQI	BLQI	BLQI	BLQI	BLQI	NA
82 I-11	8/22/93	14.80	15.20	BLQI	BLQI	BLQI	BLQI	BLQI	NA	BLQI	BLQI	BLQI	BLQI	BLQI	BLQI	NA
82 I-10	8/22/93	15.20	15.56	<0.01	BLQI	BLQI	BLQI	BLQI	NA	BLQI	BLQI	BLQI	BLQI	BLQI	BLQI	NA
82 I-09	8/22/93	15.56	15.92	BLQI	BLQI	BLQI	BLQI	BLQI	NA	BLQI	BLQI	BLQI	BLQI	BLQI	BLQI	NA
82 I-08	8/22/93	16.28	16.64	BLQI	BLQI	BLQI	BLQI	BLQI	NA	BLQI	BLQI	BLQI	BLQI	BLQI	BLQI	NA
82 I-07	8/22/93	16.64	17.00	BLQI	BLQI	BLQI	BLQI	BLQI	NA	BLQI	BLQI	BLQI	BLQI	BLQI	BLQI	138
82 I-06	8/22/93	16.64	17.00	BLQI	BLQI	BLQI	BLQI	BLQI	NA	BLQI	BLQI	BLQI	BLQI	BLQI	BLQI	139
82 I-05	10/21/93	17.00	17.36	0.0326	0.0266	14.5	19.9	52.7	NA	18.2	90.8	105.3592	28.1	49.9	18.5	3530
82 I-05	9/1/93	17.00	17.36	1.61	0.204	11.2	23.4	63.1	NA	19.9	106.4	119.414	29.3	50.9	19.3	NA
82 I-04	8/22/93	17.36	17.72	0.517	0.235	4.83	22.3	62.3	NA	20.8	105.4	110.482	23.3	42.7	15.4	11500
82 I-03	8/22/93	17.72	18.08	4.55	2.73	47.7	105	294	NA	100	499	553.98	88.8	167	59.2	28300
82 I-02	8/22/93	18.08	18.44	0.401	12.6	17.5	34.4	99.3	NA	36.6	170.3	200.801	36.8	69.8	25.3	5160
82 I-01	8/22/93	18.44	18.80	BLQI	0.142	0.556	1.22	3.67	NA	1.61	6.5	7.198	2.3	4.43	1.71	6080
82 I-27	8/22/93	18.80	19.12	0.49	1.73	0.377	0.625	1.84	NA	0.725	3.19	5.787	0.384	0.724	0.272	<10.0
82 I-26	8/22/93	19.12	19.45	0.749	3.75	1.03	1.7	4.74	NA	2.04	8.48	14.009	1.24	2.34	0.958	<10.0
82 I-25	8/22/93	19.45	19.77	0.866	0.231	0.187	0.281	0.802	NA	0.403	1.486	2.77	0.103	0.244	0.0909	<10.0
82 I-24	8/22/93	19.77	20.09	0.787	0.159	0.15	0.228	0.616	NA	0.31	1.154	2.25	0.0743	0.195	0.0749	<10.0
82 I-23	8/22/93	20.09	20.42	1.45	0.2	0.283	0.427	1.16	NA	0.567	2.154	4.087	0.157	0.402	0.155	<10.0
82 I-22	8/22/93	20.42	20.74	0.771	0.0936	0.15	0.233	0.621	NA	0.318	1.172	2.1866	0.0938	0.246	0.0899	<10.0
82 I-21	8/22/93	20.74	21.06	0.665	0.035	0.159	0.233	0.612	NA	0.321	1.166	2.025	0.0796	0.206	0.0783	NA
82 I-20	8/22/93	21.06	21.38	0.538	0.0436	0.152	0.221	0.604	NA	0.303	1.128	1.8616	0.0747	0.191	0.0709	NA
82 I-19	8/22/93	21.38	21.71	0.678	0.0455	0.16	0.243	0.517	NA	0.316	1.076	1.9595	0.0843	0.222	0.0778	NA
82 I-18	8/22/93	21.71	22.03	0.629	0.117	1.31	2.02	0.988	NA	2.31	5.318	7.374	1.62	4.72	1.25	276
82 I-17	8/22/93	22.03	22.35	0.653	0.591	3.39	4.69	4.89	NA	5.28	14.86	19.494	3.04	8.37	2.34	856(EST)
82 I-16	8/22/93	22.35	22.68	0.333	0.304	1.12	1.48	1.83	NA	1.72	5.03	6.87	0.857	2.33	0.672	<10.0
82 I-15	8/22/93	22.68	23.00	0.501	1.07	3.72	4.81	10.5	NA	5.58	20.89	26.181	2.94	8.45	2.03	643
82 I-39	8/22/93	23.00	23.40	0.422	0.0674	1.31	1.75	2.28	NA	1.03	5.06	6.8594	1.27	3.3	0.823	<10.0
82 I-38	8/22/93	23.20	23.40	0.315	0.0188	0.121	0.154	0.0592	NA	0.129	0.3422	0.797	0.031	0.113	0.031	<10.0
82 I-37	8/22/93	23.40	23.76	0.712	0.182	2.72	3.96	7.86	NA	4.79	16.61	20.224	2.32	5.38	1.5	340
82 I-36	8/22/93	23.76	24.12	0.0812	0.0154	0.0238	0.0364	0.0898	NA	0.085	0.2112	0.3316	0.0121	17.2	0.00937	<10.0
82 I-35	8/22/93	24.12	24.48	0.00831	0.0137	BLQI	BLQI	<0.01	NA	BLQI	0	0.02201	BLQI	BLQI	<0.01	<10.0
82 I-34	8/22/93	24.48	24.84	<0.01	0.0073	16.1	<0.01	<0.01	NA	<0.01	0	16.1073	<0.01	<0.01	<0.01	<10.0
82 I-33	8/22/93	24.84	25.20	<0.01	0.0122	27.1	<0.01	<0.01	NA	<0.01	0	27.1122	BLQI	BLQI	<0.01	<10.0

TABLE 4.2 (Concluded)
 FUEL HYDROCARBON COMPOUNDS DETECTED IN SOIL
 UST SITE 870 INTRINSIC REMEDIATION EE/CA
 HILL AFB, UTAH

Sample Location	Sample Date	Sample Interval Top (ft bgs) Bottom (ft bgs)	Benzene (mg/kg)	Toluene (mg/kg)	Ethylbenzene (mg/kg)	P-Xylene (mg/kg)	M-Xylene (mg/kg)	M&P-Xylene (mg/kg)	O-Xylene (mg/kg)	Total Xylenes (mg/kg)	Total BTEX (mg/kg)	1,3,5-TMB (mg/kg)	1,2,4-TMB (mg/kg)	1,2,3-TMB (mg/kg)	TPH (mg/kg)
82 I-32	8/22/93	25.20 25.56	0.0136	0.032	1.24	1.05	1.79	NA	0.0376	2.8776	4.1632	13.1	7.62	3.09	410(EST)
82 I-31	8/22/93	25.56 25.92	<0.01	0.0114	0.101	<0.01	0.0128	NA	BLQI	0.0128	0.1252	0.418	0.0191	0.259	<10.0
82 I-29	8/22/93	26.28 26.64	<0.01	0.0157	BLQI	BLQI	BLQI	NA	BLQI	0	0.0157	BLQI	BLQI	BLQI	NA
82 I-28	8/22/93	26.64 27.00	<0.01	0.0168	BLQI	BLQI	0.00884	NA	BLQI	0.00884	0.02564	BLQI	0.00524	BLQI	NA
82 I-30	8/22/93		<0.01	0.0111	BLQI	BLQI	BLQI	NA	BLQI	0	0.0111	BLQI	BLQI	BLQI	NA
MW-08	6/18/92	11.00 11.50	<0.005	0.031	0.12	NA	NA	NA	NA	0.92	0.963	NA	NA	NA	110
MW-05	6/17/92	15.50 16.00	2	0.11	0.26	NA	NA	NA	NA	2.8	5.17	NA	NA	NA	20
MW-01	11/6/91	16.00 17.00	0.15	0.129	0.057	NA	NA	0.203	0.115	0.318	0.654	NA	NA	NA	<10.0
MW-01A	6/29/92	17.00 17.50	10	23	16	NA	NA	NA	NA	74	123	NA	NA	NA	1500
MW-06	6/17/92	18.00 19.00	0.564	0.145	0.341	NA	NA	1.64	0.609	2.249	3.299	NA	NA	NA	98.3
MW-01A	7/1/92	21.00 21.50	0.009	<0.005	<0.005	NA	NA	NA	NA	<0.01	0.009	NA	NA	NA	<10.0
MW-09	6/29/92	59.50 60.00	<0.005	<0.005	<0.005	NA	NA	NA	NA	<0.01	0	NA	NA	NA	<10.0
SB870A-03	11/7/91	17.00 17.50	0.1	0.1	0.18	NA	NA	NA	NA	5.4	5.78	NA	NA	NA	360
SB870A-02	11/7/91	11.00 12.00	9.4	115	66.7	NA	NA	494	140	634	2.214	NA	NA	NA	2790
SB870A-02	11/7/91	15.00 16.00	0.0432	0.0513	0.0522	NA	NA	0.365	0.0923	0.4573	0.6399	NA	NA	NA	23.2
SB870A-03	11/7/91	17.00 18.00	0.013	0.0602	0.0577	NA	NA	0.386	0.123	0.509	0.604	NA	NA	NA	37
SB870A-03 d	11/7/91	19.00 20.00	0.338	0.595	0.138	NA	NA	0.867	0.276	1.143	825.1	NA	NA	NA	<10.0
SB870A-03 d	11/7/91	19.00 20.00	22.2	187	83.1	NA	NA	567	177	744	1036.3	NA	NA	NA	15100

* All samples with an 82 prefix are from EPA-82 series wells

See Appendix C for analytical methods

BLQI = Detected Below Limit of Quantification of 0.01 µg/mL

NA = Sample not analyzed for this parameter

EST = Estimated value reported by lab

NSN = No sample number

d = Duplicate sample

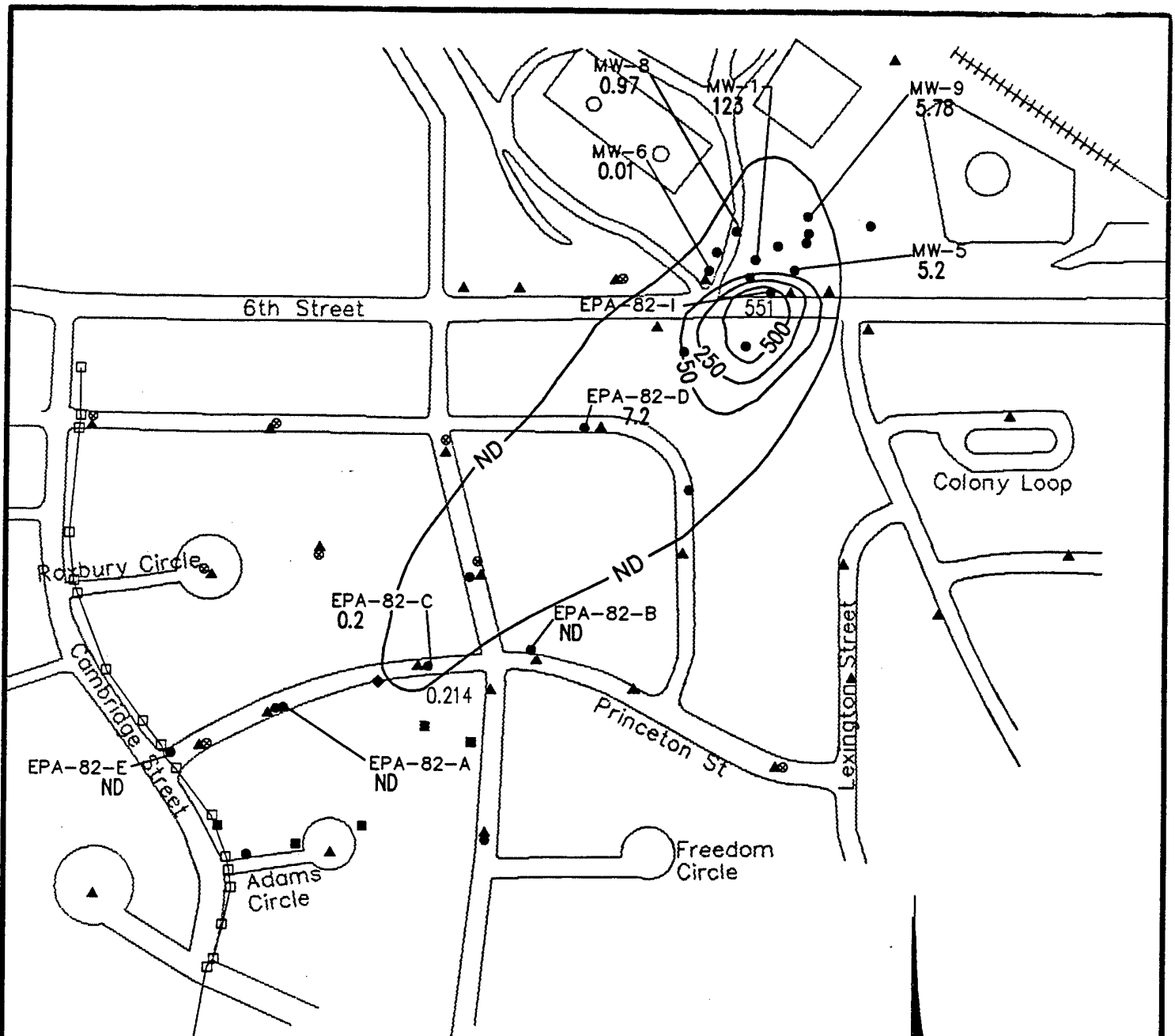

LEGEND

- ▲ CONE PENETROMETER TEST POINT/
PIEZOMETER
- MW-11 ● MONITORING WELL LOCATION
- ⊙ AUGUST 1993 GEOPROBE SAMPLING
LOCATION
- STORM DRAIN SURVEY LOCATION
- JULY 1994 GEOPROBE SAMPLING
LOCATION
- ◆ JULY 1994 SOIL BORING LOCATION
- 1.00 — LINE OF EQUAL BTEX
CONCENTRATION (mg/kg)
DRAWN AT INTERNAL OF GREATEST
CONCENTRATION
- ND NOT DETECTED (<0.01 mg/kg)
CONTOUR INTERVAL = VARIABLE



FIGURE 4.2

**TOTAL BTEX ISOPLETH
FOR SOIL**

UST Site 870
Intrinsic Remediation EE/CA
Hill Air Force Base, Utah

**PARSONS
ENGINEERING SCIENCE, INC.**

Denver, Colorado

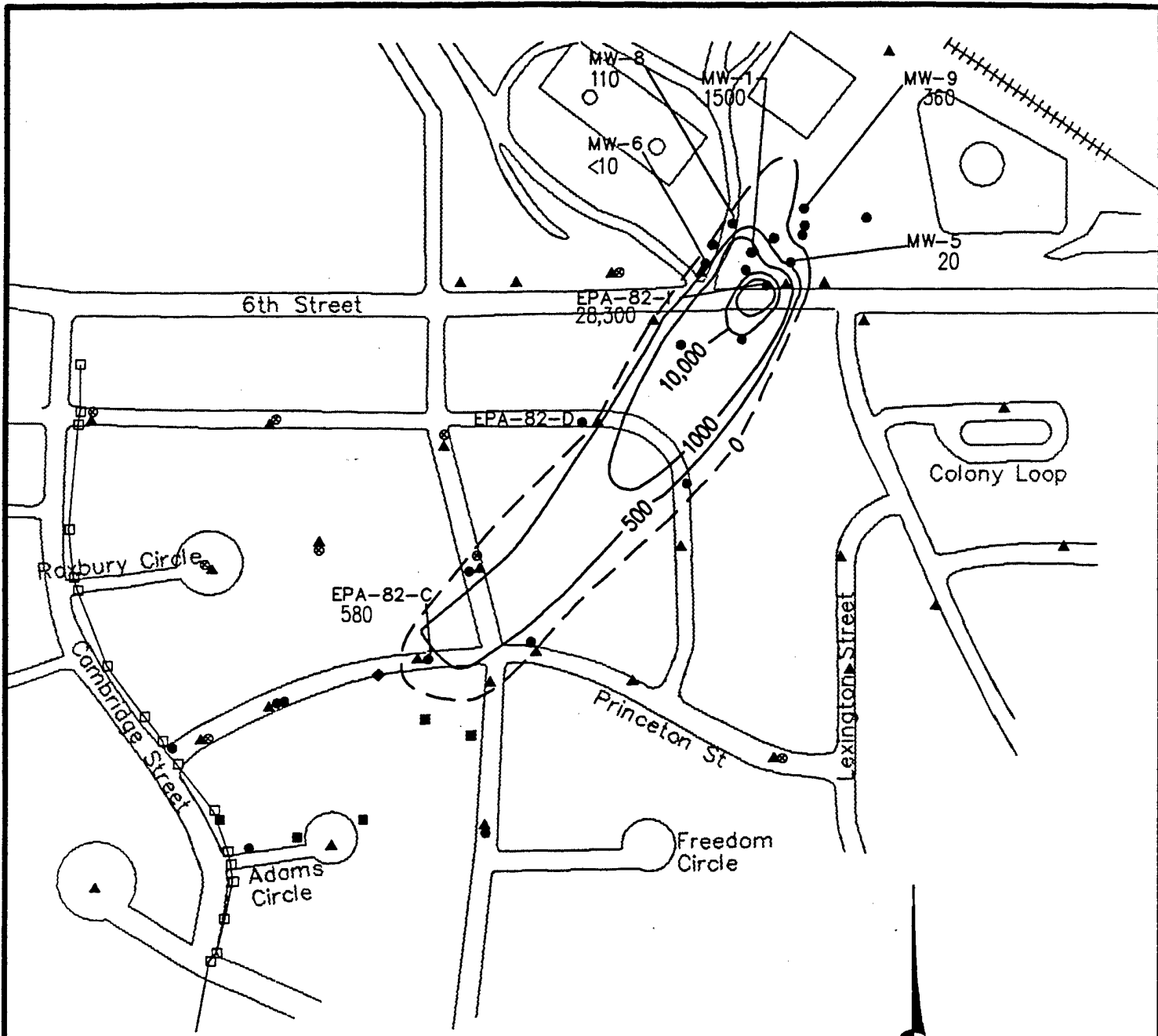

LEGEND

- CPT-26 ▲ CONE PENETROMETER TEST POINT/
PIEZOMETER
- MW-11 ● MONITORING WELL LOCATION
- AUGUST 1993 GEOPROBE SAMPLING
LOCATION
- STORM DRAIN SURVEY LOCATION
- EPA-82-M ■ JULY 1994 GEOPROBE SAMPLING
LOCATION
- EPA-82-KK ◆ JULY 1994 SOIL BORING LOCATION
- 500 — LINE OF EQUAL TOTAL PETROLEUM
HYDROCARBON CONCENTRATION (mg/kg)
(DASHED WHERE INFERRED)



FIGURE 4.3

**TOTAL PETROLEUM
HYDROCARBON ISOPLETH
MAP FOR SOIL**

UST Site 870
Intrinsic Remediation EE/CA
Hill Air Force Base, Utah

**PARSONS
ENGINEERING SCIENCE, INC.**
Denver, Colorado

contamination at concentrations above 100 mg/kg in the soil is approximately 7 feet at EPA-82-I, which is in the vicinity of the initial fuel release into the soil. This 7-foot-thick zone of elevated TPH concentrations extends above and below the ground water table. Downgradient areas with residual-phase contamination have TPH levels as high as 580 mg/kg, but the contaminated zones are less than 1 foot thick. Theoretically, because BTEX is a subset of TPH, the areas of BTEX and TPH contamination should be the same. However, because of the higher detection limit associated with the TPH analytical method, the area of detected TPH is slightly smaller than the area with elevated BTEX concentrations at this site.

4.2.3 Total Organic Carbon

TOC concentrations are used to estimate the amount of organic matter sorbed on soil particles or trapped in the interstitial passages of a soil matrix. The TOC concentration in the saturated zone is an important parameter used to estimate the amount of contaminant that could potentially be sorbed to the aquifer matrix. Sorption results in slowing (retardation) of the contaminant plume relative to the average advective ground water velocity. Background measurements of TOC were taken from core samples obtained from soil boring EPA-82-E. The TOC in the soil at this point ranges from 0.069 to 0.094 percent (Table 4.3).

TABLE 4.3
TOTAL ORGANIC CARBON IN SOIL
UST SITE 870 INTRINSIC REMEDIATION EE/CA
HILL AFB, UTAH

Sample Location	Soil Filtrate (% OC)	Solids (% OC)	Total Soil (% OC)	Mean + 1 Standard Deviation Soil % TOC
82E-12-1 (6.65 - 7.00 feet bgs ^v)	0.007	0.046	0.053	0.069+0.019
82E-12-2 (6.65 - 7.00 feet bgs)	0.009	0.056	0.065	
82E-12-3 (6.65 - 7.00 feet bgs)	0.007	0.083	0.09	
82E-14-1 (5.95 - 6.30 feet bgs)	0.007	0.074	0.081	0.070+0.011
82E-14-2 (5.95 - 6.30 feet bgs)	0.006	0.062	0.068	
82E-14-3 (5.95 - 6.30 feet bgs)	0.006	0.054	0.06	
82E-15-1 (5.60 - 5.95 feet bgs)	0.014	0.071	0.085	0.087+0.004
82E-15-2 (5.60 - 5.95 feet bgs)	0.018	0.074	0.092	
82E-15-3 (5.60 - 5.95 feet bgs)	0.012	0.073	0.085	
82E-17-1 (4.90 - 5.25 feet bgs)	0.011	0.101	0.112	0.094+0.017
82E-17-2 (4.90 - 5.25 feet bgs)	0.011	0.078	0.089	
82E-17-3 (4.90 - 5.25 feet bgs)	0.012	0.068	0.08	
LECO STANDARD DEVIATION SOIL		1.022		
		1.034		
LECO STANDARD DEVIATION SOIL T.V.		1.00+0.04		

^v feet bgs = feet below ground surface.

Soil TOC samples were collected just below the phreatic surface for accurate estimates of TOC in the shallow saturated zone. EPA-82-E was selected as a TOC sampling location because it was located outside of mobile or residual LNAPL contaminated soils (which would compromise TOC readings) and directly downgradient of potential plume migration. As a result, the soil TOC at EPA-82-E is indicative of the potential sorptive potential in the shallow aquifer directly downgradient of anticipated plume migration. The TOC estimate compares favorably with literature values defining TOC contents in relatively clean, sandy soils (0.01 percent TOC).

4.3 GROUND WATER CHEMISTRY

4.3.1 Dissolved-Phase BTEX Contamination

Laboratory analytical results for ground water samples collected during previous site investigations indicated the presence of fuel-hydrocarbon contamination in the shallow saturated zone in the vicinity of UST Site 870. Ground water samples collected in August 1993 by Parsons ES and RSKERL personnel confirmed these results. Additional ground water samples collected in July 1994 suggest that natural attenuation of BTEX compounds is occurring at this site. Table 4.4 summarizes available ground water contaminant data. Two ground water samples from the site appear to have unrealistically high total BTEX concentrations ranging from 52.7 mg/L (TP-07 = CPT-07) to 14,400 mg/L (CPT-14). The work of Smith *et al.* (1981) suggests that the maximum dissolved-phase BTEX concentration that can result from the equilibrium partitioning of BTEX compounds from JP-4 into ground water is approximately 30 mg/L. Unrealistically high total BTEX concentrations generally result from LNAPL emulsification during sampling. The highest dissolved-phase total BTEX concentration observed at the site that can be considered reliable is 26,576 µg/L. This sample was collected from well MW-03 in August, 1992. This well contained mobile LNAPL but this total BTEX concentration is within the range suggested by Smith *et al.* (1981) and is consistent with samples collected from other wells containing mobile LNAPL (EPA-82-I = 21,475 µg/L and EPA-82-J = 16,336 µg/L).

To evaluate trends in BTEX loss over the site, data sets from different sampling periods were combined to form BTEX isopleth maps for 1993 and 1994 (described in preceding paragraphs). Although generally not a concern, the various ground water analytical methods used to sample ground water from different site characterization studies (1992 to 1994) were judged for their

TABLE 4.4
 FUEL HYDROCARBON COMPOUNDS DETECTED IN GROUND WATER
 UST SITE 870 INTRINSIC REMEDIATION EE/CA
 HILL AFB, UTAH

Sample Location	Sample Date	Easting	Northing	Benzene (µg/L)	Toluene (µg/L)	Ethylbenzene (µg/L)	P-Xylene (µg/L)	M-Xylene (µg/L)	M&P-Xylene (µg/L)	O-Xylene (µg/L)	Total Xylenes (µg/L)	Total BTEX (µg/L)	1,3,5-TMB (µg/L)	1,2,4-TMB (µg/L)	1,2,3-TMB (µg/L)
MONITORING WELL SAMPLING LOCATIONS															
EPA-82-A	8/19/93	1546.62	2945.1	<1	<1	<1	<1	<1	NA	<1	<1	<1	<1	<1	<1
EPA-82-A	11/8/93	1546.62	2945.1	<1	BLQI	<1	<1	<1	NA	<1	<1	BLQI	1.14	0.965	BLQI
EPA-82-A	7/94	1546.62	2945.1	<1	<1	<1	<1	<1	NA	<1	<1	<1	<1	<1	<1
EPA-82-B	8/20/93	2062.23	3063.44	<1	4.29	<1	<1	<1	NA	<1	<1	4.29	1.06	1.43	<1
EPA-82-B	11/8/93	2062.23	3063.44	<1	<1	<1	<1	<1	NA	<1	<1	<1	<1	<1	<1
EPA-82-B d	11/8/93	2062.23	3063.44	<1	<1	<1	<1	<1	NA	<1	<1	<1	<1	<1	<1
EPA-82-B d	7/94	2062.23	3063.44	<1	<1	<1	<1	<1	NA	<1	<1	<1	<1	<1	<1
EPA-82-C	8/20/93	1840.49	3035.78	4.92	3.13	26.5	42.8	47.2	NA	2.62	92.62	127.17	238	324	120
EPA-82-C	11/9/93	1840.49	3035.78	<1	6.38	6.81	20.2	6.38	NA	1.82	28.4	41.59	79.7	68.9	64.1
EPA-82-C	7/94	1840.49	3035.78	7.28	9.74	22.7	25.9	18.3	NA	3.18	47.38	87.1	144	143	42.9
EPA-82-D	8/21/93	2167.57	3507.69	95.8	10.4	147	149	383	NA	103	635	888.2	129	183	88.8
EPA-82-D	11/9/93	2167.57	3507.69	174	4.64	30.8	141	293	NA	57.5	491.5	700.94	89.4	119	77.1
EPA-82-D	7/94	2167.57	3507.69	458	9.71	454	272	442	NA	50.7	764.7	1686.41	125	176	60.4
EPA-82-E	8/22/93	1345.36	2845.36	<1	<1	<1	<1	<1	NA	<1	<1	<1	<1	<1	<1
EPA-82-E	11/8/93	1345.36	2845.36	<1	<1	<1	<1	<1	NA	<1	<1	<1	<1	<1	<1
EPA-82-E	7/94	1345.36	2845.36	<1	<1	<1	<1	<1	NA	<1	<1	<1	<1	<1	<1
EPA-82-F	8/21/93	1543.19	2943.57	<1	<1	<1	<1	<1	NA	<1	<1	<1	<1	<1	<1
EPA-82-F	11/9/93	1543.19	2943.57	<1	<1	<1	<1	<1	NA	<1	<1	<1	<1	<1	<1
EPA-82-F	7/94	1543.19	2943.57	ND	ND	ND	<1	<1	NA	ND	<1	<1	ND	<1	ND
EPA-82-F d	7/94	1543.19	2943.57	ND	ND	ND	<1	<1	NA	ND	<1	<1	ND	<1	ND
EPA-82-H	8/21/93	1964.51	2719.71	<1	<1	<1	<1	<1	NA	<1	<1	<1	<1	<1	<1
EPA-82-H	11/8/93	1964.51	2719.71	<1	<1	<1	<1	<1	NA	<1	<1	<1	<1	<1	<1
EPA-82-H	7/94	1964.51	2719.71	<1	<1	<1	<1	<1	NA	<1	<1	<1	<1	<1	<1
EPA-82-I (a)	11/93	2520.42	3771.26	2740	372	486	784	1370	NA	1140	3294	6892	162	495	240
EPA-82-I	7/94	2520.42	3771.26	5600	5870	955	1620	5130	NA	2300	9050	21475	417	1270	436
EPA-82-J	7/94	NA	NA	4260	3910	816	1370	4220	NA	1760	7350	16336	485	1310	515
MW-01	11/18/91	2475.32	3841.98	305	690	132	NA	NA	NA	NA	2283	3410	NA	NA	NA
MW-01	12/93-1/94	2475.32	3841.98	475	88	183	NA	NA	NA	NA	1160	1906	330	680	NA
MW-02	12/93-1/94	2389.21	3846.24	51	56.3	73.3	NA	NA	NA	NA	776	956.6	350	750	NA
MW-03	08/6/92	2533.09	3882.19	12179	6728	<5	NA	NA	4300	3369	7669	26576	NA	NA	NA
MW-03	10/92	2533.09	3882.19	12.18	6.73	<1	NA	NA	NA	NA	7.67	26.58	NA	NA	NA
MW-03	12/93-1/94	2533.09	3882.19	2320	1300	376	NA	NA	NA	NA	5470	9466	480	1000	NA
MW-04	12/93-1/94	2446.7	3798.05	930	1830	450	NA	NA	NA	NA	5120	8330	550	1500	NA
MW-05	09/30/92	2536.47	3813.49	74	<50	160	NA	NA	NA	NA	900	1134	NA	NA	NA
MW-05 d	09/30/92	2536.47	3813.49	76	<50	150	NA	NA	NA	NA	890	1116	NA	NA	NA
MW-05	12/93-1/94	2536.47	3813.49	416	250	246	NA	NA	NA	NA	2508	3420	450	960	NA
MW-06	9/92	2389.06	3794.35	<25	<25	<25	NA	NA	NA	NA	<25	<25	NA	NA	NA
MW-06	09/04/92	2389.06	3794.35	<25	<25	<25	NA	NA	NA	NA	<25	<25	NA	NA	NA
MW-06	12/93-1/94	2389.06	3794.35	24.5	10.1	18.6	NA	NA	NA	NA	155.9	209.1	650	1500	NA

TABLE 4.4 (Continued)
 FUEL HYDROCARBON COMPOUNDS DETECTED IN GROUND WATER
 UST SITE 870 INTRINSIC REMEDIATION EE/CA
 HILL AFB, UTAH

Sample Location	Sample Date	Easting	Northing	Benzene (µg/L)	Toluene (µg/L)	Ethylbenzene (µg/L)	P-Xylene (µg/L)	M-Xylene (µg/L)	M&P-Xylene (µg/L)	O-Xylene (µg/L)	Total Xylenes (µg/L)	Total BTEX (µg/L)	1,3,5-TMB (µg/L)	1,2,4-TMB (µg/L)	1,2,3-TMB (µg/L)
MW-07	9/92	2621.27	3900.79	<5	<5	<5	NA	NA	NA	NA	<5	<5	NA	NA	NA
MW-07 (TWP-3)	09/07/92	2621.27	3900.79	<5	<5	<5	NA	NA	NA	NA	<5	<5	NA	NA	NA
MW-07 d	09/07/92	2621.27	3900.79	<5	<5	<5	NA	NA	NA	NA	<5	<5	NA	NA	NA
MW-07	12/93-1/94	2621.27	3900.79	<1	<1	<1	NA	NA	NA	NA	<1	<1	<1	<1	NA
MW-08	12/93-1/94	2449.7	3893.96	18.6	10.8	29.3	NA	NA	NA	NA	314.4	373.1	140	280	NA
MW-09	12/93-1/94	2529.21	3930.05	72	27	35	NA	NA	NA	NA	558	692	150	650	NA
MW-10	10/92	2354.84	3397.6	1.16	0.57	0.06	NA	NA	NA	NA	0.27	2.06	NA	NA	NA
MW-10 d	10/92	2354.84	3397.6	<5	17	<0.5	NA	NA	NA	NA	110	127	NA	NA	NA
MW-10	10/01/92	2354.84	3397.6	<5	17	<5	NA	NA	NA	NA	110	127	NA	NA	NA
MW-10	8/18/93	2354.84	3397.6	<10	290	443	401	2470	NA	1280	4151	4884	575	828	607
MW-10 d	8/18/93	2354.84	3397.6	<2	340	543	471	2880	NA	1490	4841	5724	713	974	683
MW-10	11/9/93	2354.84	3397.6	7.44	62.9	190	189	1090	NA	505	1784	2044.34	174	297	212
MW-10	7/94			20	54.7	182	190	847	NA	441	1478	1734.7	215	303	197
MW-11	09/30/92	1923.08	3213.91	26	33	21	NA	NA	NA	NA	180	260	NA	NA	NA
MW-11	8/18/93	1923.08	3213.91	336	90.3	139	230	635	NA	204	1069	1634.3	71.8	165	69.3
MW-11	9/93	1923.08	3213.91	26	33	21	NA	NA	NA	NA	180	260	NA	NA	NA
MW-11	11/9/93	1923.08	3213.91	105	46.5	39.9	65	221	NA	86.4	372.4	563.8	30	55.7	28.7
MW-11	7/94			ND	ND	<1	<1	<1	NA	<1	<1	<1	<1	<1	<1
MW-12	10/92	2457.72	3650.34	<5	<5	29	NA	NA	NA	NA	300	329	NA	NA	NA
MW-12	10/01/92	2457.72	3650.34	10	<5	29	NA	NA	NA	NA	300	329	NA	NA	NA
MW-12	7/94			<1	<1	0.9	7.82	9.45	NA	17.3	34.57	35.47	9.89	36.2	13.3
MW-13	12/93-1/94	SDNA	SDNA	2690	1570	589	NA	NA	NA	NA	4280	9129	470	1113	NA
MW-14	12/93-1/94	SDNA	SDNA	941	2800	505	NA	NA	NA	NA	5510	9756	650	1400	NA
GEOPROBE SAMPLING LOCATIONS															
71-8 CPT (depth 1)		2547.88	3772.45	<1	BLQI	<1	<1	<1	NA	2.2	2.2	2.2	<1	<1	<1
71-17 CPT (depth 1)	8/3/93	1528.38	3493.12	<1	<1	<1	<1	<1	NA	<1	<1	<1	<1	<1	<1
71-17 CPT (depth 2)	8/3/93	1528.38	3493.12	<1	<1	<1	<1	<1	NA	<1	<1	<1	<1	<1	<1
71-18 CPT (depth 1)	8/3/93	1885.05	3457.77	<1	1.27	<1	<1	BLQI	NA	<1	BLQI	1.27	<1	1.1	1.08
71-18 CPT (depth 2)	8/3/93	1885.05	3457.77	<1	<1	<1	<1	<1	NA	<1	<1	<1	<1	<1	<1
71-19 CPT (depth 1)	8/2/93	1948.46	3215.91	51.4	BLQI	461	869	2730	NA	984	4583	5095.4	295	735	330
71-19 CPT (depth 1)d	8/2/93	1948.46	3215.91	NA	NA	NA	NA	NA	NA	NA	NA	NA	NA	NA	NA
71-23 CPT (depth 1)	8/5/93	2526.12	2835.21	<1	BLQI	<1	<1	<1	NA	<1	<1	<1	<1	<1	<1
71-23 CPT (depth 1)	8/2/93	1400.23	2863.23	<1	<1	<1	<1	<1	NA	<1	<1	<1	<1	<1	<1
71-29 CPT (depth 2)	8/2/93	1400.23	2863.23	<1	<1	<1	<1	<1	NA	<1	<1	<1	<1	<1	<1
71-31 CPT (depth 1)	8/3/93	1418.19	3205.92	<1	<1	<1	<1	<1	NA	<1	<1	<1	<1	<1	<1
71-31 CPT (depth 1)	8/3/93	1418.19	3205.92	<1	<1	<1	<1	<1	NA	<1	<1	<1	<1	<1	<1
71-31 CPT (depth 2)	8/3/93	1418.19	3205.92	<1	<1	<1	<1	<1	NA	<1	<1	<1	<1	<1	<1

TABLE 4.4 (Continued)
 FUEL HYDROCARBON COMPOUNDS DETECTED IN GROUND WATER
 UST SITE 870 INTRINSIC REMEDIATION EE/CA
 HILL AFB, UTAH

Sample Location	Sample Date	Easting	Northing	Benzene (µg/L)	Toluene (µg/L)	Ethylbenzene (µg/L)	P-Xylene (µg/L)	M-Xylene (µg/L)	M&P-Xylene (µg/L)	O-Xylene (µg/L)	Total Xylenes (µg/L)	Total BTEX (µg/L)	1,3,5-TMB (µg/L)	1,2,4-TMB (µg/L)	1,2,3-TMB (µg/L)
71-39 CPT (depth 1)	8/5/93	2758.65	4145.21	<1	<1	<1	<1	<1	NA	<1	<1	<1	<1	<1	<1
71-39 CPT (depth 2)	8/5/93	2758.65	4145.21	<1	<1	<1	<1	<1	NA	<1	<1	<1	<1	<1	<1
71-39 CPT (depth 2)d	8/5/93	2758.65	4145.21	NA	NA	NA	NA	NA	NA	NA	NA	NA	NA	NA	NA
EPA-82-K	7/94	1458.62	2656.22	<1	<1	<1	<1	<1	NA	<1	<1	<1	ND	<1	ND
EPA-82-L1	7/94	-8055.75	2834.32	6	18.1	103	379	572	NA	604	1555	1682.1	396	433	223
EPA-82-L2	7/94	-8055.75	2834.32	4.01	18.8	9.72	23.8	49.2	NA	35.8	108.8	141.33	22	28.6	15.2
EPA-82-L3	7/94	-8055.75	2834.32	1.44	7.19	4	8.53	20.2	NA	12.9	41.63	54.26	7.43	13.8	8.88
EPA-82-M	7/94	1700.5	2698.09	<1	3	1.58	2.89	7.59	NA	4.95	15.43	20.01	2.33	4.56	3.06
EPA-82-M d	7/94	1700.5	2698.09	<1	3.1	1.5	2.77	7.63	NA	5.1	15.5	20.1	2.23	4.33	2.93
EPA-82-N	7/94	1425.23	2738.09	<1	<1	<1	<1	<1	NA	<1	<1	<1	ND	<1	<1
EPA-82-O	7/94	1594.5	2688.82	<1	<1	<1	<1	<1	NA	<1	<1	<1	ND	<1	<1
EPA-82-P	7/94	1776.37	2865.35	<1	<1	3.5	11.5	18.8	NA	5.99	36.29	39.79	77.7	159	57.9
CONE PENETROMETER SAMPLING LOCATIONS															
CPT-07	08/07/92	2547.88	3772.45	<500	<500	1800	NA	NA	4600	1900	6500	8300	NA	NA	NA
CPT-07	09/30/92	2547.88	3772.45	680	34(EST)	1400	NA	NA	NA	NA	5700	7814	NA	NA	NA
CPT-10	10/19/92	2602.28	3772.04	<5	11	16	NA	NA	NA	NA	160	187	NA	NA	NA
CPT-14	12/18/92	2182.6	3507.6	<250,000	<250,000	1400000	NA	NA	NA	NA	13000000	14400000	NA	NA	NA
CPT-40	11/24/92	2758.65	4145.21	<1	<1	<1	NA	NA	<1	<1	<1	<1	NA	NA	NA
CPT-42	11/24/93	3067.32	3238.57	<1	<1	<1	NA	NA	<1	<1	<1	<1	NA	NA	NA
CPT-42	11/30/92	3067.32	3238.57	<1	<1	<1	NA	NA	<1	<1	<1	<1	NA	NA	NA
CPT-43	11/24/93	2683.44	3014.06	<1	<1	<1	NA	NA	<1	<1	<1	<1	NA	NA	NA
CPT-43	11/30/92	2683.44	3014.06	<1	<1	<1	NA	NA	<1	<1	<1	<1	NA	NA	NA
TP-01	08/5/92	SDNA	SDNA	741	2273	<5	NA	NA	540	487	1027	4041	NA	NA	NA
TP-02	08/5/92	SDNA	SDNA	5203	7578	740	NA	NA	1903	2274	4177	17698	NA	NA	NA
TP-03	08/10/92	SDNA	SDNA	2701	3112	322	NA	NA	801	854	1655	7790	NA	NA	NA
TP-07	08/5/92	2547.88	3772.45	26092	21919	753	NA	NA	1459	2447	3906	52670	NA	NA	NA
TP-09	08/6/92	SDNA	SDNA	992	2128	173	NA	NA	211	90	301	3594	NA	NA	NA
TP-10	08/6/92	2602.28	3772.04	1928	3214	<5	NA	NA	1854	1976	3830	8972	NA	NA	NA
TP-12	08/7/92	2354.84	3397.6	1163	565	62	NA	NA	215	50	265	2055	NA	NA	NA
TP-13	08/7/92	2062.91	3060.14	<5	69	<5	NA	NA	62	<5	62	131	NA	NA	NA
TP-14	08/7/92	2182.6	3507.6	1440	338	338	NA	NA	930	448	1378	3548	NA	NA	NA
TP-17	08/8/92	1528.38	3493.12	<5	<5	14	NA	NA	57	<5	57	71	NA	NA	NA
TP-19	08/8/92	1948.46	3215.91	646	<5	36	NA	NA	149	<5	149	831	NA	NA	NA
TP-20	08/8/92	1848.28	3037.59	124	2699	<5	NA	NA	<5	504	504	3327	NA	NA	NA
TP-21	08/8/92	2349.56	3244.25	<5	<5	<5	NA	NA	<5	<5	57	57	NA	NA	NA
TP-22	08/9/92	SDNA	SDNA	56	90	22	NA	NA	68	36	104	272	NA	NA	NA
TP-36	08/13/92	2670.91	3231.11	<5	<5	<5	NA	NA	52	<5	52	52	NA	NA	NA
TP-37	08/13/92	1970.3	2978.15	789	930	<5	NA	NA	2410	1769	4179	5898	NA	NA	NA
TWP-01	08/12/92	SDNA	SDNA	520	1271	85	NA	NA	141	32	173	2049	NA	NA	NA

TABLE 4.4 (Concluded)
 FUEL HYDROCARBON COMPOUNDS DETECTED IN GROUND WATER
 UST SITE 870 INTRINSIC REMEDIATION EE/CA
 HILL AFB, UTAH

Sample Location	Sample Date	Eastings	Northing	Benzene (µg/L)	Toluene (µg/L)	Ethylbenzene (µg/L)	P-Xylene (µg/L)	M-Xylene (µg/L)	M&P-Xylene (µg/L)	O-Xylene (µg/L)	Total Xylenes (µg/L)	Total BTEX (µg/L)	1,3,5-TMB (µg/L)	1,2,4-TMB (µg/L)	1,2,3-TMB (µg/L)
STORM SEWER SAMPLING LOCATIONS															
STORM-2	8/93	1430.1	2443.98	<1	<1	<1	<1	<1	NA	<1	<1	<1	<1	<1	<1
STORM-3	8/93	1445.12	2511.52	<1	<1	<1	<1	<1	NA	<1	<1	<1	<1	<1	<1
MISCELLANEOUS SAMPLING LOCATIONS															
870-WS-1/32'	11/23/92	SDNA	SDNA	17.4	1.8	BLQ1	NA	NA	4.9	1.3	6.2	25.4	NA	NA	NA
870-WS-1/42'	11/23/92	SDNA	SDNA	30.5	113	56.4	NA	NA	369	103	472	671.9	NA	NA	NA
870-WS-1/52'	11/24/92	SDNA	SDNA	27	59.3	21.6	NA	NA	107	36.4	143.4	251.3	NA	NA	NA
870-WS-2/49 d	11/24/92	SDNA	SDNA	6.5	7.8	1.7	NA	NA	12.2	3.4	15.6	31.6	NA	NA	NA
870-WS-2/49'	11/24/92	SDNA	SDNA	8.4	13.8	4.5	NA	NA	30.2	9.4	39.6	66.3	NA	NA	NA
870-WS-2/59'	11/24/92	SDNA	SDNA	24	68	50.7	NA	NA	294	93.7	387.7	530.4	NA	NA	NA
870-WS-2/69'	11/24/92	SDNA	SDNA	43.5	71.7	38.2	NA	NA	258	63.6	321.6	475	NA	NA	NA
GWS-01	08/14/92	SDNA	SDNA	195	946	72	NA	NA	62	27	89	1302	NA	NA	NA
SGS-01	08/05/92	SDNA	SDNA	161	12645	46	NA	NA	<5	295	295	13147	NA	NA	NA
SGS-1	08/07/92	SDNA	SDNA	7.7	<5	5.5	NA	NA	8.8	19	27.8	41	NA	NA	NA

See Appendix C for analytical methods

(a)=Headspace data

d = Sample duplicate

BLQ1=Detected below Limit of Quantification of 1 µg/L

BLQ2=Detected below Limit of Quantification of 4 µg/L

BLQ3=Detected below Limit of Quantification of 2 µg/L

BLQ4=Detected below Limit of Quantification of 10 µg/L

NA = Sample not analyzed for this parameter

EST = Estimated value reported by lab

SDNA=Surveyor's data not available

quantitative comparability. Method RSKOP-124 was used by Parsons ES to quantitate aqueous BTEX concentrations during August 1993 and 1994 sampling events. RSKOP-124 is a dual-column, gas-chromatograph/mass spectroscopy (GC/MS) technique that has resolution capabilities that are superior to EPA SW-846 Methods 8020/602, 8015M, and 8240 (used for volatile and semi-volatile organic analysis by JMM in 1992). All analytical techniques used for VOC analysis in the different site characterization studies from 1992 to 1994 had identical, achievable detection limits of 1 µg/L and adequate compound resolution capabilities. Hence, comparison of different ground water data sets are not compromised by underestimation or overestimation of a particular analytical technique. Groundwater extraction and preparation techniques used by JMM in 1992 are not available; however, potential differences in sampling technique were predicted to be minor because ground water sampling techniques are fairly standardized.

Figure 4.4 is an isopleth map that shows the distribution of total BTEX dissolved in ground water through August 1993. Because this figure was used for Bioplume II model input (to be conservative) the highest total BTEX concentrations observed in ground water between August 1992 and August 1993 were used to prepare this figure. This figure also includes data collected from monitoring wells in the source area north of Sixth Street in December 1993/January 1994 (MW-01, MW-02, and MW-04 through MW-09). These wells cover a very small area relative to the areal extent of the plume and in some cases these data represent the only data available for this area. As a result, Figure 4.4 represents the most conservative representation of the 1993 BTEX plume based on available data. BTEX contamination is migrating to the southwest in the direction of ground water flow. During the period through August 1993, the BTEX plume was approximately 1,650 feet long and 750 feet wide at the widest point.

Figure 4.5 is an isopleth map that shows the distribution of total BTEX dissolved in ground water in July 1994. Like Figure 4.4, this figure also includes data collected from monitoring wells in the source area in December 1993/January 1994 (MW-01 through MW-09) to illustrate the BTEX plume for 1994. Comparison of Figures 4.4 and 4.5 suggests that a reduction in the areal extent of the BTEX plume occurred between September 1992/August 1993 and July 1994. With the exception of total BTEX concentrations in some of the monitoring wells located in the area containing mobile LNAPL (wells MW-05, MW-06, EPA-82-D), dissolved-phase total BTEX concentrations were seen to decline over this period. The increased concentrations in these wells could be the result of a fresh spill in the source area. Figure 4.4 shows that through

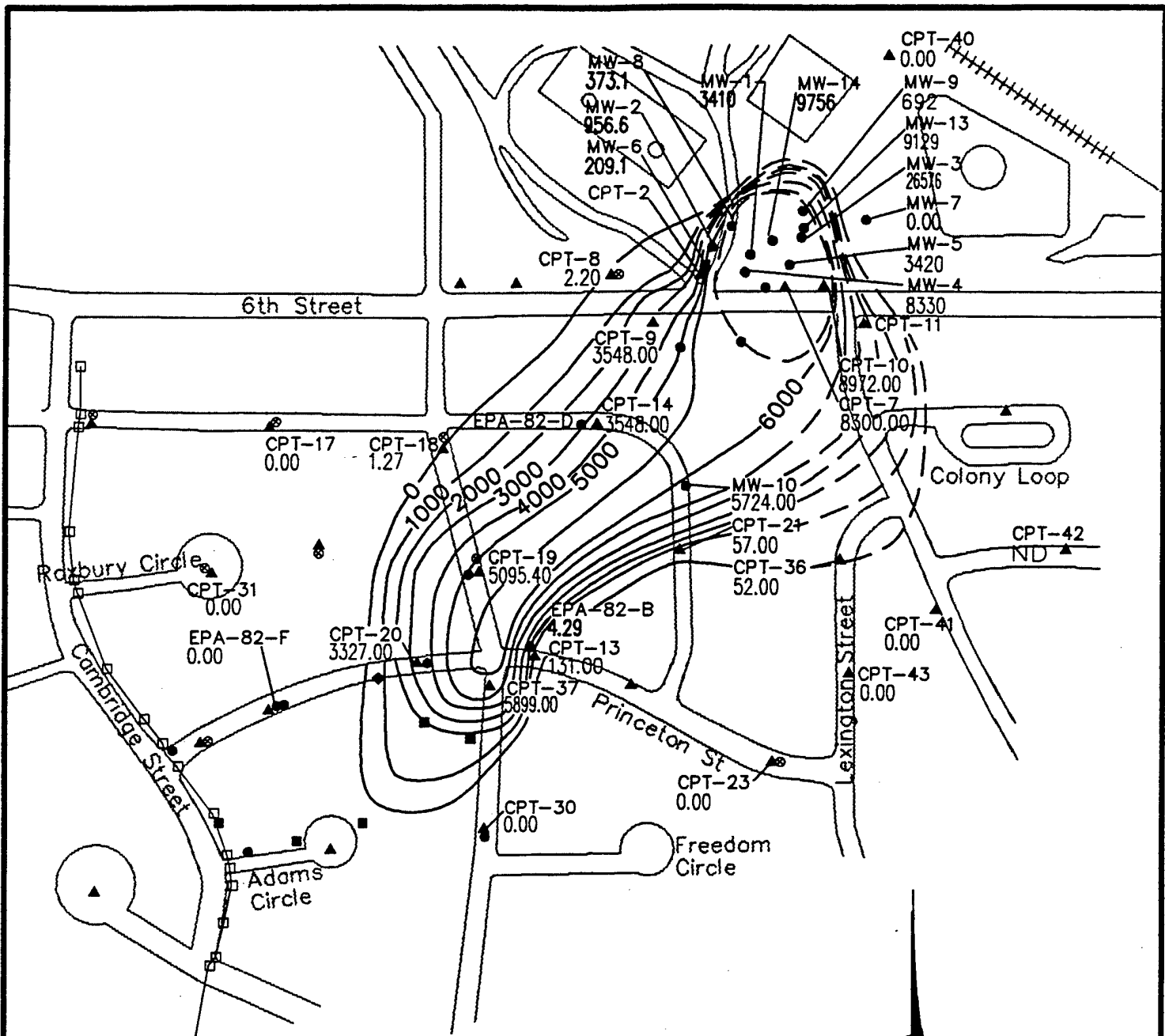

LEGEND

- CPT-26 ▲ CONE PENETROMETER TEST POINT/
PIEZOMETER
 - MW-11 ● MONITORING WELL LOCATION
 - AUGUST 1993 GEOPROBE SAMPLING
LOCATION
 - STORM DRAIN SURVEY LOCATION
 - EPA-82-M ■ JULY 1994 GEOPROBE SAMPLING
LOCATION
 - EPA-82-KK ◆ JULY 1994 SOIL BORING LOCATION
 - 1000— LINE OF EQUAL TOTAL BTEX
CONCENTRATION (µg/L)
(HIGHEST LEVELS FROM AUGUST
1992 THROUGH AUGUST 1993)
 - ND NOT DETECTED
- CONTOUR INTERVAL = 1000 mg/L



FIGURE 4.4
TOTAL BTEX ISOPLETH
FOR GROUNDWATER
THROUGH AUGUST 1993

UST Site 870
 Intrinsic Remediation EE/CA
 Hill Air Force Base, Utah

PARSONS
ENGINEERING SCIENCE, INC.
 Denver, Colorado

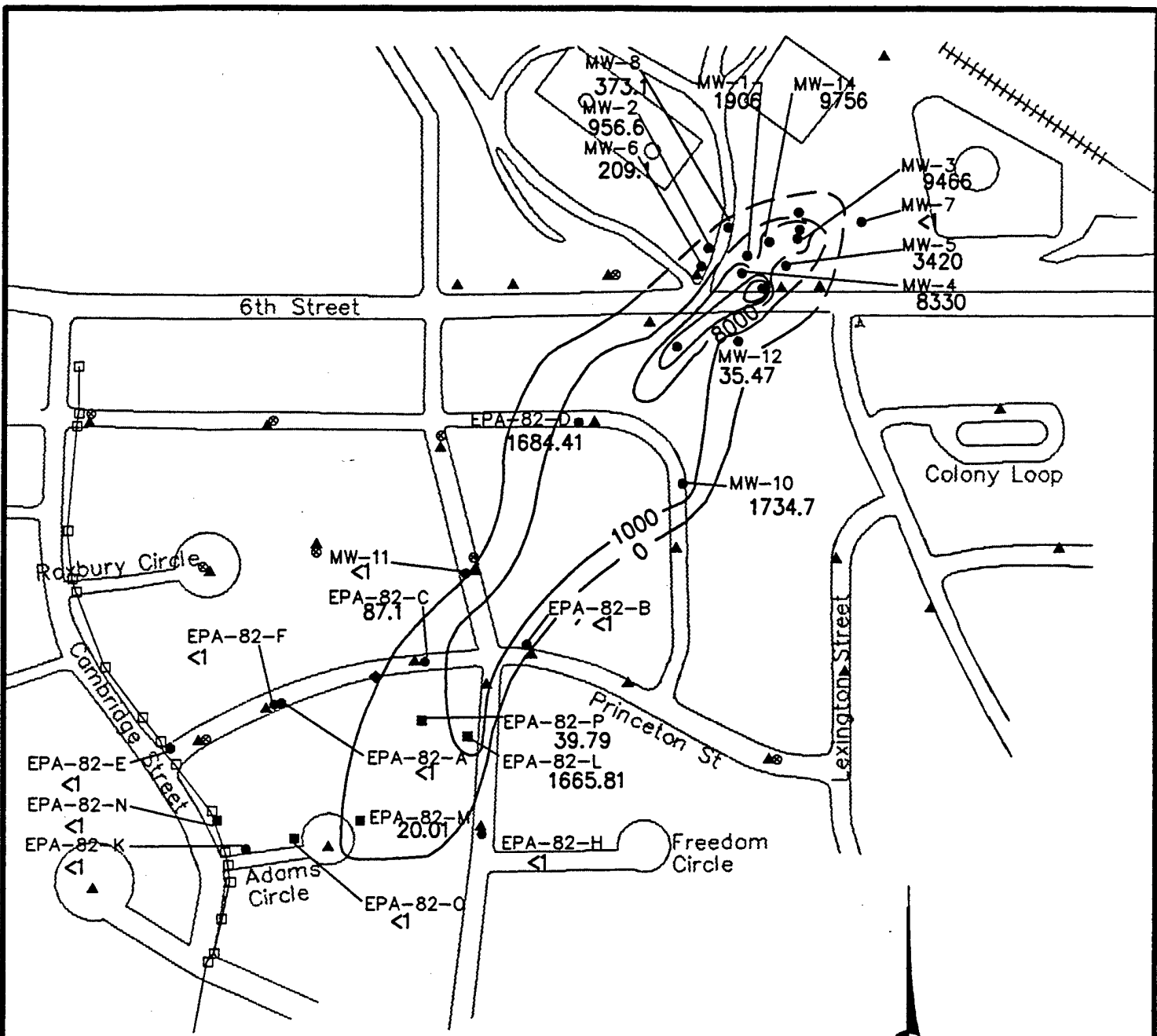

LEGEND

- CPT-26 ▲ CONE PENETROMETER TEST POINT/
PIEZOMETER
- MW-11 ● MONITORING WELL LOCATION
- ⊙ AUGUST 1993 GEOPROBE SAMPLING
LOCATION
- STORM DRAIN SURVEY LOCATION
- EPA-82-M ■ JULY 1994 GEOPROBE SAMPLING
LOCATION
- EPA-82-KK ◆ JULY 1994 SOIL BORING LOCATION
- 1000 — LINE OF EQUAL BTEX
CONCENTRATION (ug/L)
(DASHED WHERE INFERRED)

CONTOUR INTERVAL = VARIABLE



FIGURE 4.5

**TOTAL BTEX ISOPLETH
FOR GROUNDWATER
JULY 1994**

UST Site 870
Intrinsic Remediation EE/CA
Hill Air Force Base, Utah

**PARSONS
ENGINEERING SCIENCE, INC.**

Denver, Colorado

August 1993, the majority of the dissolved-phase BTEX plume had concentrations in excess of 5,000 micrograms per liter ($\mu\text{g/L}$), whereas Figure 4.5 shows that in July 1994, the majority of the dissolved-phase BTEX plume had concentrations below 2,000 $\mu\text{g/L}$. Because Figure 4.4 was prepared with the highest BTEX concentrations observed between August 1992 and August 1993, comparison of these two figures may suggest rates of intrinsic remediation that are somewhat high. Available geochemical data suggest that this reduction in the areal extent and concentration of the total BTEX plume was primarily the result of biodegradation, as discussed in the following sections.

4.3.2 Inorganic Chemistry and Geochemical Indicators of Biodegradation

Microorganisms obtain energy for cell production and maintenance by catalyzing the transfer of electrons from electron donors to electron acceptors. This results in the oxidation of the electron donor and the reduction of the electron acceptor. Electron donors at UST Site 870 are natural organic carbon and fuel hydrocarbon compounds. Fuel hydrocarbons are completely degraded or detoxified if they are utilized as the primary electron donor for microbial metabolism (Bouwer, 1992). Electron acceptors are elements or compounds that occur in relatively oxidized states and include oxygen, nitrate, ferrous iron, sulfate, and carbon dioxide. Microorganisms preferentially utilize electron acceptors while metabolizing fuel hydrocarbon (Bouwer, 1992). Dissolved oxygen is utilized first as the prime electron acceptor. After the DO is consumed, anaerobic microorganisms use electron acceptors in the following order of preference: nitrate, ferrous iron, sulfate, and finally carbon dioxide. Anaerobic destruction of the BTEX compounds is associated with the accumulation of fatty acids, production of methane, solubilization of iron, and reduction of nitrate and sulfate (Cozzarelli *et al.*, 1990; Wilson *et al.*, 1990).

4.3.2.1 Dissolved Oxygen

DO concentrations were measured at Geoprobe[®] locations and monitoring points/wells in August 1993, November 1993, December 1993/January 1994, and July 1994. Table 4.5 summarizes DO concentrations. Figure 4.6 is an isopleth map showing the distribution of DO in ground water in August 1993. This figure includes data collected from monitoring wells in the source area north of Sixth Street in December 1993/January 1994. These wells cover a small area and these data represent the only data available for this area. Figure 4.7 is an isopleth map showing the distribution of DO in ground water in July 1994. This figure also includes data collected from monitoring wells in the source area in December 1993/January 1994. Comparison

TABLE 4.5
GROUND WATER GEOCHEMICAL DATA
UST SITE 870 INTRINSIC REMEDIATION EE/CA
HILL AFB, UTAH

Sample Location	Sample Date	Water Temp. (°C)	Dissolved Oxygen (mg/L)	Redox Potential (mV)	Total Alkalinity (mg/L)	Conductivity (µS/cm)	pH	Chloride (mg/L)	Sulfate (mg/L)	Ferrous Iron (mg/L)	Ammonia (mg/L)	Nitrate (mg/L)	Nitrite (mg/L)	NO2+NO3 Nitrogen (mg/L)	Methane (mg/L)	TOC (mg/L)
EPA-82-A	8/19/93	16.5	0.4	170	576	1677	7.2	170	66.4	<0.05	<0.05	NA	NA	0.14	0.001	4.2
EPA-82-A	11/8/93	14.8	0.3	NA	NA	NA	7.4	159	60.5	0.17	NA	NA	NA	0.08	0.001	2.2
EPA-82-A	7/7/94	16.3	<0.5	240	530	1622	7.2	156.0	58.6	<0.05	NA	NA	NA	<0.05	0.001	2.8
EPA-82-B	8/20/93	16.9	1	213	450	1421	6.9	163	76.9	<0.05	<0.05	NA	NA	0.25	0.001	2.1
EPA-82-B	11/8/93	12.9	1.2	NA	NA	NA	7.5	144	72.2	0.11	NA	NA	NA	0.37	<0.001	3.1
EPA-82-B	7/7/94	19.1	<0.5	125	428	1406	7.2	145.0	74.2	0.1	NA	NA	NA	0.15	0.001	2.2
EPA-82-C	8/20/93	15.5	0.5	-125	745	1828	6.9	164	49.9	2.1	<0.05	NA	NA	0.13	0.002	9.4
EPA-82-C duplicate	8/20/93	NA	NA	NA	NA	NA	NA	161	NA	NA	NA	NA	NA	NA	NA	9.5
EPA-82-C	11/9/93	14.2	0.4	NA	NA	NA	6.3	109	17.2	0.84	NA	NA	NA	0.08	0.002	6
EPA-82-D	8/21/93	15.9	1.3	40	959	2520	7.3	198	193 (EST)	0.4	0.07	NA	NA	0.53	<0.001	8.1
EPA-82-D duplicate	8/21/93	NA	NA	NA	NA	NA	NA	NA	NA	NA	0.05	NA	NA	0.53	NA	NA
EPA-82-D	11/9/93	14.1	0.8	NA	NA	NA	7.2	151	116	1.7	NA	NA	NA	0.13	<0.001	5.2
EPA-82-D duplicate	11/9/93	NA	NA	NA	NA	NA	NA	NA	NA	NA	NA	NA	NA	NA	NA	5.3
EPA-82-D	7/7/94	17	<0.5	-138	657	1905	7.3	221.0	<0.5	7.4	NA	NA	NA	<0.05	0.002	10.3
EPA-82-E	8/22/93	22.8	5.6	192	349	1042	7.3	77.1	39.6	<0.05	<0.05	NA	NA	4.4	<0.001	1.7
EPA-82-E duplicate	8/22/93	NA	NA	NA	NA	NA	NA	78.3	39.8	NA	NA	NA	NA	NA	NA	NA
EPA-82-E	11/8/93	16.5	2.7	NA	NA	NA	7.4	76.4	65.8	0.02	NA	NA	NA	5.61	<0.001	1.9
EPA-82-E	7/7/94	22.6	3.7	106	357	2020	7.1	354.0	37.0	<0.05	<0.05	NA	NA	4.39	0.001	1.7
EPA-82-F	8/21/93	22.6	1.1	243	550	1275	7.5	68.5	63.9	<0.05	<0.05	NA	NA	7.41	0.019	2.2
EPA-82-F duplicate	8/21/93	NA	NA	NA	NA	NA	NA	71.8	67.9	NA	<0.05	NA	NA	7.46	NA	NA
EPA-82-F	11/9/93	16.8	1.1	NA	NA	NA	7.6	60.2	55.5	0.04	NA	NA	NA	5.07	0.006	1.9
EPA-82-F duplicate	11/93	NA	NA	NA	NA	NA	NA	60.7	55	NA	NA	NA	NA	5.06	NA	NA
EPA-82-F	7/7/94	21.5	<0.5	-70	490	1172	7.3	46.9	52.3	0.5	NA	NA	NA	1.67	0.577	4.4
EPA-82-H	8/22/93	18	6.3	190	485	1400	7.1	136	59.7	<0.05	<0.05	NA	NA	2.12	<0.001	2.2
EPA-82-H	11/8/93	15.7	5.4	NA	NA	NA	7.4	104	55.7	0.19	NA	NA	NA	2.01	<0.001	1.6
EPA-82-H	7/7/94	14.7	5.9	272	492	1384	7.2	129.0	62.3	<0.05	NA	NA	NA	1.51	0.001	2.6
EPA-82-I	11/93	NA	NA	NA	NA	NA	NA	NA	NA	NA	NA	NA	NA	NA	0.68	NA
EPA-82-I	7/8/94	16.3	0.7	-90	491	1124	7.1	76.7	<0.5	10.3	NA	NA	NA	<0.05	1.886	67.1
EPA-82-J	7/12/94	14.7	2.2	NA	430	1280	7.0	158.0	<0.5	1.3	NA	NA	NA	0.05	0.052	46
MW-01	12/93-1/94	NA	0.3	NA	NA	NA	NA	NA	2	10.8	NA	<0.05	<0.01	<0.05	0.041	NA
MW-01 duplicate	12/93-1/94	NA	NA	NA	NA	NA	NA	NA	NA	NA	NA	NA	NA	NA	0.042	NA
MW-02	12/93-1/94	NA	0.4	NA	NA	NA	NA	NA	40	50.5	NA	0.25	<0.01	0.25	<0.0003	NA
MW-03	12/93-1/94	NA	1.5	NA	NA	NA	NA	NA	<2	8.2	NA	<0.05	0.025	<0.05	0.459	NA
MW-04	12/93-1/94	NA	1.4	NA	NA	NA	NA	NA	<2	13.6	NA	1.68	0.637	2.32	0.012	NA
MW-05	12/93-1/94	NA	0.7	NA	NA	NA	NA	NA	<2	6.41	NA	<0.05	<0.01	<0.05	2.04	NA
MW-06	12/93-1/94	NA	0.8	NA	NA	NA	NA	NA	21	10.3	NA	0.04	0.031	0.07	0.002	NA
MW-07	12/93-1/94	NA	4.6	NA	NA	NA	NA	NA	26	1.36	NA	11.78	0.021	11.8	<0.001	NA
MW-08	12/93-1/94	NA	0.2	NA	NA	NA	NA	NA	11	5.22	NA	0.28	<0.01	0.28	0.006	NA
MW-09	12/93-1/94	NA	NA	NA	NA	NA	NA	NA	22	2.07	NA	0.4	0.577	0.4	0.006	NA
MW-10	8/18/93	15.4	0.6	125	518	1162	7.1	44.7	63.2	<0.05	<0.05	NA	NA	9.16	0.004	27.8
MW-10	11/9/93	15	1.5	NA	NA	NA	7.4	33.9	53.1	0.22	NA	NA	NA	17.4	0.001	5.3
MW-10 duplicate	11/9/93	NA	NA	NA	NA	NA	NA	NA	NA	NA	NA	NA	NA	17.1	NA	NA
MW-10	7/7/94	16.6	<0.5	-190	502	1076	7.3	47.1	19.5	0.8	NA	NA	NA	2.67	0.006	9.3

TABLE 4.5 (Concluded)
GROUND WATER GEOCHEMICAL DATA
UST SITE 870 INTRINSIC REMEDIATION EE/CA
HILL AFB, UTAH

Sample Location	Sample Date	Water Temp. (°C)	Dissolved Oxygen (mg/L)	Redox Potential (mV)	Total Alkalinity (mg/L)	Conductivity (µS/cm)	pH	Chloride (mg/L)	Sulfate (mg/L)	Ferrous Iron (mg/L)	Ammonia (mg/L)	Nitrate (mg/L)	Nitrite (mg/L)	NO2+NO3 Nitrogen (mg/L)	Methane (mg/L)	TOC (mg/L)
MONITORING WELL SAMPLING LOCATIONS (Continued)																
MW-11	8/18/93	14.8	0.1	66	543	1209	7	48.7	97.6	0.2	0.25	NA	NA	0.36	0.117	8
MW-11 duplicate	8/18/93	NA	NA	NA	NA	NA	NA	NA	98	0.2	NA	NA	NA	NA	0.095	8
MW-11	11/9/93	14.7	0.1	NA	NA	NA	7.4	29.5	94.1	0.05	NA	NA	NA	0.17	0.022	4
MW-11 duplicate	11/9/93	NA	NA	NA	NA	NA	NA	NA	NA	NA	NA	NA	NA	NA	NA	3.8
MW-11	7/8/94	15.8	<0.5	140	504	1125	7.0	27.0	99.0	<0.05	NA	NA	NA	<0.05	0.005	3.5
MW-12	7/8/94	15.3	<0.5	171	450	959	7.1	13.2	29.2	<0.05	NA	NA	NA	7.73	0.005	2.4
MW-13	12/93-1/94	NA	NA	NA	NA	NA	NA	NA	3	10.3	NA	0.06	0.037	0.1	0.498	NA
MW-13 duplicate	12/93-1/94	NA	NA	NA	NA	NA	NA	NA	NA	NA	NA	NA	NA	NA	0.483	NA
MW-14	12/93-1/94	NA	NA	NA	NA	NA	NA	NA	27.0	5.96	NA	1.72	0.187	1.91	0.023	NA
MW-14 duplicate	12/93-1/94	NA	NA	NA	NA	NA	NA	NA	NA	NA	NA	NA	NA	NA	0.023	NA
GEOPROBE SAMPLING LOCATIONS																
71-17 CPT (depth 1)	8/3/93	24	5.8	135	384	1127	7.3	71.5	74.4	<0.05	0.3	NA	NA	3.78	0.0044	3.6
71-17 CPT (depth 1)	8/3/93	22.2	5.2	NA	NA	NA	NA	NA	NA	NA	NA	NA	NA	NA	NA	NA
71-17 CPT (depth 2)	8/3/93	22	1.1	-10	451	1495	7.3	189	8.05	0.2	0.21	NA	NA	2.13	0.0064	2.1
71-18 CPT (depth 1)	8/3/93	NA	NA	NA	NA	NA	NA	109	34.8	0.2	0.26	NA	NA	1.85	0.0007	NA
71-18 CPT (depth 1)	8/3/93	NA	NA	NA	NA	NA	NA	108	34.6	NA	0.17	NA	NA	1.91	NA	NA
71-18 CPT (depth 2)	8/3/93	20	1.1	180	440	1151	7.4	90.2	39.4	<0.05	0.11	NA	NA	3.89	0.0017	1.6
71-18 CPT (depth 2)	8/3/93	NA	NA	NA	NA	NA	NA	90.3	39.8	0.6	NA	NA	NA	NA	NA	NA
71-19 CPT (depth 1)	8/2/93	25	0.5	-63	612	1196	7.1	50.5	5.68	0.6	0.99	NA	NA	0.19	0.0564	5.4
71-19 CPT (depth 1)	8/2/93	NA	NA	NA	NA	NA	NA	NA	NA	NA	NA	NA	NA	NA	0.0552	NA
71-23 CPT (depth 1)	8/5/93	19	NA	274	632	1451	7.4	118	51.2	0.1	0.14	NA	NA	2.7	0.0001	2.1
71-23 CPT (depth 2)	8/5/93	18.7	4.3	NA	NA	NA	NA	NA	NA	NA	NA	NA	NA	NA	NA	NA
71-29 CPT (depth 1)	8/2/93	25	2	99	457	1604	7.1	NA	NA	<0.05	0.3	NA	NA	1.4	0.0007	2.7
71-29 CPT (depth 2)	8/2/93	22.5	NA	-137	452	1256	7.4	107	52.6	<0.05	<0.05	NA	NA	3.9	0.0541	1.9
71-29 CPT (depth 2)	8/2/93	NA	NA	NA	NA	NA	NA	NA	NA	NA	NA	NA	NA	NA	NA	2
71-29 CPT (depth 7)	8/2/93	NA	NA	NA	NA	NA	NA	NA	NA	NA	0.19	NA	NA	1.59	NA	NA
71-31 CPT (depth 1)	8/3/93	25	NA	162	394	1099	7.3	93.2	46.9	0.1	<0.05	NA	NA	3.66	0.0032	2.7
71-31 CPT (depth 1)	8/3/93	NA	4.5	NA	NA	NA	NA	NA	NA	NA	NA	NA	NA	NA	NA	NA
71-31 CPT (depth 2)	8/3/93	23	4.2	152	378	1082	7.3	91.7	47.4	<0.05	<0.05	NA	NA	4.69	0.0111	1.9
71-38 CPT (depth 1)	8/3/93	NA	NA	NA	NA	NA	NA	170	58	NA	<0.05	NA	NA	3.77	0.035	3.3
71-38 CPT (depth 1)	8/3/93	NA	NA	NA	NA	NA	NA	NA	NA	NA	NA	NA	NA	NA	NA	3.3
71-38 CPT (depth 2)	8/3/93	18	1.8	56	646	1628	7.3	NA	NA	<0.05	NA	NA	NA	NA	NA	NA
71-39 CPT (depth 1)	8/5/93	21	NA	179	592	1525	7.7	161	56.8	0.05	<0.05	NA	NA	4.17	0.0141	2.8
71-39 CPT (depth 1)	8/5/93	NA	NA	NA	NA	NA	NA	114	31.5	<0.05	<0.05	NA	NA	4.13	NA	2.9
71-39 CPT (depth 2)	8/5/93	24	NA	207	451	1321	8.3	114	31.5	<0.05	<0.05	NA	NA	NA	NA	NA
71-39 CPT (depth 2)	8/5/93	NA	NA	NA	NA	NA	NA	116	NA	NA	NA	NA	NA	NA	NA	NA
71-8 CPT (depth 1)	8/93	NA	NA	NA	NA	NA	NA	112.0	NA	NA	NA	NA	NA	NA	NA	8
EPA-82-L1	7/9/94	17.2	<0.5	-106	730	1662	7.1	112.0	<0.5	2.4	NA	NA	NA	<0.05	0.018	5.6
EPA-82-L1 duplicate	7/9/94	NA	NA	NA	NA	NA	NA	NA	NA	NA	NA	NA	NA	<0.05	NA	4.4
EPA-82-L2	7/9/94	17.6	<0.5	-30	732	1584	7.1	86.4	36.0	0.1	NA	NA	NA	0.05	0.003	3.1
EPA-82-L3	7/9/94	18.6	<0.5	208	706	1530	7.3	90.1	61.0	0.1	NA	NA	NA	0.3	0.002	2.4
EPA-82-M	7/9/94	18.8	1.2	208	666	1450	7.3	73.8	35.4	<0.05	NA	NA	NA	1.8	0.121	2.9
EPA-82-N	7/11/94	20.6	2.0	250	256	1278	7.4	120.0	42.6	<0.05	NA	NA	NA	1.14	0.004	3.7
EPA-82-O	7/11/94	17.7	0.5	120	566	1403	7.4	78.4	37.1	<0.05	NA	NA	NA	1.63	0.001	2.8
EPA-82-K	7/11/94	20.9	2.0	197	498	1171	7.8	60.0	59.8	<0.05	NA	NA	NA	4.44	0.003	2.4
EPA-82-P	7/11/94	NA	<0.5	NA	792	1671	7.4	148.0	<0.5	0.2	NA	NA	NA	<0.05	0.004	6.8

See Appendix C for analytical methods
ES1=Estimated value reported by lab

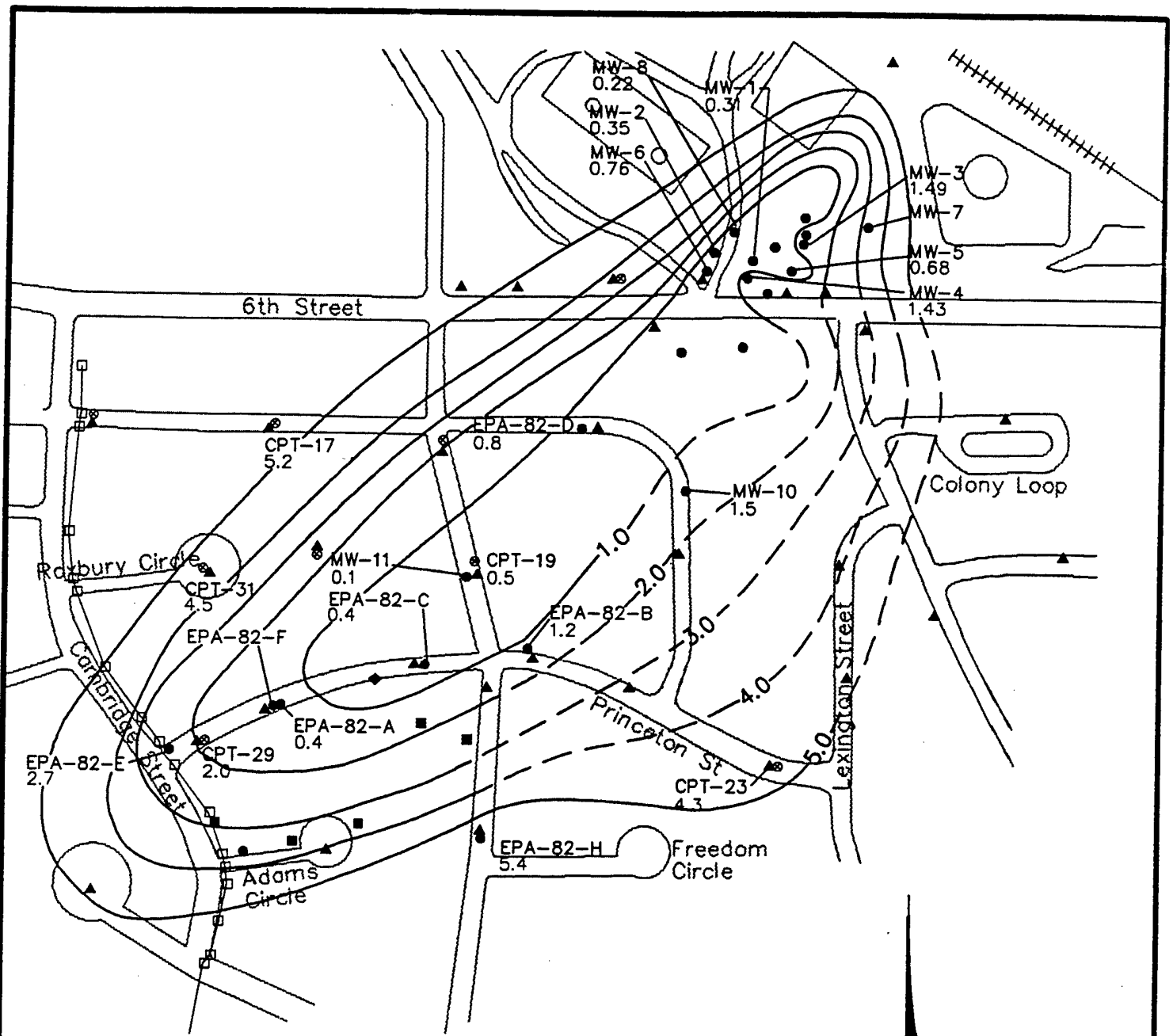

LEGEND

- CPT-26 ▲ CONE PENETROMETER TEST POINT/
PIEZOMETER
- MW-11 ● MONITORING WELL LOCATION
- ⊙ AUGUST 1993 GEOPROBE SAMPLING
LOCATION
- STORM DRAIN SURVEY LOCATION
- EPA-82-M ■ JULY 1994 GEOPROBE SAMPLING
LOCATION
- EPA-82-KK ◆ JULY 1994 SOIL BORING LOCATION
- 2.0— LINE OF EQUAL DISSOLVED OXYGEN
CONCENTRATION (mg/L)(AUGUST 1993)
(DASHED WHERE INFERRED)

CONTOUR INTERVAL = 1.0 mg/L



FIGURE 4.6
DISSOLVED OXYGEN
ISOPLETH FOR GROUNDWATER
AUGUST 1993

UST Site 870
Intrinsic Remediation EE/CA
Hill Air Force Base, Utah

PARSONS
ENGINEERING SCIENCE, INC.

Denver, Colorado

of Figures 4.4 and 4.6 and Figures 4.5 and 4.7 shows graphically that areas with elevated total BTEX concentrations have depleted DO concentrations. This is a strong indication that aerobic biodegradation of the BTEX compounds is occurring at the site.

In the absence of microbial cell production, the oxidation (biodegradation) of benzene to carbon dioxide and water is given by:

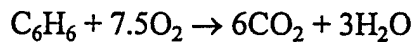

Therefore, 7.5 moles of oxygen are required to mineralize 1 mole of benzene. On a mass basis, the ratio of oxygen to benzene is given by:

Molecular weights:	Benzene	$6(12) + 6(1) = 78$ gm/mole
	Oxygen	$7.5(32) = 240$ gm/mole

$$\text{Mass Ratio of Oxygen to Benzene} = 240/78 = 3.08:1$$

In the absence of microbial cell production, 3.08 mg of oxygen are required to completely mineralize 1 mg of benzene. Similar calculations can be completed for toluene (3.13 mg oxygen to 1 mg toluene), ethylbenzene (3.17 mg oxygen to 1 mg ethylbenzene), and the xylenes (3.17 mg oxygen to 1 mg xylene). The average mass ratio of oxygen consumed to total BTEX degraded is thus 3.14:1. This means that approximately 0.32 mg of BTEX is mineralized to carbon dioxide and water for every 1.0 mg of DO consumed. With a background DO concentration of approximately 6 mg/L, the shallow ground water at this site has the capacity to assimilate 1.9 mg/L (1,900 $\mu\text{g/L}$) of total BTEX. This is a very conservative estimate of the assimilative capacity of DO because microbial cell mass production was not taken into account by the stoichiometry shown above.

When cell mass production is accounted for, the mineralization of benzene to carbon dioxide and water is given by:

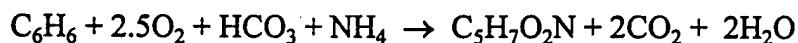

From this it can be seen that only 2.5 moles of DO are required to mineralize 1 mole of benzene when cell mass production is taken into account. On a mass basis, the ratio of DO to benzene is given by:

Molecular weights:	Benzene	$12(6) + 1(6) = 78$ gm/mole
	Oxygen	$2.5(32) = 80$ gm/mole

$$\text{Mass Ratio of Oxygen to Benzene} = 80/78 = 1.03:1$$

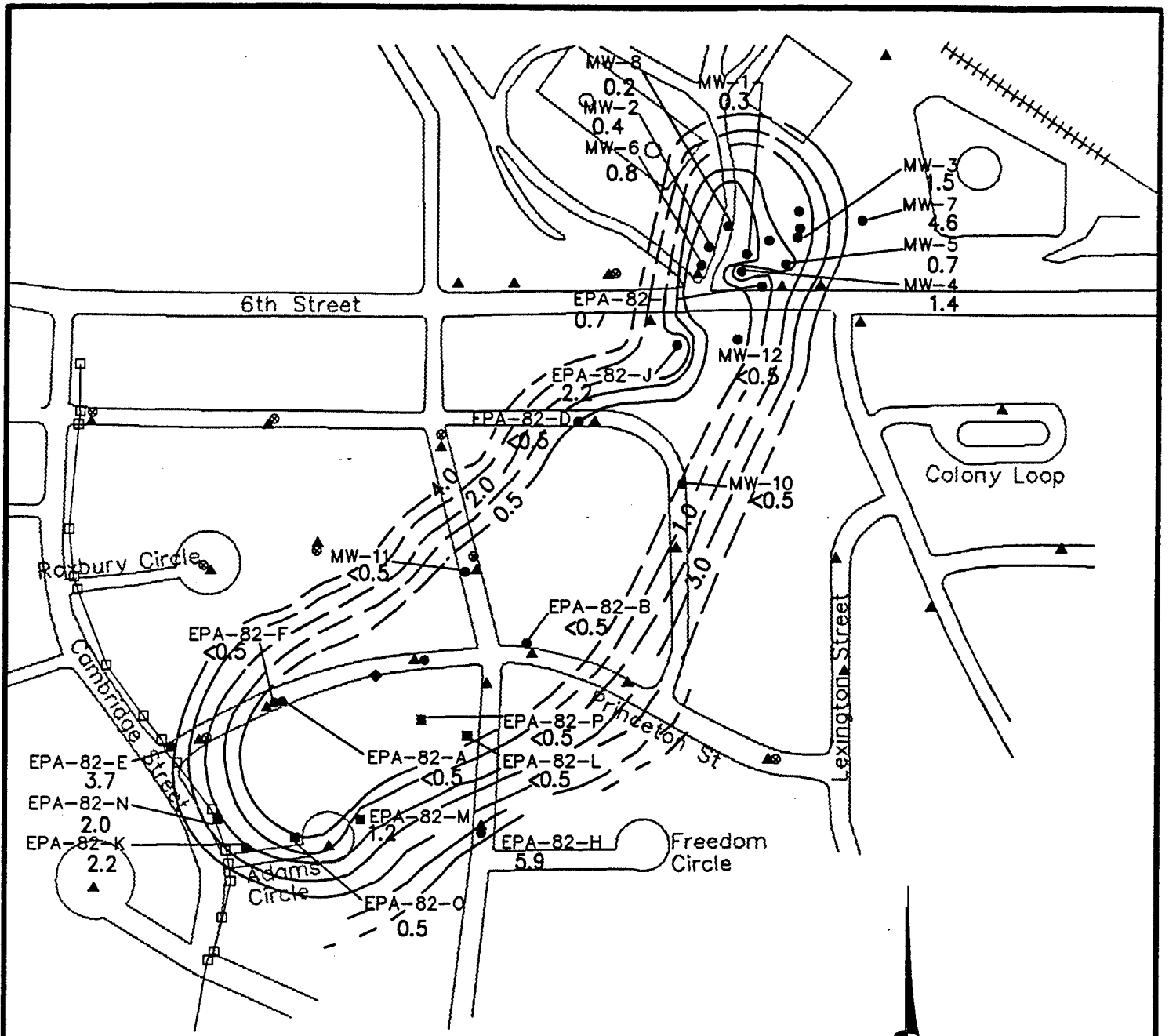

LEGEND

- ▲ CONE PENETROMETER TEST POINT/PIEZOMETER
- MW-11 ● MONITORING WELL LOCATION
- AUGUST 1993 GEOPROBE SAMPLING LOCATION
- STORM DRAIN SURVEY LOCATION
- JULY 1994 GEOPROBE SAMPLING LOCATION
- ◆ JULY 1994 SOIL BORING LOCATION

— 1.0 — LINE OF EQUAL DISSOLVED OXYGEN CONCENTRATION (mg/L) (DASHED WHERE INFERRED)

CONTOUR INTERVAL = VARIABLE



FIGURE 4.7
DISSOLVED OXYGEN ISOPLETH
FOR GROUNDWATER
JULY 1994

UST Site 870
 Intrinsic Remediation EE/CA
 Hill Air Force Base, Utah

PARSONS
ENGINEERING SCIENCE, INC.

Denver, Colorado

Based on these stoichiometric relationships, 1.03 mg of oxygen are required to mineralize 1 mg of benzene. Similar calculations can be made for toluene, ethylbenzene, and the xylenes. Based on this, approximately 0.97 mg of BTEX is mineralized to carbon dioxide and water for every 1.0 mg of DO consumed. With a background DO concentration of approximately 6 mg/L, the shallow ground water at this site has the capacity to assimilate 5.8 mg/L (5,800 µg/L) of total BTEX if microbial cell mass production is taken into account.

4.3.2.2 Nitrate/Nitrite

Concentrations of nitrate + nitrite (as N) were measured at Geoprobe® locations and monitoring points/wells in August 1993, November 1993, December 1993/January 1994, and July 1994. In addition, ground water samples were collected and analyzed for ionic nitrate and nitrite in December 1993/January 1994. Table 4.5 summarizes measured nitrate and nitrite concentrations. Figure 4.8 is an isopleth map showing the distribution of nitrate + nitrite (as N) in ground water in August 1993. Figure 4.9 is an isopleth map showing the distribution of nitrate + nitrite (as N) in ground water in July 1994. These figures include data collected from monitoring wells in the source area north of Sixth Street in December 1993/January 1994. These wells cover a small area and these data represent the only data available for this area. Comparison of Figures 4.4 and 4.8 and Figures 4.5 and 4.9, shows graphically that areas with elevated total BTEX concentrations have depleted nitrate + nitrite concentrations. Comparison of Figures 4.6 and 4.8 and Figures 4.7 and 4.9, shows graphically that areas with depleted DO concentrations have depleted nitrate + nitrite concentrations. These relationships provide strong evidence that anaerobic biodegradation of the BTEX compounds is occurring at the site through the microbially mediated process of denitrification.

In the absence of microbial cell production, the biodegradation of benzene to carbon dioxide and water is given by:

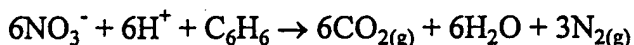

Based on this relationship, 6 moles of nitrate are required to mineralize 1 mole of benzene. On a mass basis, the ratio of nitrate to benzene is given by:

Molecular weights:	Benzene	6(12) + 6(1) = 78 gm/mole
	Nitrate	6(62) = 372 gm/mole

$$\text{Mass ratio of nitrate to benzene} = 372/78 = 4.77:1$$

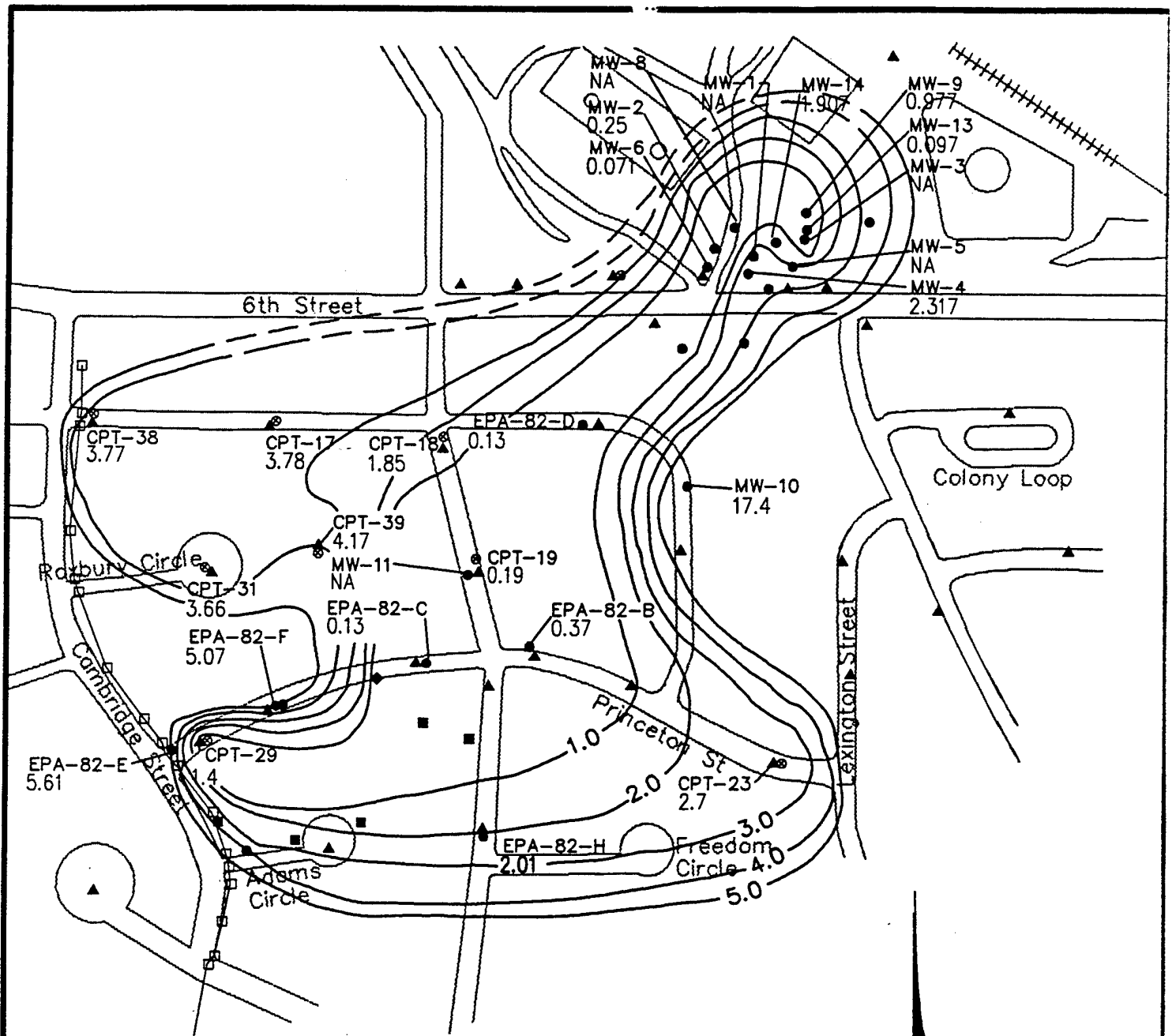

LEGEND

- CPT-26 ▲ CONE PENETROMETER TEST POINT/
PIEZOMETER
- MW-11 ● MONITORING WELL LOCATION
- AUGUST 1993 GEOPROBE SAMPLING
LOCATION
- STORM DRAIN SURVEY LOCATION
- EPA-82-M ■ JULY 1994 GEOPROBE SAMPLING
LOCATION
- EPA-82-KK ◆ JULY 1994 SOIL BORING LOCATION
- 3 — LINE OF EQUAL NITRATE AND
NITRITE CONCENTRATION (mg/L)
(AUGUST 1993, DECEMBER
1993 THROUGH JANUARY 1994)
(DASHED WHERE INFERRED)

CONTOUR INTERVAL = 1 mg/L

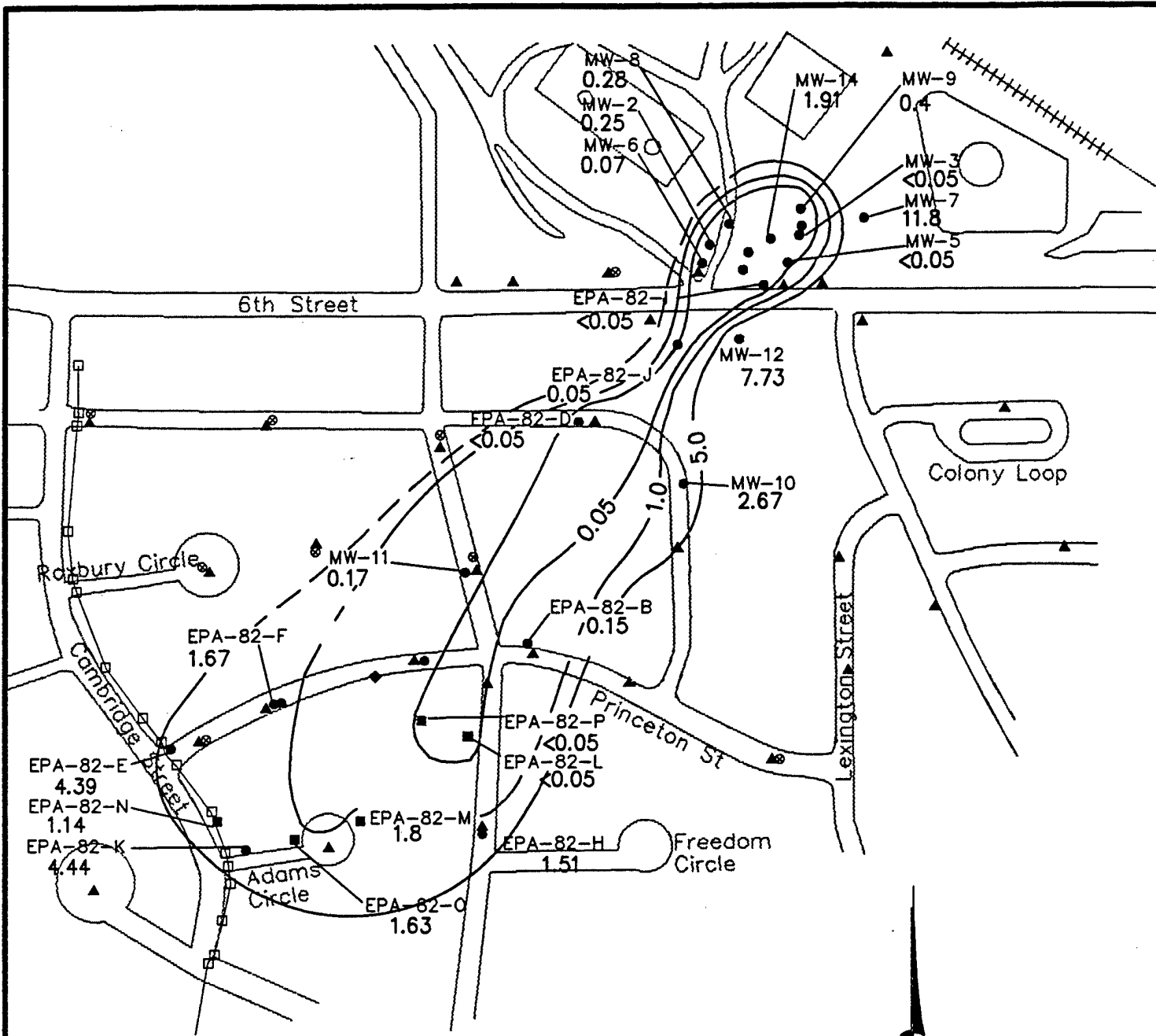

FIGURE 4.8
NITRATE + NITRITE
ISOPLETH FOR GROUNDWATER
AUGUST 1993

UST Site 870
Intrinsic Remediation EE/CA
Hill Air Force Base, Utah

PARSONS
ENGINEERING SCIENCE, INC.

Denver, Colorado



LEGEND

- ▲ CONE PENETROMETER TEST POINT/PIEZOMETER
- MW-11 ● MONITORING WELL LOCATION
- ⊙ AUGUST 1993 GEOPROBE SAMPLING LOCATION
- STORM DRAIN SURVEY LOCATION
- JULY 1994 GEOPROBE SAMPLING LOCATION
- ◆ JULY 1994 SOIL BORING LOCATION

— 1.0 — LINE OF EQUAL NITRATE + NITRITE CONCENTRATION (mg/L) (DASHED WHERE INFERRED)

CONTOUR INTERVAL = VARIABLE



FIGURE 4.9
NITRATE + NITRITE ISOPLETH
FOR GROUNDWATER
JULY 1994

UST Site 870
 Intrinsic Remediation EE/CA
 Hill Air Force Base, Utah

PARSONS
ENGINEERING SCIENCE, INC.

Denver, Colorado

In the absence of microbial cell production, 4.77 mg of nitrate are required to completely mineralize 1 mg of benzene. Similar calculations can be completed for toluene (4.85 mg nitrate to 1 mg toluene), ethylbenzene (4.92 mg nitrate to 1 mg ethylbenzene), and the xylenes (4.92 mg nitrate to 1 mg xylene). The average mass ratio of nitrate consumed to total BTEX degraded is 4.9:1. This means that approximately 0.21 mg of BTEX is mineralized for every 1.0 mg of nitrate consumed. With a background nitrate concentration of approximately 17 mg/L, the shallow ground water at this site has the capacity to assimilate 3.57 mg/L (3,570 µg/L) of total BTEX during denitrification. This is a very conservative estimate of the assimilative capacity of nitrate because microbial cell mass production has not been taken into account by the stoichiometry shown above (see Section 4.3.2.1).

4.3.2.3 Ferrous Iron

Ferrous iron concentrations were measured at Geoprobe[®] locations and monitoring points/wells in August 1993, November 1993, December 1993/January 1994, and July 1994. Table 4.5 summarizes ferrous iron concentrations. Figure 4.10 is an isopleth map showing the distribution of ferrous iron in ground water in August 1993. Figure 4.11 is an isopleth map showing the distribution of ferrous iron in ground water in July 1994. These figures include data collected from monitoring wells in the source area north of Sixth Street in December 1993/January 1994. These wells cover a small area and these data represent the only data available for this area. Comparison of Figures 4.4 and 4.10 and Figures 4.5 and 4.11 shows graphically that areas with elevated total BTEX concentrations have elevated ferrous iron concentrations. This is an indication that ferric iron is potentially being reduced to ferrous iron during biodegradation of BTEX compounds. However, it is possible that sulfate reduction at the site is reducing the redox potential of the ground water to sufficiently low levels to cause the dissolution of iron-bearing minerals in the shallow saturated soils at the site, thus elevating ferrous iron concentrations through non-biological processes. The highest measured ferrous iron concentration was 50.5 mg/L at monitoring well MW-02. Background levels of ferrous iron are at or below 0.05 mg/L, as measured at wells located outside of known BTEX contamination depicted on Figures 4.4 and 4.5.

The following equations describe the overall stoichiometry of benzene biodegradation by iron reduction through microbial biodegradation. In the absence of microbial cell production, the biodegradation of benzene is given by:

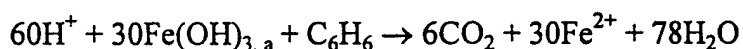

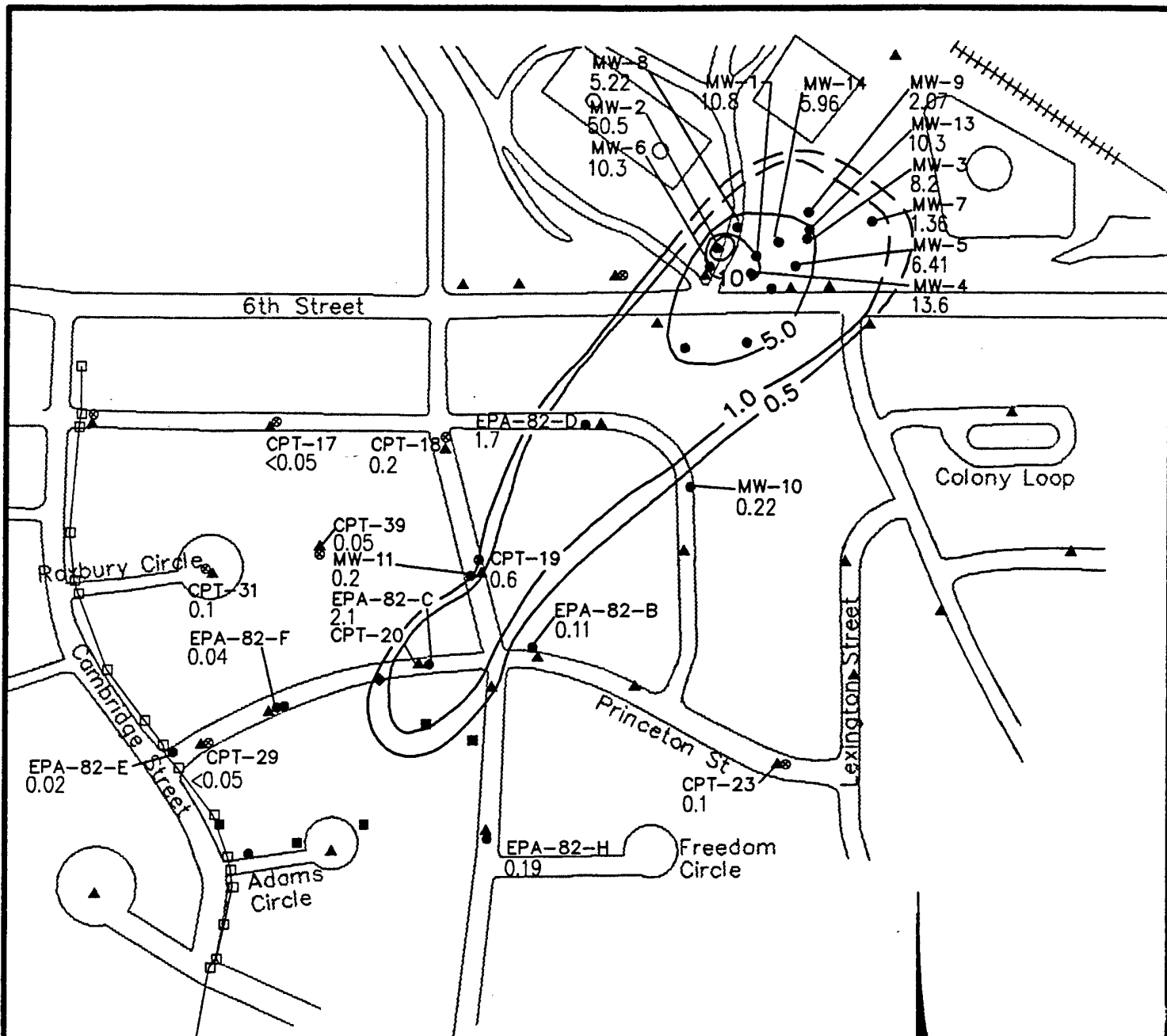

LEGEND

- CPT-26 ▲ CONE PENETROMETER TEST POINT/PIEZOMETER
- MW-11 ● MONITORING WELL LOCATION
- ⊙ AUGUST 1993 GEOPROBE SAMPLING LOCATION
- STORM DRAIN SURVEY LOCATION
- EPA-82-M ■ JULY 1994 GEOPROBE SAMPLING LOCATION
- EPA-82-KK ◆ JULY 1994 SOIL BORING LOCATION
- 0.20— LINE OF EQUAL IRON CONCENTRATION (mg/L) (AUGUST 1993, DECEMBER 1993 THROUGH JANUARY 1994) (DASHED WHERE INFERRED)

CONTOUR INTERVAL = VARIABLE

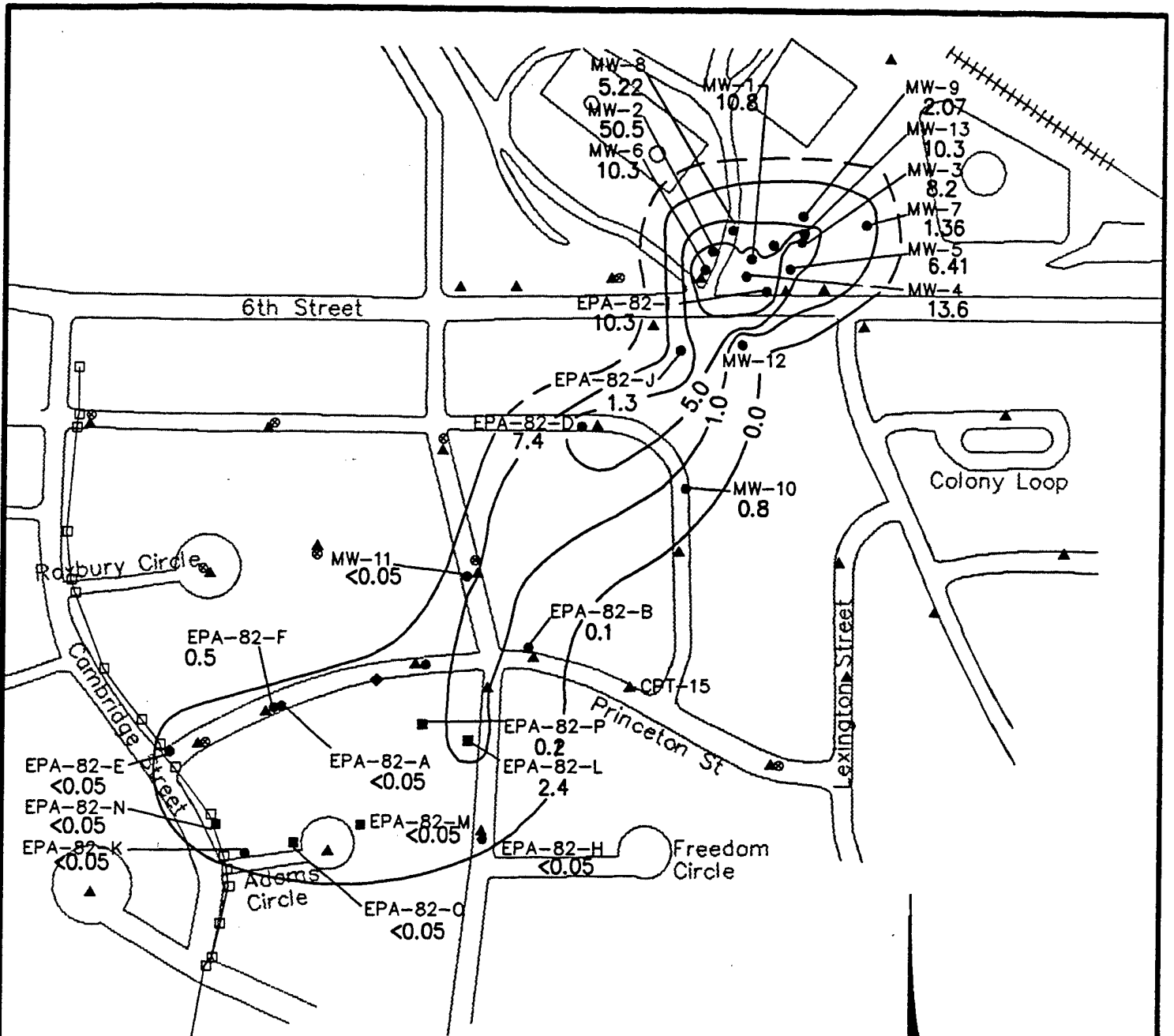

FIGURE 4.10
FERROUS IRON ISOPLETH
FOR GROUNDWATER
AUGUST 1993

UST Site 870
 Intrinsic Remediation EE/CA
 Hill Air Force Base, Utah

PARSONS
ENGINEERING SCIENCE, INC.

Denver, Colorado



LEGEND

- CPT-26 ▲ CONE PENETROMETER TEST POINT/
PIEZOMETER
- MW-11 ● MONITORING WELL LOCATION
- AUGUST 1993 GEOPROBE SAMPLING
LOCATION
- STORM DRAIN SURVEY LOCATION
- EPA-82-M ■ JULY 1994 GEOPROBE SAMPLING
LOCATION
- EPA-82-KK ◆ JULY 1994 SOIL BORING LOCATION
- 1.0 — LINE OF EQUAL FERROUS IRON
CONCENTRATION (mg/L)
(DASHED WHERE INFERRED)

CONTOUR INTERVAL = VARIABLE



FIGURE 4.11
FERROUS IRON ISOPLETH
FOR GROUNDWATER
JULY 1994

UST Site 870
Intrinsic Remediation EE/CA
Hill Air Force Base, Utah

PARSONS
ENGINEERING SCIENCE, INC.

Denver, Colorado

Therefore, 30 moles of $\text{Fe}(\text{OH})_3$ are required to mineralize 1 mole of benzene. On a mass basis, the ratio of $\text{Fe}(\text{OH})_3$ to benzene is given by:

Molecular weights:	Benzene	$6(12) + 6(1) = 78$ gm/mole
	$\text{Fe}(\text{OH})_3$	$30(106.85) = 3205$ gm/mole

$$\text{Mass ratio of } \text{Fe}(\text{OH})_3 \text{ to benzene} = 3205.41/78 = 41.1:1$$

Therefore, in the absence of microbial cell production, 41.1 mg of $\text{Fe}(\text{OH})_3$ are required to completely mineralize 1 mg of benzene. Alternatively, the mass ratio of ferrous iron produced during respiration to benzene degraded can be calculated and is given by:

Molecular weights:	Benzene	$6(12) + 6(1) = 78$ gm/mole
	Fe^{2+}	$30(55.85) = 1675.5$ gm/mole

$$\text{Mass ratio of } \text{Fe}^{2+} \text{ to benzene} = 1675.5/78 = 21.5:1$$

Therefore, 21.5 mg of Fe^{2+} are produced during biodegradation of 1 mg of benzene. Similar calculations can be completed for toluene (21.86 mg of Fe^{2+} produced during biodegradation of 1 mg of toluene), ethylbenzene (22.0 mg of Fe^{2+} produced during biodegradation of 1 mg of ethylbenzene), and the xylenes (22.0 mg of Fe^{2+} produced during biodegradation of 1 mg of xylene). The average mass ratio of Fe^{2+} produced during total BTEX biodegradation is thus 21.8:1. This means that approximately 1 mg of BTEX is mineralized for every 21.8 mg of Fe^{2+} produced. The highest measured Fe^{2+} concentration was 50.5 mg/L. This suggests that the shallow ground water at this site has the capacity to assimilate 2.3 mg/L (2,300 $\mu\text{g/L}$) of total BTEX during iron reduction. Again, this is a very conservative estimate of the assimilative capacity of iron because microbial cell mass production has not been taken into account by the stoichiometry shown above (see Section 4.3.2.1). In addition, this calculation is based on observed ferrous iron concentrations and not on the amount of ferric hydroxide available in the aquifer. Therefore, iron assimilative capacity could be much higher.

4.3.2.4 Sulfate

Sulfate concentrations were measured at Geoprobe[®] locations and monitoring points/wells in August 1993, November 1993, December 1993/January 1994, and July 1994. Table 4.5 summarizes measured sulfate concentrations. Figure 4.12 is a map showing sulfate concentrations in ground water in August 1993. There does not appear to be any clear trend between BTEX and sulfate concentrations downgradient of the source (compare Figure 4.12 to Figure 4.5) and near the leading edge of BTEX contamination in August 1993. However,

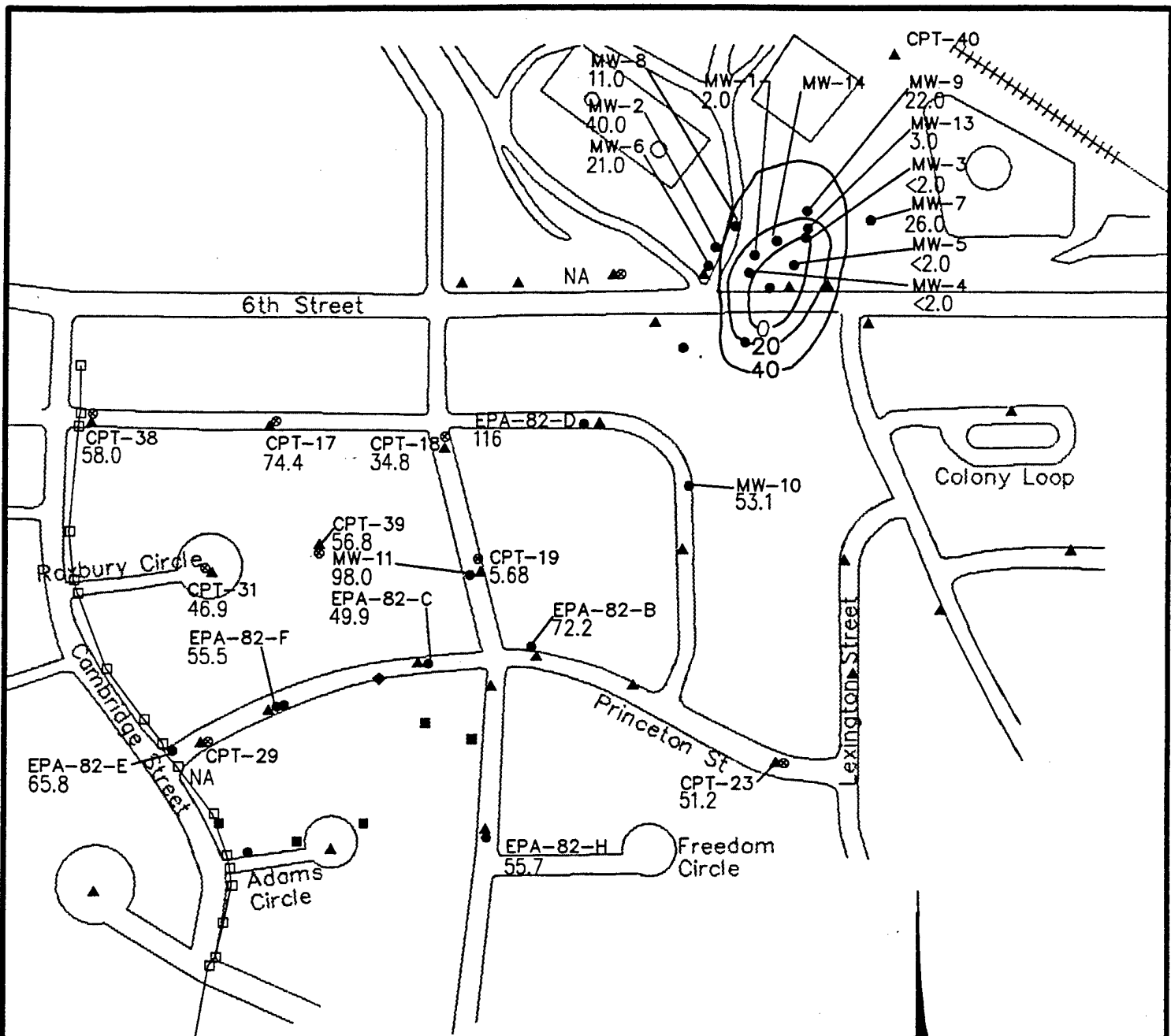

LEGEND

- CPT-26 ▲ CONE PENETROMETER TEST POINT/
PIEZOMETER
- MW-11 ● MONITORING WELL LOCATION
- ⊙ AUGUST 1993 GEOPROBE SAMPLING
LOCATION
- STORM DRAIN SURVEY LOCATION
- EPA-82-M ■ JULY 1994 GEOPROBE SAMPLING
LOCATION
- EPA-82-KK ◆ JULY 1994 SOIL BORING LOCATION
- 100— LINE OF EQUAL SULFATE
CONCENTRATION (mg/L)
- CONTOUR INTERVAL = 20 mg/L



FIGURE 4.12
SULFATE ISOPLETH IN
GROUNDWATER
AUGUST 1993

UST Site 870
 Intrinsic Remediation EE/CA
 Hill Air Force Base, Utah

PARSONS
ENGINEERING SCIENCE, INC.
 Denver, Colorado

localized sulfate reductions are seen in the source area. Figure 4.13 is an isopleth map showing the distribution of sulfate in ground water in July 1994. This figure includes data collected from monitoring wells in the source area north of Sixth Street in December 1993/January 1994. These wells cover a small area and these data represent the only data available for this area. Comparison of Figures 4.5 and 4.13, shows graphically that by July 1994, areas with elevated total BTEX concentrations had depleted sulfate concentrations. This is a strong indication that the rate of anaerobic biodegradation of the BTEX compounds through sulfanogenesis increased from 1993 to 1994. It is possible that the redox reactions required for sulfate reduction to proceed in the ground water environment in 1993 were not microbially mediated, and that the depletion of other available electron acceptors by 1994 likely increased the importance of sulfate reducing processes.

The following equations describe the overall stoichiometry of BTEX oxidation by sulfate reduction caused by anaerobic microbial biodegradation. In the absence of microbial cell production, the biodegradation of benzene is given by:

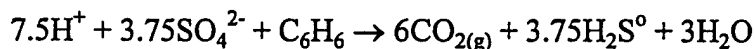

Therefore, 3.75 moles of sulfate are required to mineralize 1 mole of benzene. On a mass basis, the ratio of sulfate to benzene is given by:

Molecular weights:	Benzene	$6(12) + 6(1) = 78$ gm/mole
	Sulfate	$3.75(96) = 360$ gm/mole

$$\text{Mass ratio of sulfate to benzene} = 360/78 = 4.6:1$$

Therefore, in the absence of microbial cell production, 4.6 mg of sulfate are required to completely mineralize 1 mg of benzene. Similar calculations can be completed for toluene (4.7 mg sulfate to 1 mg toluene), ethylbenzene (4.75 mg sulfate to 1 mg ethylbenzene), and the xylenes (4.75 mg sulfate to 1 mg xylene). The average mass ratio of sulfate to total BTEX is thus 4.7:1. This means that approximately 0.21 mg of BTEX is mineralized for every 1.0 mg of sulfate consumed. Assuming a background sulfate concentration of 100 mg/L, the shallow ground water at this site has the capacity to assimilate 21 mg/L (21,000 µg/L) of total BTEX during sulfanogenesis. Again, this is a very conservative estimate of the assimilative capacity of sulfate because microbial cell mass production has not been taken into account by the stoichiometry shown above (see Section 4.3.2.1).

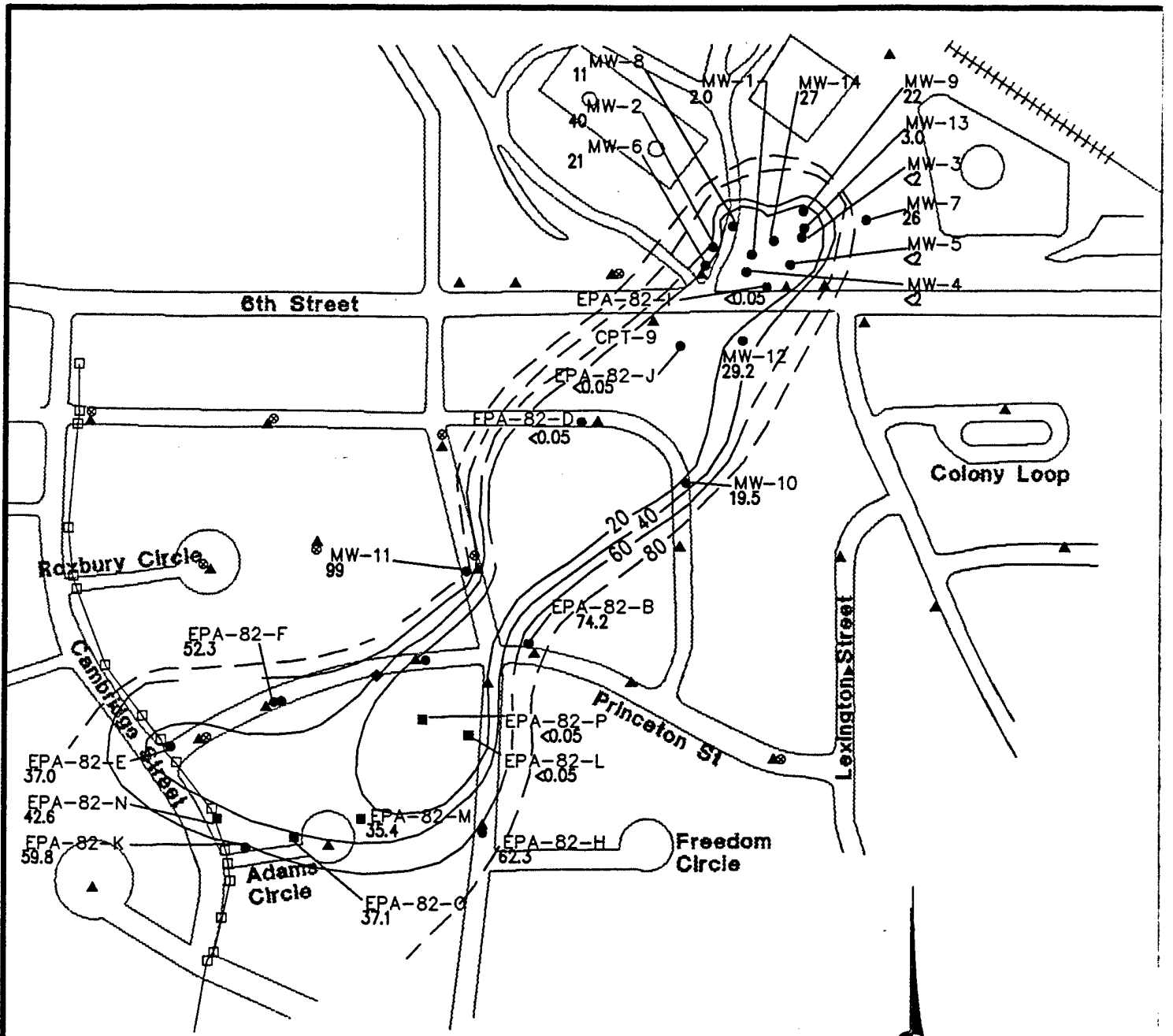

LEGEND

- CPT-26 ▲ CONE PENETROMETER TEST POINT/
PIEZOMETER
 - MW-11 ● MONITORING WELL LOCATION
 - AUGUST 1993 GEOPROBE SAMPLING
LOCATION
 - STORM DRAIN SURVEY LOCATION
 - EPA-82-M ■ JULY 1994 GEOPROBE SAMPLING
LOCATION
 - EPA-82-KK ◆ JULY 1994 SOIL BORING LOCATION
11.0
SULFATE CONCENTRATION (mg/L)
 - 20.0 — LINE OF EQUAL SULFATE
CONCENTRATION (mg/L)
(DASHED WHERE INFERRED)
- CONTOUR INTERVAL = 20 mg/L



FIGURE 4.13

**SULFATE ISOPLETH
FOR GROUND WATER
JULY 1994**

UST Site 870
Intrinsic Remediation EE/CA
Hill Air Force Base, Utah

**PARSONS
ENGINEERING SCIENCE, INC.**

Denver, Colorado

4.3.1.5 Methane

Methane concentrations were measured at Geoprobe® locations and monitoring points/wells in August 1993, November 1993, and December 1993/January 1994. Table 4.5 summarizes methane concentrations. Background levels of methane appear to be below 0.001 mg/L at wells located outside areas with known BTEX contamination. The highest methane concentration observed at the site was 2.04 mg/L in MW-5. Figure 4.14 is an isopleth map showing the distribution of methane in ground water in August 1993. Figure 4.15 is an isopleth map showing the distribution of methane in ground water in July 1994. These figures include data collected from monitoring wells in the source area north of Sixth Street in December 1993/January 1994. These wells cover a small area and these data represent the only data available for this area. Comparison of Figures 4.4 and 4.14 and Figures 4.5 and 4.15, shows graphically that areas with elevated total BTEX concentrations have elevated methane concentrations. This is a strong indication that anaerobic biodegradation of the BTEX compounds is occurring at the site through the microbially mediated process of methanogenesis.

Comparison of Figures 4.14 and 4.15 suggests that methanogenesis, like sulfanogenesis, may have become a more important BTEX-degradation mechanism between August 1993 and July 1994. This is consistent with other electron acceptor data found at the site with the area having elevated methane concentrations being confined to areas with depleted DO, nitrate, and sulfate concentrations and elevated ferrous iron concentrations (compare Figures 4.6 through 4.15). In addition, comparison of Figures 4.14 and 4.15 suggests that methanogenesis is becoming a more important BTEX degradation mechanism as the BTEX plume matures.

The following equations describe the overall stoichiometry of benzene biodegradation by methanogenesis. In the absence of microbial cell production, the biodegradation of benzene is given by:

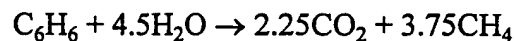

The mass ratio of methane produced during respiration to benzene degraded can be calculated and is given by:

Molecular weights:	Benzene	$6(12) + 6(1) = 78$ gm/mole
	Methane	$3.75(16) = 60$ gm/mole

$$\text{Mass ratio of methane to benzene} = 60/78 = 0.77:1$$

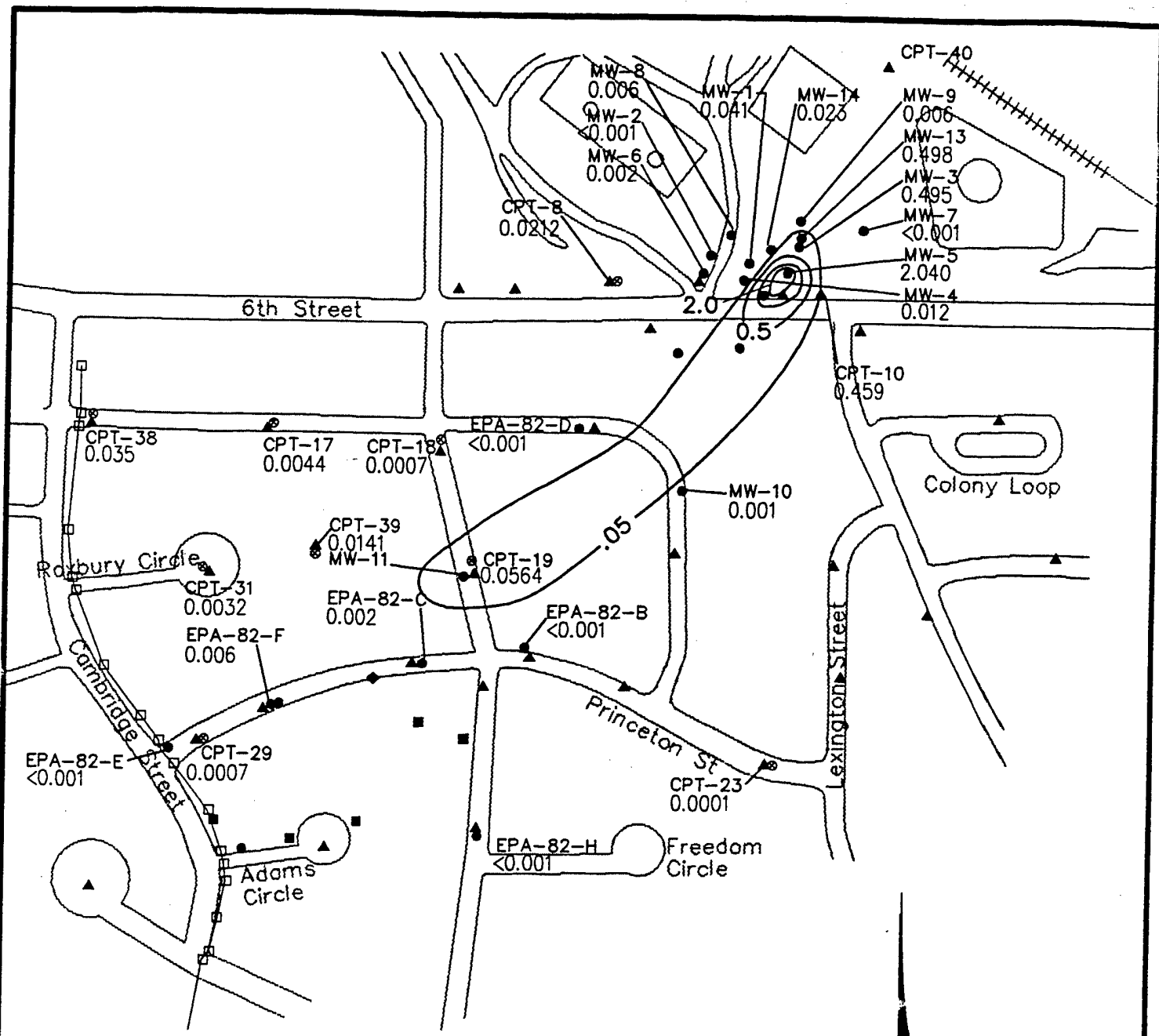

LEGEND

- CPT-26 ▲ CONE PENETROMETER TEST POINT/PIEZOMETER
- MW-11 ● MONITORING WELL LOCATION
- AUGUST 1993 GEOPROBE SAMPLING LOCATION
- STORM DRAIN SURVEY LOCATION
- EPA-82-M ■ JULY 1994 GEOPROBE SAMPLING LOCATION
- EPA-82-KK ◆ JULY 1994 SOIL BORING LOCATION
- 0.01 — LINE OF EQUAL METHANE CONCENTRATION (mg/L) (AUGUST 1993, DECEMBER 1993 THROUGH JANUARY 1994)

CONTOUR INTERVAL = VARIABLE

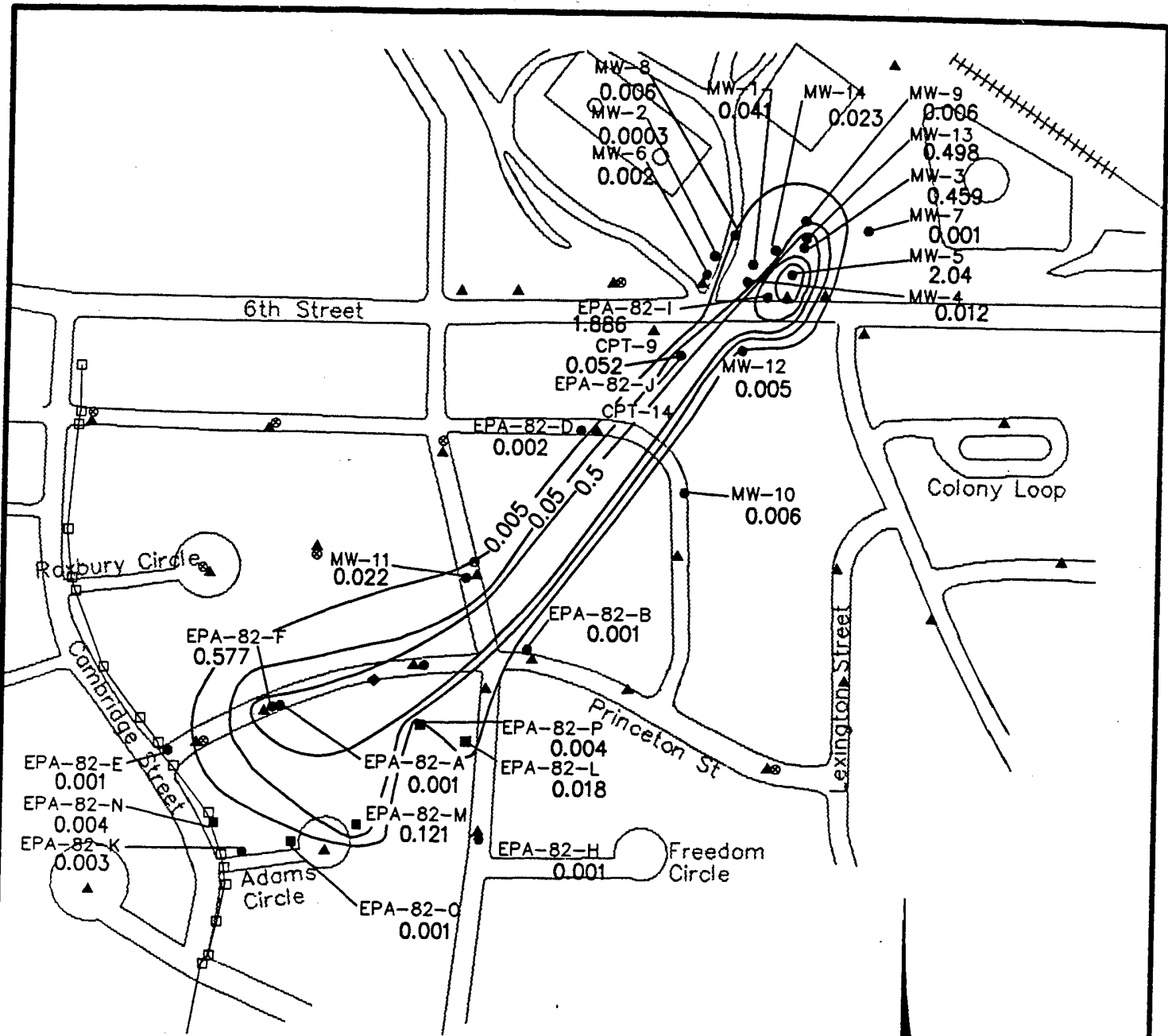

FIGURE 4.14
METHANE ISOPLETH FOR
GROUNDWATER
AUGUST 1993

UST Site 870
 Intrinsic Remediation EE/CA
 Hill Air Force Base, Utah

PARSONS
ENGINEERING SCIENCE, INC.

Denver, Colorado



LEGEND

- CPT-26 ▲ CONE PENETROMETER TEST POINT/PIEZOMETER
- MW-11 ● MONITORING WELL LOCATION
- ⊙ AUGUST 1993 GEOPROBE SAMPLING LOCATION
- STORM DRAIN SURVEY LOCATION
- EPA-82-M ■ JULY 1994 GEOPROBE SAMPLING LOCATION
- EPA-82-KK ◆ JULY 1994 SOIL BORING LOCATION
- 0.05 — LINE OF EQUAL METHANE CONCENTRATION (mg/L)

CONTOUR INTERVAL = VARIABLE



FIGURE 4.15
METHANE ISOPLETH
FOR GROUNDWATER
JULY 1994

UST Site 870
 Intrinsic Remediation EE/CA
 Hill Air Force Base, Utah

PARSONS
ENGINEERING SCIENCE, INC.
 Denver, Colorado

Therefore, 0.77 mg of methane is produced during biodegradation of 1 mg of benzene. Similar calculations can be completed for toluene (0.78 mg of methane produced during biodegradation of 1 mg of toluene), ethylbenzene (0.79 mg of methane produced during biodegradation of 1 mg of ethylbenzene), and the xylenes (0.79 mg of methane produced during biodegradation of 1 mg of xylene). The average mass ratio of methane produced during total BTEX biodegradation is thus 0.78:1. This means that approximately 1 mg of BTEX is mineralized for every 0.78 mg of methane produced. The highest measured methane concentration was 2.04 mg/L. This suggests that the shallow ground water at this site has the capacity to assimilate 2.6 mg/L (2,600 µg/L) of total BTEX during methanogenesis. Again, this is a very conservative estimate of the assimilative capacity of methanogenesis because microbial cell mass production is not taken into account by the stoichiometry shown above (see Section 4.3.2.1). In addition, these calculations are based on observed methane concentrations and not on the amount of carbon dioxide available in the aquifer. Therefore, methanogenic assimilative capacity could be much higher.

4.3.2.6 Reduction/Oxidation Potential

Redox potentials were measured at Geoprobe[®] locations and monitoring points/wells in August 1993, November 1993, December 1993/January 1994, and July 1994. Redox potential is a measure of the relative tendency of a solution to accept or transfer electrons. The redox potential of a groundwater system depends on which electron acceptor is being reduced by microbes during BTEX oxidation. The redox potential at UST Site 870 ranges from 274 millivolts (mV) to -137 mV. Table 4.5 summarizes available redox potential data. Figures 4.16 and 4.17 graphically illustrate the distribution of redox potentials in August 1993 and July 1994, respectively. Redox potential is decreased to a low value of -190 mV in MW-10. Areas at the site with low redox potentials coincide with areas with high BTEX contamination, low DO, nitrate, and sulfate concentrations, and elevated ferrous iron and methane concentrations (compare Figures 4.4 through 4.17). This suggests that dissolved BTEX at the site may be subjected to a variety of biodegradation processes including aerobic respiration, denitrification, iron reduction, sulfanogenesis, and methanogenesis.

4.3.2.7 Alkalinity

Total alkalinity (as CaCO₃) was measured at Geoprobe[®] locations and monitoring points/wells in August 1993, November 1993, December 1993/January 1994, and July 1994.

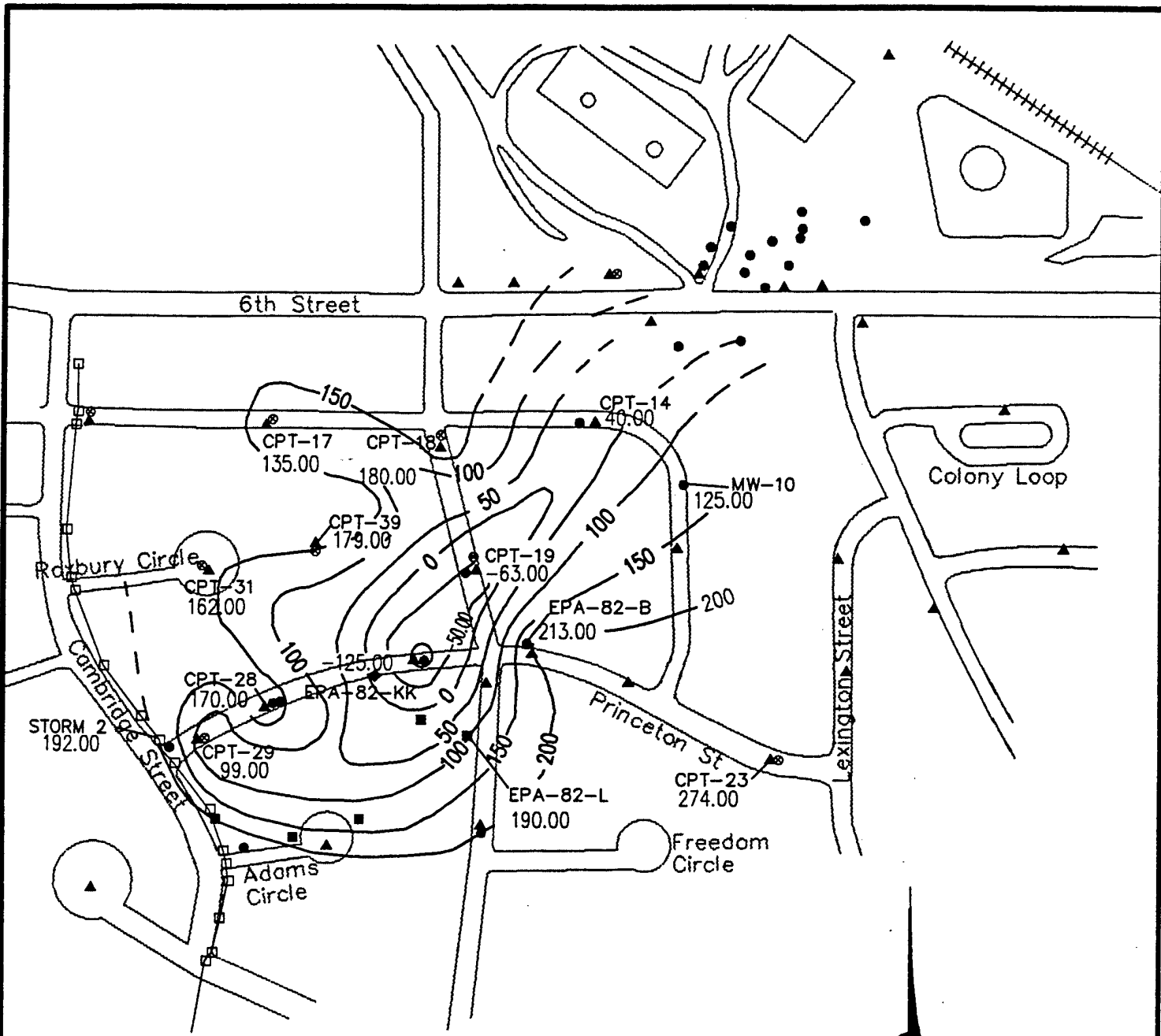

LEGEND

- CPT-26 ▲ CONE PENETROMETER TEST POINT/
PIEZOMETER
- MW-11 ● MONITORING WELL LOCATION
- AUGUST 1993 GEOPROBE SAMPLING
LOCATION
- STORM DRAIN SURVEY LOCATION
- EPA-82-M ■ JULY 1994 GEOPROBE SAMPLING
LOCATION
- EPA-82-KK ◆ JULY 1994 SOIL BORING LOCATION
- 100— LINE OF EQUAL
OXIDATION-REDUCTION
POTENTIAL (mV)



FIGURE 4.16
**REDUCTION/OXIDATION
 POTENTIAL MAP
 AUGUST 1993**

UST Site 870
 Intrinsic Remediation EE/CA
 Hill Air Force Base, Utah

**PARSONS
 ENGINEERING SCIENCE, INC.**
 Denver, Colorado

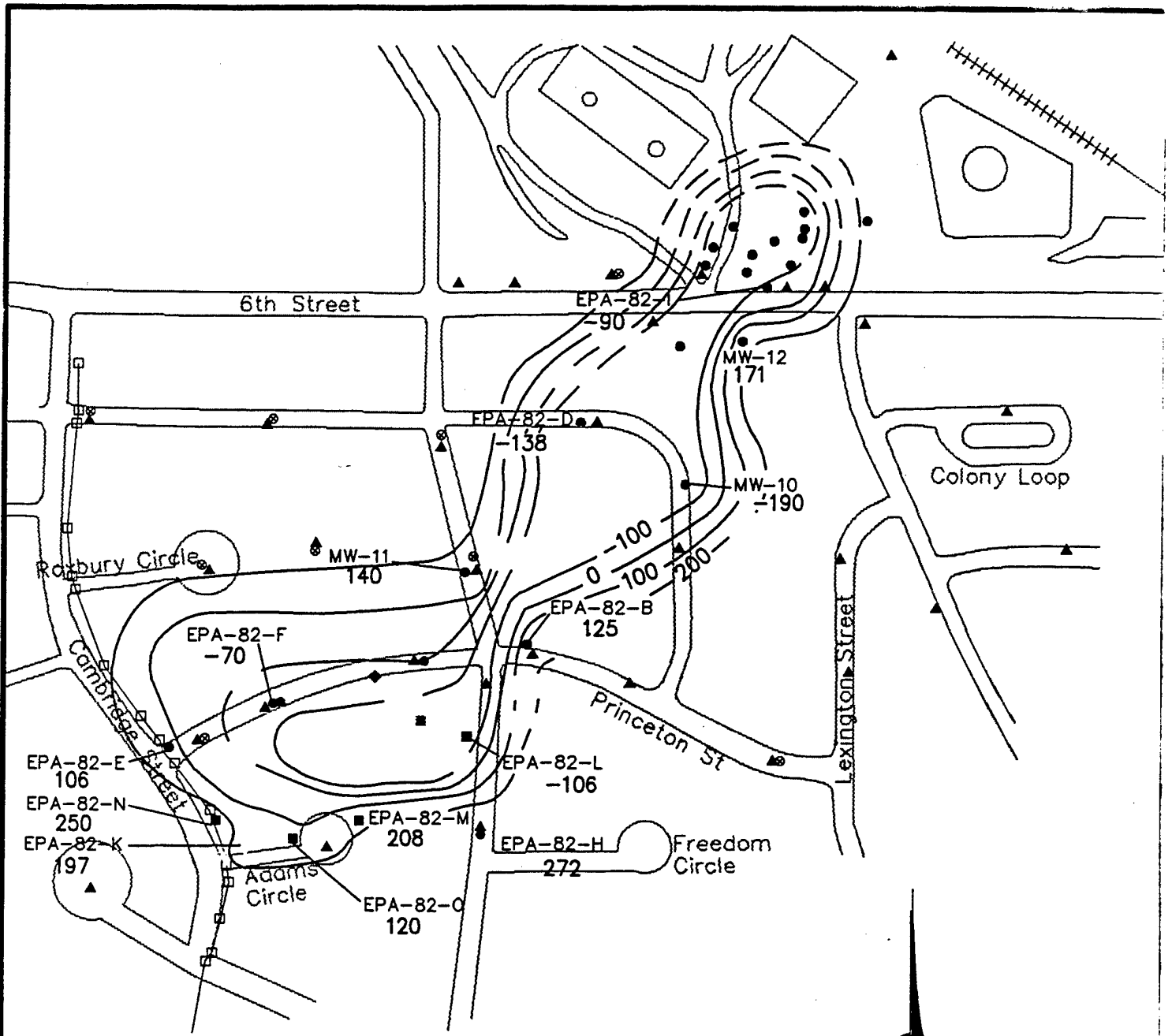

LEGEND

- CPT-26 ▲ CONE PENETROMETER TEST POINT/
PIEZOMETER
- MW-11 ● MONITORING WELL LOCATION
- AUGUST 1993 GEOPROBE SAMPLING
LOCATION
- STORM DRAIN SURVEY LOCATION
- EPA-82-M ■ JULY 1994 GEOPROBE SAMPLING
LOCATION
- EPA-82-KK ◆ JULY 1994 SOIL BORING LOCATION
- 100— LINE OF EQUAL REDOX POTENTIAL (mV)
(DASHED WHERE INFERRED)

NOTE: UNLABELED WELL POINTS WERE NOT SAMPLED



FIGURE 4.17
REDUCTION/OXIDATION
POTENTIAL MAP
JULY 1994

UST Site 870
Intrinsic Remediation EE/CA
Hill Air Force Base, Utah

PARSONS
ENGINEERING SCIENCE, INC.

Denver, Colorado

These measurements are summarized in Table 4.5. Alkalinity is a measure of a ground water's ability to buffer changes in pH caused by the addition of biologically generated acids. Total alkalinity at the site is fairly high, and varies from 959 mg/L at EPA-82-D to 349 mg/L at EPA-82-E. This amount of alkalinity should be sufficient to buffer potential changes in pH caused by biologically mediated BTEX oxidation reactions.

4.3.2.8 pH

The pH was measured at Geoprobe[®] locations and monitoring points/wells in August, 1993, November 1993, December 1993/January 1994, and July 1994. These measurements are summarized in Table 4.5. The pH of a solution is the negative logarithm of the hydrogen ion concentration $[H^+]$. Ground water pH at UST Site 870 ranges from slightly acidic (6.3) to slightly basic (8.3). The majority of ground water has a pH of between 7.1 and 7.4. This range of pH is optimal for BTEX-degrading microbes.

4.3.2.9 Temperature

Ground water temperature was measured at Geoprobe[®] locations and monitoring points/wells in August 1993, November 1993, December 1993/January 1994, and July 1994. Table 4.5 summarizes ground water temperature readings. Temperature affects the types and growth rates of bacteria that can be supported in the ground water environment. Temperatures in the shallow saturated zone vary from 12.9 degrees Celsius ($^{\circ}C$) to 25 $^{\circ}$.

4.3.3 Expressed Assimilative Capacity

The data presented in the preceding sections suggest that mineralization of BTEX compounds is occurring through the microbially mediated processes of aerobic respiration, denitrification, iron reduction, sulfanogenesis, and methanogenesis. Based on the stoichiometry presented in these sections, the expressed BTEX assimilative capacity of ground water at UST Site 870 is at least 31,370 $\mu\text{g/L}$ (Table 4.6). The calculations presented in these earlier sections are extremely conservative because they do not account for microbial cell mass production. In addition, the measured concentrations of ferrous iron and methane may not be the maximum achievable. The highest plausible dissolved-phase total BTEX concentration observed at the site was 26,576 $\mu\text{g/L}$ in monitoring well MW-03 in August 1992. The total BTEX concentration in this well in

December 1993/January 1994 was 9,466 µg/L. The highest total BTEX concentration observed in July 1994 was 21,475 µg/L.

Based on the calculations presented in the preceding sections, and on site observations, ground water at UST Site 870 has enough assimilative capacity to degrade dissolved-phase BTEX that partitions from the LNAPL plume into the ground water before the plume migrates 1,600 feet downgradient from the source area.

TABLE 4.6
EXPRESSED ASSIMILATIVE CAPACITY OF SITE GROUND WATER
UST SITE 870 INTRINSIC REMEDIATION EE/CA
HILL AFB, UTAH

Electron Acceptor or Process	Expressed BTEX Assimilative Capacity (µg/L)
Dissolved Oxygen	1,900
Nitrate	3,570
Ferric Hydroxide	2,300
Sulfate	21,000
Methanogenesis	2,600
Expressed Assimilative Capacity	31,370
Highest observed Total BTEX Concentration	26,576

SECTION 5

GROUND WATER MODEL

5.1 GENERAL OVERVIEW AND MODEL DESCRIPTION

In order to estimate degradation rates of dissolved-phase BTEX compounds at UST Site 870, and to help predict the future migration of these compounds, Parsons ES modeled the fate and transport of the dissolved-phase BTEX plume. The modeling effort had three primary objectives: 1) to predict the future extent and concentration of the dissolved-phase contaminant plume by modeling the combined effects of advection, dispersion, sorption, and biodegradation; 2) to assess the possible risk to potential downgradient receptors; and 3) to provide technical support for the natural attenuation remedial option at post-modeling regulatory negotiations. The model was developed using site-specific data and conservative assumptions about governing physical and chemical processes. Because of the conservative nature of model input, the reduction in contaminant mass caused by natural attenuation is expected to exceed model predictions. This analysis is not intended to represent a baseline assessment of potential risks posed by site contamination.

The Bioplume II computer model was used to estimate the potential for dissolved-phase BTEX migration and degradation by naturally-occurring mechanisms operating at UST Site 870. The Bioplume II model incorporates advection, dispersion, sorption, and biodegradation to simulate BTEX plume migration and degradation. The model is based upon the US Geological Survey Method of Characteristics (USGS MOC) two-dimensional (2-D) solute transport model of Konikow and Bredehoeft (1978). The model was modified by researchers at Rice University to include a biodegradation component that is activated by a superimposed DO plume. Based on the work of Borden and Bedient (1986), the model assumes a reaction between the DO and BTEX that is instantaneous relative to the advective ground water velocity. Bioplume II solves the USGS 2-D solute transport equation twice, once for hydrocarbon concentrations in the aquifer and once for a DO plume. The two plumes are combined using superposition at every particle move to simulate the instantaneous, biologically-mediated, reaction between hydrocarbons and oxygen. In recent years it has

become apparent that anaerobic processes such as nitrate reduction (denitrification), iron reduction, sulfate reduction (sulfanogenesis), and methanogenesis can be important BTEX degradation mechanisms (Grbic'-Galic' and Vogel, 1987; Lovely *et al.*, 1989; Grbic'-Galic', 1990; Hutchins, 1991; Beller *et al.*, 1992; Edwards *et al.*, 1992; Edwards and Grbic'-Galic', 1992). As with DO, the reaction between nitrate and BTEX can be assumed to be instantaneous relative to the ground water flow velocity (Wilson, 1994). The Bioplume II model does not allow direct input of nitrate concentrations. Because of this, nitrate concentrations were input as DO-equivalent concentrations. The use of nitrate in this manner allowed the Bioplume II model to more accurately simulate rates of biodegradation at the site. The use of nitrate as a model input parameter is discussed in Section 5.4.5. The following sections discuss in more detail the model setup, input parameters and assumptions, model calibration, and simulation results.

5.2 CONCEPTUAL MODEL DESIGN AND ASSUMPTIONS

Prior to developing a ground water model, it is important to determine if sufficient data are available to provide a reasonable estimate of aquifer hydraulic and geochemical conditions. In addition, it is important to ensure that any limiting assumptions can be justified. The most important assumption made when using the Bioplume II model is that oxygen-limited (and in this case, oxygen/nitrate-limited) biodegradation is occurring at the site. The Bioplume II model assumes that the limiting factors for biodegradation are: 1) the presence of an indigenous hydrocarbon degrading microbial population, and 2) sufficient background electron acceptor concentrations. Data presented in Sections 3 and 4 indicate that oxygen, nitrate, ferric hydroxide, sulfate, and carbon dioxide (methanogenesis) are all being used for aerobic and anaerobic biodegradation. To be conservative, only oxygen and nitrate are used as electron acceptors in the instantaneous reaction simulated by the Bioplume II model presented herein. To model biodegradation with DO and nitrate as electron acceptors, the isopleth maps for these compounds were superimposed and combined to form a "total" electron acceptor isopleth map. These data were then used for model input.

Based on the data presented in Section 3, the shallow saturated zone was conceptualized and modeled as a shallow unconfined aquifer comprised of medium-grained, moderately sorted sands (Figures 3.3 and 3.4.). With the exception of limited mobile LNAPL removal and bioventing in the spill area, contaminated soils at the site have not been remediated.

Additional mobile and residual LNAPL removal would further reduce the continuing source of dissolved-phase BTEX contamination at the site. Several model simulations were conducted; both with LNAPL as a continuing source and with the LNAPL removed through time. Because of the low residual-phase BTEX concentrations observed in soils outside of areas containing mobile LNAPL, it was assumed that these soils represent a minimal source of continuing BTEX contamination. The use of a two-dimensional model is appropriate at Site UST 870 because the saturated interval is thin (generally less than 3 feet) and a relatively impermeable clayey silt and silty clay confining layer directly underlies the saturated zone. In addition, vertical ground water gradients at the site are upward, as is common over much of the Great Salt Lake Basin.

5.4 MODEL INPUT

Input parameters used for this model are based on a review of existing site data and a review of the pertinent literature. Where site-specific data were not available, reasonable assumptions for the types of materials comprising the shallow saturated zone were made based on widely accepted literature values. Table 5.1 lists the input parameters used for the modeling effort. Appendix D contains gridded data used as model input. Model output is presented in Appendix E as a diskette in ASCII format. The following sections describe the Bioplume II model parameters that have the greatest influence on model predictions.

5.4.1 Grid Design

The maximum grid size for the Bioplume II model is limited to 20 columns by 30 rows. The dimension of each column and row can range from 0.1 to 999.9 feet. A 20- by 30-cell grid was used to model the Hill AFB site. Each grid cell was 110 feet long by 85 feet wide. The grid was oriented so that the longest cell dimension was parallel to the direction of ground water flow (Figure 5.1). The model grid covers an area of 5.6 million square feet, or approximately 129 acres.

Constant-head boundaries were established along the northeast and southwest perimeter of the model grid to simulate the southwestern flow of ground water observed at the site. These constant-head cells were placed at a sufficient distance from the BTEX plume to avoid potential boundary interferences. Injection cells were used to simulate the

TABLE 5.1
BIOPLUME II MODEL INPUT PARAMETERS
UST SITE 870 INTRINSIC REMEDIATION EE/CA
HILL AFB, UTAH

Parameter	Description	Calibrated Model Setup	Hill-A	Hill-B	Hill-C
NTIM	Max. number of time steps in a pumping period		15	2	2
NPMP	Number of Pumping Periods		1	25	12
NX	Number of nodes in the X direction		20	20	20
NY	Number of nodes in the Y direction		30	30	30
NPMAX	Maximum number of Particles $NPMAX=(NX-2)(NY-2)(NPTPND) + (Ne)(NPTPND) + 250$		5290	5290	5290
NPNT	Time step interval for printing data	1	1	1	1
NITP	Number of iteration parameters	7	7	7	7
NUMOBS	Number of observation points		5	5	5
ITMAX	Maximum allowable number of iterations in ADIP	200	200	200	200
NREC	Number of pumping or injection wells		20	0	0
NPTPND	Initial number of particles per node	9	9	9	9
NCODES	Number of node identification codes		2	2	2
NPNTMV	Particle movement interval (IMOV)	0	0	0	0
NPNTVL	Option for printing computed velocities	2	1	1	1
NPNTD	Option to print computed dispersion equation coefficients	2	1	1	1
NPDEL	Option to print computed changes in concentration	1	1	1	1
NPNCHV	Option to punch velocity data	0	0	0	0
NREACT	Option for biodegradation, retardation and decay	1	1	1	1
PINT	Pumping period (years)		15	1	1
TOL	Convergence criteria in ADIP	0.001	0.001	0.001	0.001
POROS	Effective porosity		0.25	0.25	0.25
BETA	Characteristic length (long. dispersivity; feet)		53.4	53.4	53.4
S	Storage Coefficient	0 (Steady-State)	0	0	0
TIMX	Time increment multiplier for transient flow		NA	NA	NA
TINIT	Size of initial time step (seconds)		NA	NA	NA
XDEL	Width of finite difference cell in the x direction (feet)		85	85	85
YDEL	Width of finite difference cell in the y direction (feet)		110	110	110
DLTRAT	Ratio of transverse to longitudinal dispersivity	0.1	0.1	0.1	0.1
CELDIS	Maximum cell distance per particle move	0.5	1	0.5	0.5
ANFCTR	Ratio of Tyy to Txx	1 (Isotropic)	1	1	1
DK	Distribution coefficient		.05451	.05451	.05451
RHOB	Bulk density of the solid (grams/cubic centimeter)		1.6	1.6	1.6
THALF	Half-life of the solute		0	0	0
DEC1	Anaerobic decay coefficient		0	0	0
DEC2	Reaeration coefficient (day ⁻¹)		.003	.003	.003

NA = Not Applicable

- LEGEND**
- CPT-25 ▲ CONE PENETROMETER TEST POINT/PIEZOMETER
 - MW-11 ● MONITORING WELL LOCATION
 - AUGUST 1993 GEOPROBE SAMPLING LOCATION
 - STORM DRAIN SURVEY LOCATION
 - EPA-82-M ■ JULY 1994 GEOPROBE SAMPLING LOCATION
 - EPA-82-KK ◆ JULY 1994 SOIL BORING LOCATION
 - EPA-82-R ○ JULY 1994 SOIL GAS SAMPLING LOCATION
 - HHHHHHHH RAILROAD TRACKS
 - X INJECTION CELL LOCATION

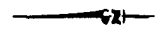
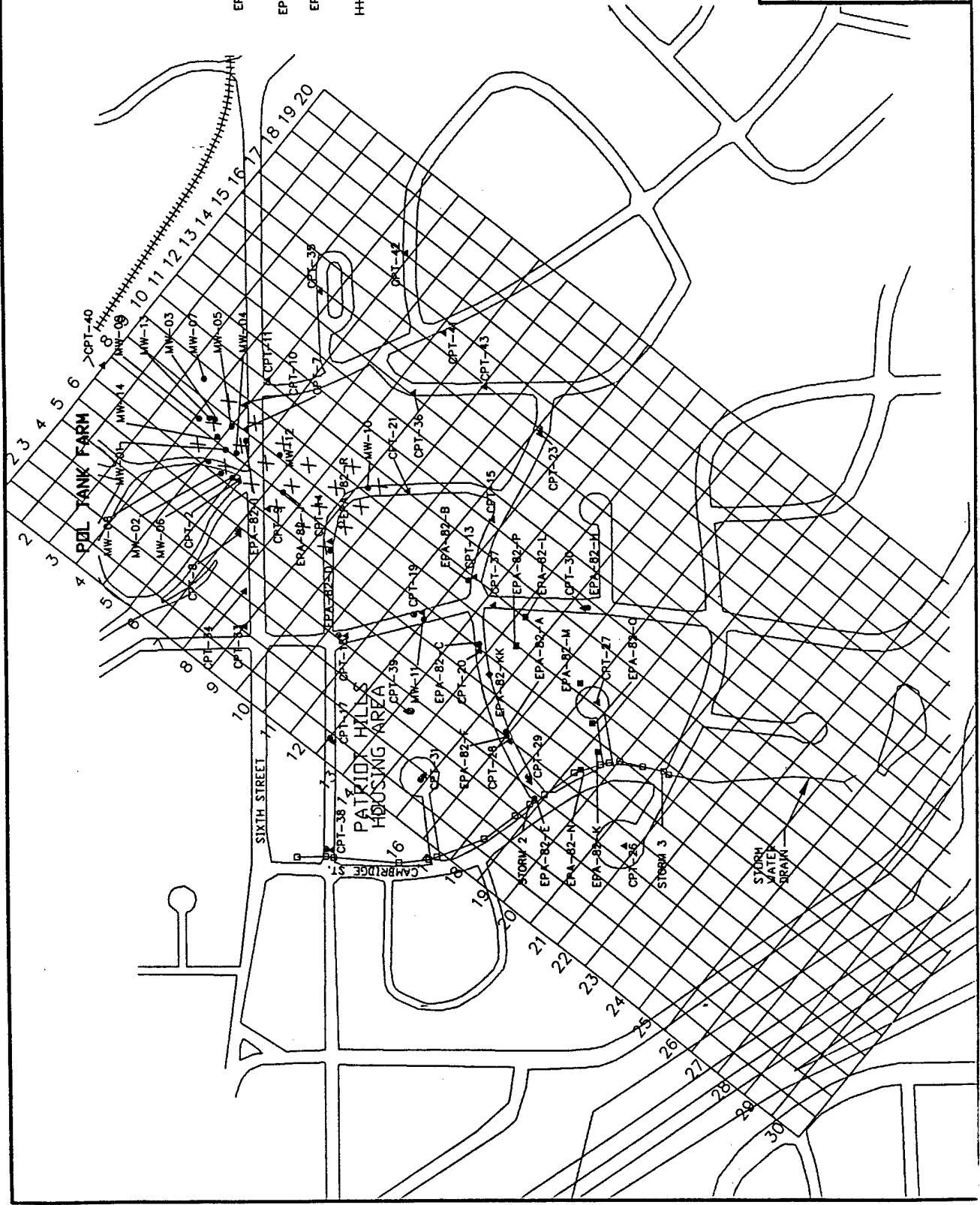

FIGURE 5.1

MODEL GRID INCLUDING INJECTION CELL LOCATIONS

UST Site 870
 Intrinsic Remediation EE/CA
 Hill Air Force Base, Utah

PARSONS ENGINEERING SCIENCE, INC.
 Denver, Colorado



continuing source of contamination caused by the mobile LNAPL present at the site. Injection well locations are shown in Figure 5.1 and are explained in detail in Section 5.5.

5.4.2 Ground Water Elevation and Gradient

The water table elevation data presented in Figure 3.5 were used as Bioplume II model input. Available site data suggest that there is almost no seasonal variation in ground water flow direction or gradient at the site (Appendix B and MWI, 1994). Ground water flow in the vicinity of UST Site 870 is to the southwest at an average gradient of approximately 0.048 ft/ft between wells EPA-82-I and EPA-82-E. As described in Section 5.5, the ground water flow model was calibrated to the observed water table.

5.4.3 BTEX Concentrations

The highest total-dissolved BTEX concentrations obtained from laboratory analytical data for the period through August 1993 were used for model development. Figure 4.4 shows the spatial distribution of the highest (most conservative) dissolved-phase BTEX compounds detected through August 1993. Table 4.4 contains dissolved BTEX concentration data. Appendix D contains the gridded total BTEX concentrations used as model input.

The BTEX data from Figure 4.4 was used in model development by placing the model grid over the isopleth contours. The total BTEX concentration used in the model, and shown in Appendix D, is an estimated average concentration of all the isopleth lines intersecting the boundaries within each model cell. The highest concentration isopleth lines were not used for allocating BTEX concentrations to model cells because a single isopleth concentration was not representative of the average total BTEX concentrations over the entire 85 feet by 110 feet model cell. Figure 5.2 shows the distribution of the BTEX plume as calculated by the Bioplume II model for $T=0$ for all models. Comparison of Figures 4.4 and 5.2 shows that there is good agreement between the actual BTEX distribution in the shallow saturated zone and the initial distribution calculated by the Bioplume II model. The initial BTEX plume covers an area of approximately 650,000 square feet (15 acres). The shape and distribution of the total BTEX plume is the result of advective transport of dissolved-phase BTEX contamination downgradient from the LNAPL contamination present in the source area.

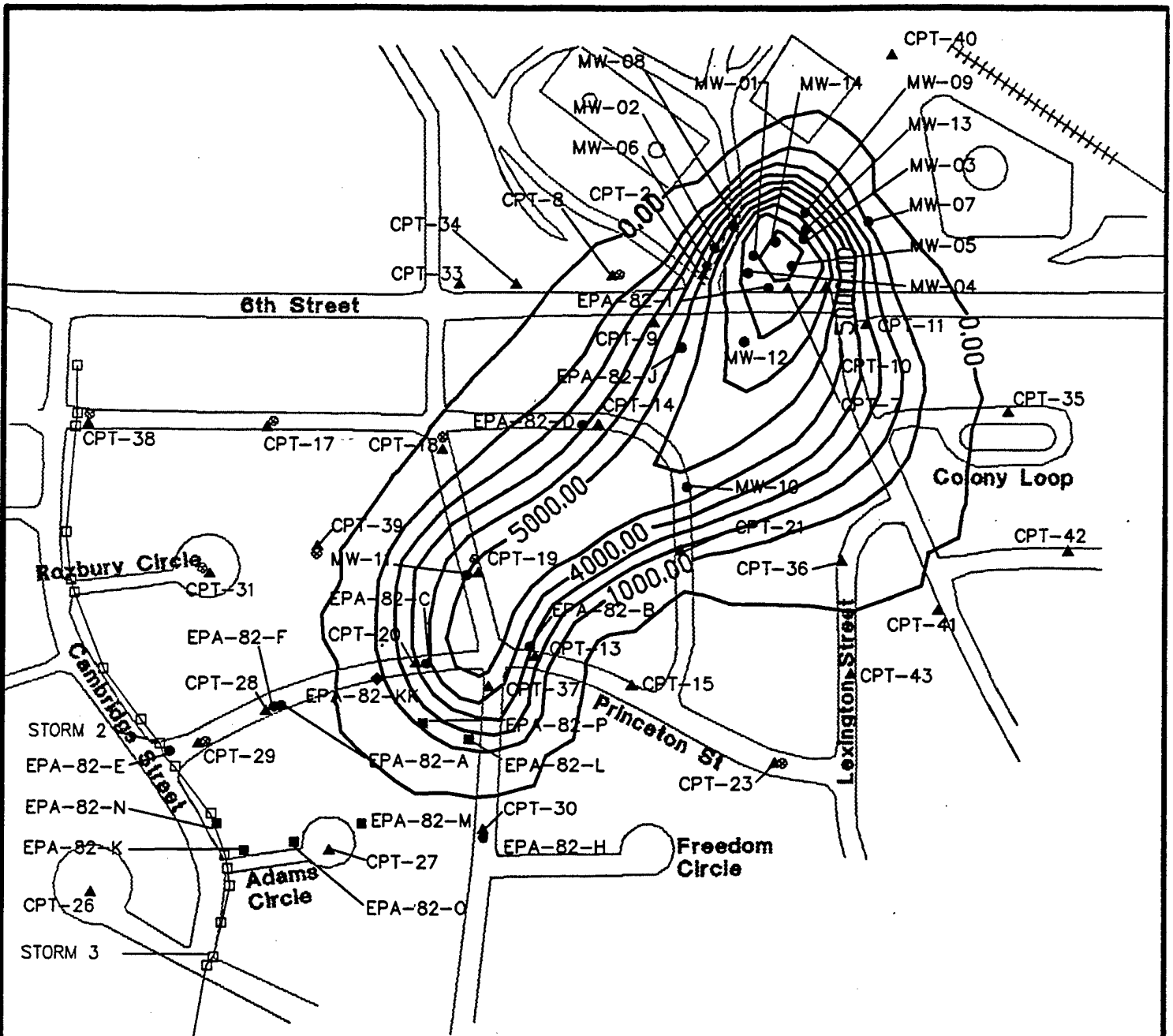

LEGEND

- CPT-26 ▲ CONE PENETROMETER TEST POINT/PIEZOMETER
- MW-11 ● MONITORING WELL LOCATION
- ⊙ AUGUST 1993 GEOPROBE SAMPLING LOCATION
- STORM DRAIN SURVEY LOCATION
- EPA-82-M JULY 1994 GEOPROBE SAMPLING
- EPA-82-KK ◆ JULY 1994 SOIL BORING LOCATION
- 1000— LINE OF EQUAL TOTAL BTEX CONCENTRATION (µg/L)
- CONTOUR INTERVAL = 1,000 µg/L



FIGURE 5.2
MODEL RESULTS
TOTAL DISSOLVED BTEX
ALL MODELS
T=0 YEAR
 UST Site 870
 Intrinsic Remediation EE/CA
 Hill Air Force Base, Utah

PARSONS
ENGINEERING SCIENCE, INC.
 Denver, Colorado

Partitioning of BTEX compounds from the LNAPL into the ground water is described in Section 5.5.

5.4.4 Hydraulic Conductivity

Hydraulic conductivity (K) is an important aquifer characteristic that determines the ability of the water-bearing strata to transmit ground water. An accurate estimate of this parameter is important to help quantify advective ground water flow velocities, to define the flushing potential of the aquifer, and to estimate the quantity of electron-acceptor-rich ground water that is entering the site from upgradient locations. Rifai *et al.* (1988) report that the Bioplume II model is particularly sensitive to variations in hydraulic conductivity. Lower values of hydraulic conductivity result in a slower-moving plume that degrades at a slower rate because less oxygen and nitrate are available for biodegradation. Higher values of hydraulic conductivity result in a faster moving plume that degrades at a faster rate because more oxygen and nitrate are available for biodegradation.

Based on slug tests performed at the site, hydraulic conductivity varies from 1.08×10^{-4} ft/s to 6.08×10^{-4} ft/s. This is within the accepted range for sandy materials (Freeze and Cherry, 1979). Slug test results used for modeling do not reflect slug test data collected by JMM (1993) at MW-1. MW-1 was screened in a soil interval characterized by silty sands with a large interval (~4 ft) of clayey sand. As a result, slug test data from MW-1 was not considered representative of the fine- to medium- grained sandy soils located around the screened monitoring wells used for Parsons ES slug tests in 1993. The sensitivity of the model to this parameter was evaluated during the sensitivity analysis described in Section 5.6.

5.4.5 Electron Acceptors (Oxygen and Nitrate)

As discussed previously, the Bioplume II model assumes an instantaneous reaction between the BTEX plume and the electron acceptors. As discussed in Section 4, it is apparent that DO, nitrate, ferric hydroxide, sulfate and carbon dioxide (methanogenesis) are being used as electron acceptors for biodegradation of BTEX compounds at UST Site 870. However, to be conservative, the total BTEX plume at UST Site 870 was modeled assuming that oxygen and nitrate were the only electron acceptors being utilized at a rate that is instantaneous relative to the advective ground water velocity for the biodegradation of the BTEX compounds.

The Bioplume II model was calibrated with DO as the only electron acceptor. The result of using DO as the only electron acceptor was a modeled BTEX plume that extended nearly twice as far (and past the Hill AFB boundary) downgradient than the plume observed in 1994. Based on these results, it was clear that DO is not the only electron acceptor being utilized for BTEX biodegradation. Successful calibration of the Bioplume II model required the use of nitrate, which is the most thermodynamically favorable electron acceptor following oxygen. Furthermore, decreases in nitrate concentrations from anaerobic biodegradation processes were observed in areas with reduced DO concentrations (compare Figures 4.6 and 4.7 with Figures 4.8 and 4.9, respectively). This strongly suggests both denitrification and aerobic oxidation are important biodegradation mechanisms at the site. Although some localized areas on the fringe of the BTEX plume overestimated the actual rate of denitrification because of background DO concentrations, both aerobic oxygenation and denitrification of BTEX contamination were widely observed in the same areas. Therefore, simulating nitrate concentrations with DO concentrations in the model was not an overgeneralization of site electron acceptor potential (as might initially be presumed), but instead was an improved representation of site conditions. Related modeling initiatives to improve simulations of BTEX biodegradation in ground water systems are being accomplished by incorporating nitrate, and other potential anaerobic electron acceptors (e.g., ferric iron, sulfate, and carbon dioxide) into the model code, specifically within the code of the soon-to-be released Bioplume III ground water model (Rifai, 1995).

The loss of DO and nitrate in the Bioplume II model was conceptualized with aerobic bacteria using DO, and then with anaerobic bacteria using nitrate as the next available electron acceptor. This assumption is justified based on the observation that aerobic oxidation and denitrification are important biodegradation mechanisms at the site. Once utilized, DO and nitrate will react instantaneously with BTEX relative to the advective groundwater velocity in the aquifer (Borden and Bedient, 1986; Wilson, 1994).

Ground water samples collected in uncontaminated portions of the aquifer indicate that background DO concentrations at the site are about 6.3 mg/L. To be conservative, background DO concentrations were assumed to be 5.0 mg/L for Bioplume II model development. Table 4.5 contains DO data for the site. Figures 4.6 and 4.7 are DO isopleth maps. Gridded oxygen input data are included in Appendix D.

Ground water samples collected in uncontaminated portions of the aquifer indicate that background nitrate (as N) concentrations at the site may be as high as 17 mg/L. However, to be conservative, nitrate (as N) concentrations around the periphery of the plume were assumed to be 5 mg/L for Bioplume II model development. Table 4.5 contains nitrate data for the site. Figures 4.8 and 4.9 are nitrate isopleth maps. Gridded nitrate data are included in Appendix D.

The upgradient constant-head cells in the Bioplume II model require background electron acceptor concentrations to be input as constant concentrations to simulate incoming electron acceptors. To be conservative, a DO concentration of 5 mg/L and a nitrate (as N) concentration of 10 mg/L was used for these cells.

Bioplume II[®] is capable of tracking only a single electron acceptor as an instantaneous reaction in model simulations (customarily DO) for estimating BTEX biodegradation. Consequentially, the model cannot estimate both DO and nitrate biodegradation mechanisms simultaneously unless one electron acceptor is mathematically converted to an equivalent form of the other. Denitrifying conditions were modeled by converting nitrate concentrations to equivalent oxygen concentrations. On a mass basis, 4.77 mg of ionic nitrate are required to oxidize 1 mg of benzene, whereas, only 3.08 mg of DO are required to oxidize the same mass of benzene. Hence, ionic nitrate has only 64.6 percent of the capacity to biodegrade benzene that DO does. Converted ionic nitrate concentrations were combined with DO concentrations for a total oxygen/ionic nitrate electron acceptor map. The calculations used to convert nitrate (as N) to oxygen equivalent ionic nitrate are discussed below.

Nitrate concentrations at UST Site 870 were reported together with nitrite concentrations as nitrate + nitrite (as N) by RSKERL. Based on these data it is not possible to determine the relative amounts of nitrate and nitrite (as N); however, because nitrite is considered metastable in the ground water environment, it was assumed that the combined nitrate + nitrite (as N) value was all nitrate (as N). The work of von Gunten and Zobrist (1993) supports this assumption as does site-specific data (Table 4.5). These workers conducted column experiments using nitrate as an electron acceptor and noted that only small amounts of nitrite were detected in the column in the early stages of the experiment, and after 20 days, nitrite was no longer detected.

The use of nitrate as an electron acceptor requires that nitrate (as N) concentrations be converted to ionic nitrate concentrations. To do this, the equivalent weight of oxygen must be added back to the nitrate (as N) concentration:

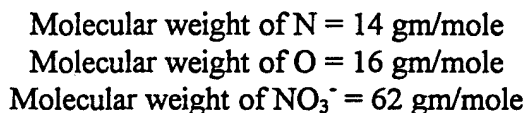

The percentage of N in NO_3^- is $14/62 = 22.58$ percent. Therefore, 1 gm of NO_3^- (as N) is equivalent to $1/0.2258 = 4.43$ gm of ionic NO_3^- . To convert nitrate (as N) into ionic nitrate concentrations, the measured nitrate (as N) concentration must be multiplied by 4.43.

Assuming complete mineralization of benzene to carbon dioxide and water, the reactions for aerobic respiration and denitrification are as follow:

Aerobic Respiration

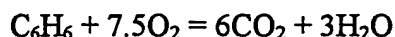

Denitrification

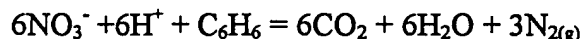

Based on this stoichiometry, 7.5 moles of DO are required to biodegrade 1 mole of benzene, and 6 moles of nitrate are required to biodegrade 1 mole of benzene. On a mass basis:

$$\begin{aligned}(7.5 \text{ moles O}_2)(32 \text{ gm/mole O}_2) &= 240 \text{ gm O}_2 \\ (6 \text{ moles NO}_3^-)(62 \text{ gm/mole NO}_3^-) &= 372 \text{ gm NO}_3^-\end{aligned}$$

From these relationships, it is apparent that, on a mass basis, more ionic nitrate than DO is required to oxidize a unit mass of benzene. By dividing the mass of ionic nitrate required to degrade one mole of benzene by the mass of DO required to degrade one mole of benzene, a ratio is derived that can be applied to ionic nitrate concentrations to obtain equivalent oxygen concentrations. This ratio is:

$$240 \text{ gm O}_2 / 372 \text{ gm NO}_3^- = 0.645 \text{ gm of O}_2 \text{ equivalent per gram of NO}_3^-$$

Therefore, 10 gm of NO_3^- has an O_2 equivalence of:

$$(10 \text{ gm NO}_3^-)(0.645 \text{ gm of O}_2 \text{ equivalent/gm of NO}_3^-) = 6.45 \text{ gm}$$

From these relationships, the following calculation must be performed to convert NO_3^- (as N) to an equivalent DO concentration:

$$(\text{NO}_3^- \text{ (as N) (gm/L)})(4.43 \text{ gm NO}_3^- \text{ (ion)/gm NO}_3^- \text{ (as N)})(0.65 \text{ gm O}_2 \text{ eq./gm NO}_3^-)$$

This relationship was used to convert measured nitrate (as N) concentrations into oxygen-equivalent ionic nitrate concentrations. To do this an isopleth map of nitrate (as N) was prepared and gridded. Gridded values of nitrate (as N) were then used in the relationship presented above to determine ionic NO_3^- as DO equivalence. These values were then added to existing DO concentrations previously gridded at the site and used as input into the Bioplume II model. Figure 5.3 shows the combined DO and NO_3^- (as DO equivalent concentrations) electron acceptor concentrations used in the Bioplume II model.

5.4.5 Dispersivity

Much controversy surrounds the concepts of dispersion and dispersivity. Longitudinal dispersivity values for alluvial sediments range from 0.1 to 200 feet (Walton, 1988). A longitudinal dispersivity of 53.4 feet was used in this model. This dispersivity was estimated by using one-tenth of the distance between the spill source and the longitudinal centroid of the plume. Transverse dispersivity values generally are at least one order of magnitude less than values of longitudinal dispersivity (Domenico and Schwartz, 1990). For this model, Parsons ES used 0.1 for the ratio of transverse dispersivity to longitudinal dispersivity. Use of an estimated value for dispersivity is appropriate because the Bioplume II model exhibits a weak sensitivity to dispersivity (Rifai *et al.*, 1988). In addition, the sensitivity of the model to the parameter was evaluated during the sensitivity analyses described in Section 5.6.

5.4.6 Retardation

Retardation of the BTEX compounds relative to the advective velocity of the ground water occurs when BTEX molecules are sorbed to the aquifer matrix. Based on measured TOC concentrations in an uncontaminated portion of the shallow saturated zone, and assuming a bulk density of 1.6 grams per cubic centimeter (gm/cc) (Freeze and Cherry, 1979), and

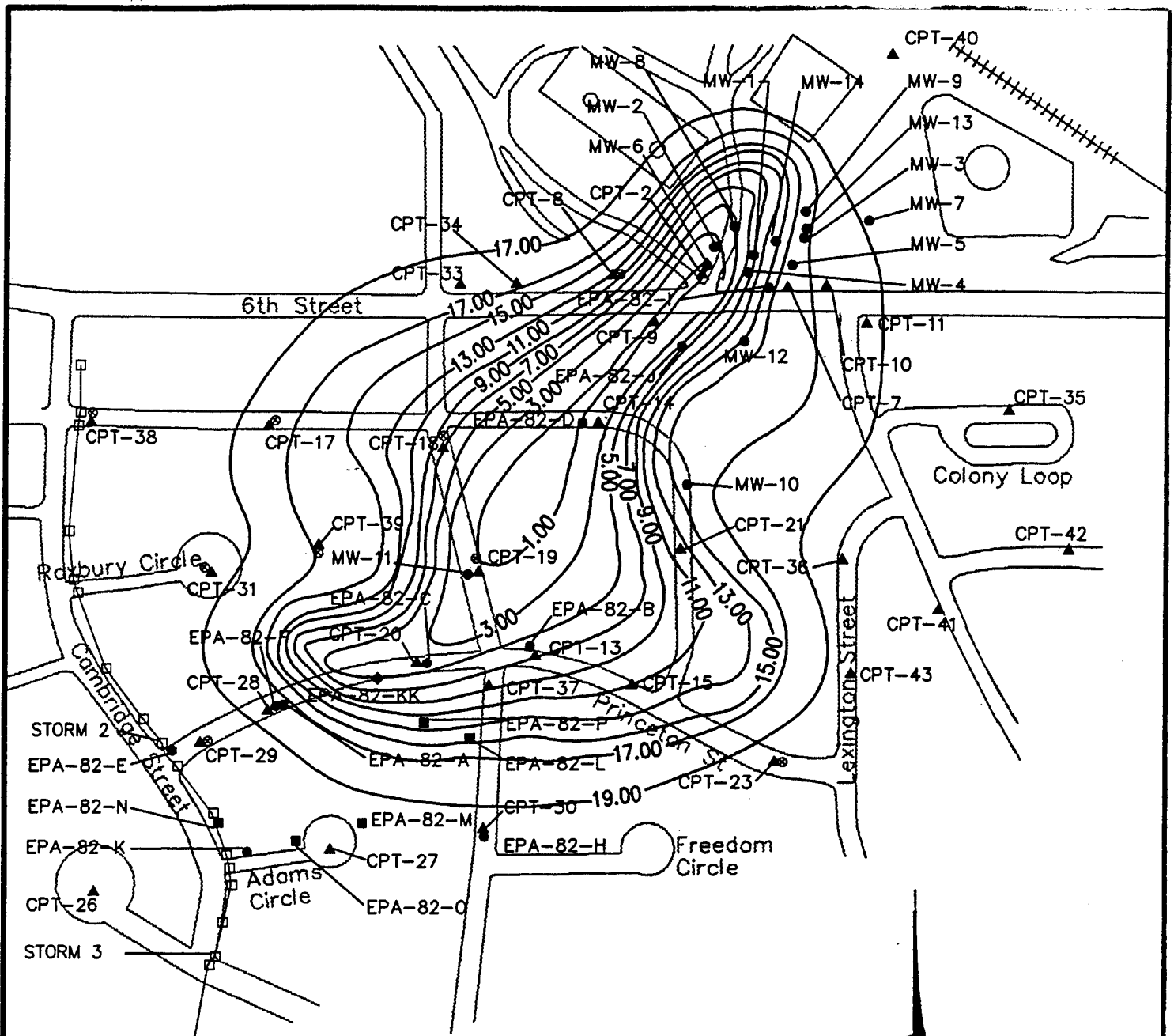

LEGEND

- CPT-26 ▲ CONE PENETROMETER TEST POINT/
PIEZOMETER
- MW-11 ● MONITORING WELL LOCATION
- ⊙ AUGUST 1993 GEOPROBE SAMPLING
LOCATION
- STORM DRAIN SURVEY LOCATION
- EPA-82-M ■ JULY 1994 GEOPROBE SAMPLING
LOCATION
- EPA-82-KK ◆ JULY 1994 SOIL BORING LOCATION
- 1000 — LINE OF EQUAL NITRATE
CONCENTRATION (mg/L)

CONTOUR INTERVAL = 1 mg/L



FIGURE 5.3
COMBINED DO AND NITRATE
ISOPLETH FOR GROUNDWATER
AUGUST 1993

UST Site 870
Intrinsic Remediation EE/CA
Hill Air Force Base, Utah

PARSONS
ENGINEERING SCIENCE, INC.

Denver, Colorado

published values of K_{oc} for the BTEX compounds (Martel, 1987), the coefficient of retardation for the BTEX compounds was calculated. The results of these calculations are summarized in Table 5.2. To be conservative, the minimum coefficient of retardation calculated for benzene (1.29) was used as model input.

5.4.7 Reaeration

The reaeration coefficient is a first-order decay rate constant used by Bioplume II to simulate the replenishment of oxygen into the ground water by soil gas diffusion and rainwater infiltration. Recent data on first-order biodegradation rate coefficients in groundwater at Hill AFB suggest that biodegradation rates ranged from 0.010 to 0.032 day^{-1} over the center and periphery of the groundwater contaminant plume (Wiedemeier *et al.*, 1994). To be conservative, a first-order biodegradation rate coefficient of 0.003 day^{-1} was used in this model. This rate coefficient was increased and decreased by one order of magnitude during the sensitivity analyses described in Section 5.6.

5.5 MODEL CALIBRATION

Model calibration is an important component in the development of any numerical ground water model. Calibration of the flow model demonstrates that a model is capable of matching hydraulic and chemical conditions observed in the field. The numerical model presented herein was calibrated by altering hydraulic parameters, boundary conditions, and stresses (i.e., injection cells) in a trial-by-error fashion until simulated heads and BTEX plumes approximated observed field conditions.

5.5.1 Water Table Calibration

The shallow water table at UST Site 870 was assumed to be influenced only by continuous recharge and discharge at the constant-head cells established at the upgradient and downgradient model boundaries. To be conservative, annual recharge of the aquifer through rainfall was not included in the model. Potential recharge by leaky stormwater sewers, collection ponds, or other sources was omitted because of a lack of reliable data. Only the

TABLE 5.2
RETARDATION CALCULATIONS FOR THE BTEX COMPOUNDS
UST SITE 870 INTRINSIC REMEDIATION EE/CA
HILL AFB, UTAH

Compound	K_{oc} (L/kg ^{a/})	Maximum Fraction Organic Carbon ^{b/}		Minimum Fraction Organic Carbon ^{b/}		Average Fraction Organic Carbon ^{b/}	Distribution Coefficient (L/kg) Maximum ^{e1/} Minimum ^{e2/}		Bulk Density (kg/L) ^{d/}	Effective Porosity	Coefficient of Retardation	
		0.00094	0.00069	0.00069	0.00069		0.074	0.055			Maximum	Minimum
Benzene	79	0.00094	0.00069	0.00069	0.00069	0.00859	0.074	0.055	1.60	0.30	1.40	1.29
Toluene	190	0.00094	0.00069	0.00069	0.00069	0.00859	0.179	0.131	1.60	0.30	1.95	1.70
Ethylbenzene	468	0.00094	0.00069	0.00069	0.00069	0.00859	0.440	0.323	1.60	0.30	3.35	2.72
m-xylene	405	0.00094	0.00069	0.00069	0.00069	0.00859	0.381	0.279	1.60	0.30	3.03	2.49
o-xylene	422	0.00094	0.00069	0.00069	0.00069	0.00859	0.397	0.291	1.60	0.30	3.12	2.55
p-xylene	357	0.00094	0.00069	0.00069	0.00069	0.00859	0.336	0.246	1.60	0.30	2.79	2.31

NOTES:

^{a/} From technical protocol document (Wiedemeier *et al.*, 1994).

^{b/} From Upper Naknek data.

^{e1/} K_d = Maximum Fraction Organic Carbon x K_{oc} .

^{e2/} K_d = Minimum Fraction Organic Carbon x K_{oc} .

^{d/} Literature values.

initial water levels at the constant-head cells and the transmissivity were varied to calibrate the water table surface. The model was calibrated under steady-state conditions.

Saturated thickness data from borehole logs, CPT reports, and water level measurements were used in conjunction with the average hydraulic conductivity as determined from slug tests (2.64×10^{-4} ft/s) to estimate transmissivity. To better match heads in the model to observed values, the transmissivities were progressively varied in rows and blocks until the potentiometric surface approximated the existing potentiometric surface within a 5-percent average variance. Thirteen monitoring wells and piezometer locations were used to compare between the measured and simulated heads of the final calibrations. The 13 selected locations were EPA-82-I, EPA-82-D, EPA-82-B, EPA-82-C, EPA-82-F, EPA-82-E, EPA-82-H, CPT-41, CPT-23, CPT-21, CPT-15, CPT-31, and MW-12. The root-mean-square (rms) error between observed and calibrated values at these points was 3.2 feet which corresponds to a calibration error of 2.5 percent (water levels dropped approximately 130 feet from northeast to southwest across the model grid). A plot of measured vs. calibrated heads shows a random distribution of calibrated heads and is shown in Appendix D. Deviation of points from a straight line should be randomly distributed in computer simulations (Anderson and Woessner, 1992).

In solving the ground water flow equation, Bioplume II establishes the water table surface and calculates an overall hydraulic balance that accounts for the numerical difference between flux into and out of the system. The hydraulic mass balance for the calibrated model was excellent, with 99.95 percent of the water flux into and out of the system being numerically accounted for. Figure 5.4 shows the calibrated water table.

5.5.2 BTEX Plume Calibration

Model input parameters affecting the distribution and concentration of the simulated BTEX plume were modified so that initial model results closely matched dissolved-phase total BTEX concentrations observed in August 1993, and model predictions approximated dissolved-phase total BTEX concentrations observed in July 1994. The extent of dissolved-phase BTEX contamination in 1993 and 1994 is described in Section 4.3.1. Because LNAPL is present at the site, it was necessary to include 20 injection cells to simulate partitioning of BTEX compounds from the LNAPL into the ground water. The location of the injection cells is shown on Figure 5.1. Chemical analysis of LNAPL from MW-10 indicate that the

PDL TANK FARM

PATRIOT HILLS HOUSING AREA

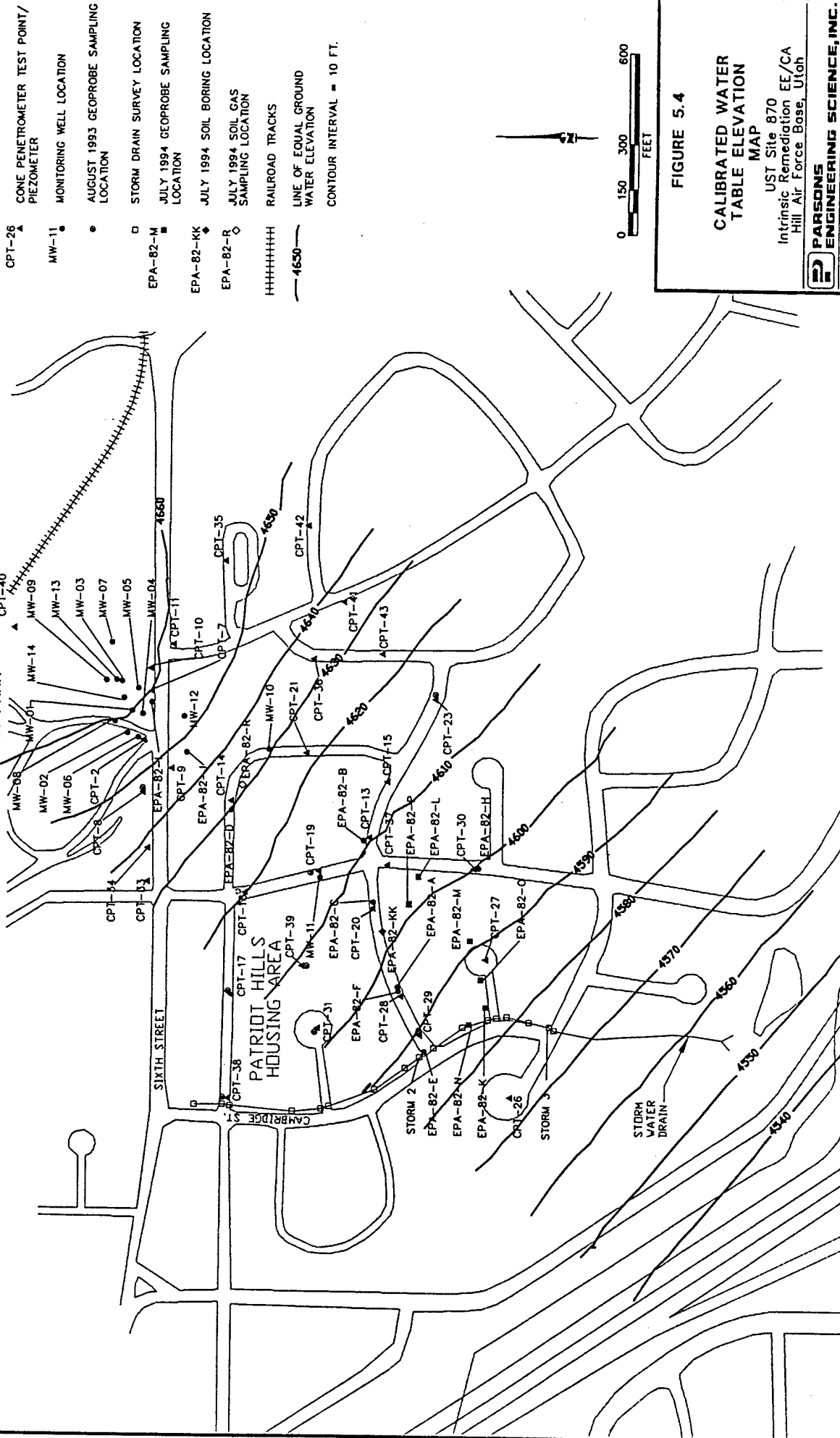

- LEGEND**
- CPT-26 ▲ CONE PENETROMETER TEST POINT/PIEZOMETER
 - MW-11 ● MONITORING WELL LOCATION
 - AUGUST 1993 GEOPROBE SAMPLING LOCATION
 - STORM DRAIN SURVEY LOCATION
 - EPA-82-M ■ JULY 1994 GEOPROBE SAMPLING LOCATION
 - EPA-82-KK ◆ JULY 1994 SOIL BORING LOCATION
 - EPA-82-R ○ JULY 1994 SOIL GAS SAMPLING LOCATION
 - HHHHHHHH RAILROAD TRACKS
 - 4650— LINE OF EQUAL GROUND WATER ELEVATION
 - 10 FT. CONTOUR INTERVAL = 10 FT.



FIGURE 5.4

CALIBRATED WATER TABLE ELEVATION MAP

UST Site 870
Intrinsic Remediation EE/CA
Hill Air Force Base, Utah

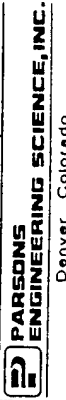

LNAPL at the site is probably dominated by JP-4 jet fuel. LNAPL contamination is estimated to cover an area of approximately 225,000 square feet (Figure 4.1).

The injection rate of the cells was set at 5 cubic feet per day (cfd), a value low enough so that the ground water elevation calibration was not affected. Total BTEX injection concentrations were determined by varying the injection concentration in the various cells from 1 to 1,650 mg/L until the initial total BTEX plume generated by the model approximated the total BTEX plume observed in August 1993, and the model predictions approximated the change in dissolved-phase total BTEX concentrations that occurred between August 1993 and July 1994. Relatively high BTEX concentrations were injected in upgradient injection cells because of the influx of 34 mg/L of combined oxygen and ionic nitrate electron acceptor concentrations (5 mg/L DO and 10 mg/L nitrate as N) introduced at the upgradient constant-head cells. This high replenishment of available electron acceptors quickly degraded BTEX concentrations at the head of the plume as they flushed through the aquifer, which in turn required large injection concentrations of BTEX to maintain observed BTEX contours. By varying the injection well concentrations, the BTEX plume was calibrated reasonably well to the change in the total BTEX plume between August 1993 and July 1994 in terms of migration distance and BTEX concentrations directly under the LNAPL contamination.

5.6 SENSITIVITY ANALYSIS

The purpose of the sensitivity analysis is to determine the effect of varying model input parameters on model output. Based on the work of Rifai *et al.* (1988), the Bioplume II model is most sensitive to changes in the coefficient of reaeration, the coefficient of anaerobic decay, and the hydraulic conductivity of the media, and is less sensitive to changes in the retardation factor, porosity, and dispersivity. A first-order anaerobic decay coefficient was not used because nitrate was included in the original oxygen map to simulate anaerobic biodegradation at the site. Because the coefficient of anaerobic decay was set to zero, the sensitivity analysis was conducted by varying the hydraulic conductivity (and therefore transmissivity) and the coefficient of reaeration. Because of the potential for large dispersivity values at the site, a sensitivity analysis was also performed on this parameter.

To perform the sensitivity analyses, an individual run of the model was made with the same input as the calibrated model, except that one of the aforementioned parameters was varied. The models were run for 10 years so that the independent effect of each variable could be

assessed. As a result, six sensitivity runs of the calibrated model were made, with the following variations:

- 1) Hydraulic conductivity uniformly increased by a factor of 5;
- 2) Hydraulic conductivity uniformly decreased by a factor of 0.2;
- 3) Longitudinal dispersivity increased to 100;
- 4) Longitudinal dispersivity decreased to 5.34;
- 5) Reaeration coefficient increased to 0.03 day^{-1} ; and
- 6) Reaeration coefficient decreased to 0.0003 day^{-1} .

The results of the sensitivity analyses are shown graphically in Figures 5.5, 5.6, and 5.7. These figures display the modeled BTEX concentrations versus distance along the centerline of the plume. This manner of displaying data is useful because the plume is narrow and maintains a constant plume migration direction parallel to the model grid. Furthermore, the figures allow easy visualization of the changes in BTEX concentration caused by varying model input parameters.

Uniformly increasing the hydraulic conductivity in the model by half an order of magnitude (model H1) drastically increased the migration rate and biodegradation rate of the plume (Figure 5.5). Plume migration and influx of fresh electron acceptors was so rapid that no appearance of BTEX concentrations was predicted by the model. This was caused by an abnormally high influx of electron acceptors in the highly conductive aquifer that immediately biodegraded existing and injected BTEX concentrations. In contrast, decreasing the hydraulic conductivity by a half-order of magnitude slowed plume migration, which in turn caused an increase in measured BTEX levels in the source area. Increased BTEX concentrations in the source area are caused by a reduction in the amount of electron acceptors being brought into contact with the plume from upgradient locations.

The effect of varying the coefficient of reaeration is shown in Figure 5.6. Decreases in total BTEX mass in ground water caused by increasing the reaeration coefficient from 0.003 day^{-1} to 0.03 day^{-1} was significant, and complete biodegradation of all existing and injected

FIGURE 5.5
 PLOT OF TOTAL BTEX VS DISTANCE ALONG PLUME
 CENTERLINE WITH VARYING HYDRAULIC CONDUCTIVITY
 UST SITE 870 INTRINSIC REMEDIATION EE/CA
 HILL AFB, UTAH

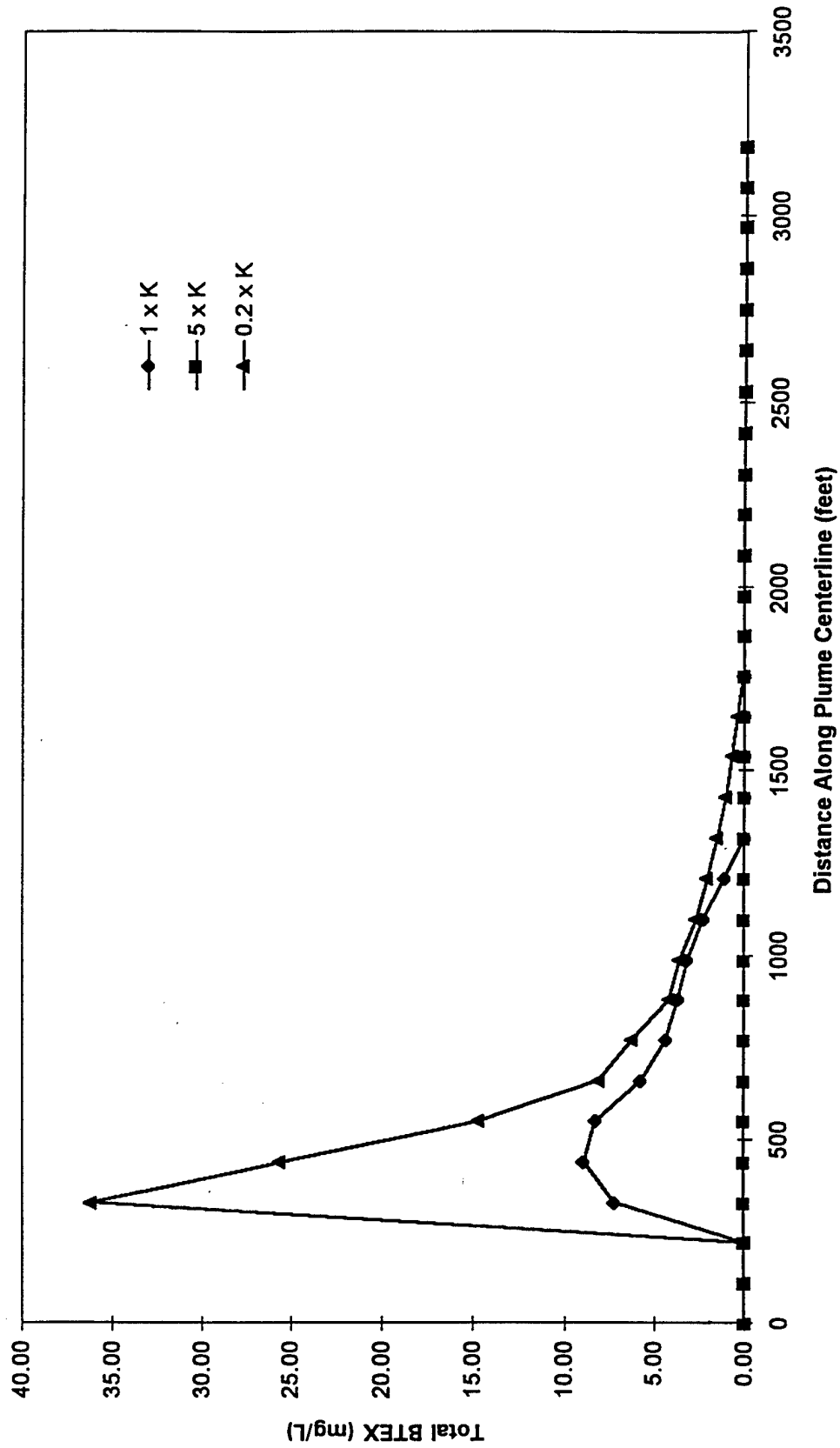

FIGURE 5.6
 PLOT OF TOTAL BTEX VS DISTANCE ALONG PLUME
 CENTERLINE WITH VARYING COEFFICIENT OF REAERATION
 UST SITE 870 INTRINSIC REMEDIATION EE/CA
 HILL AFB, UTAH

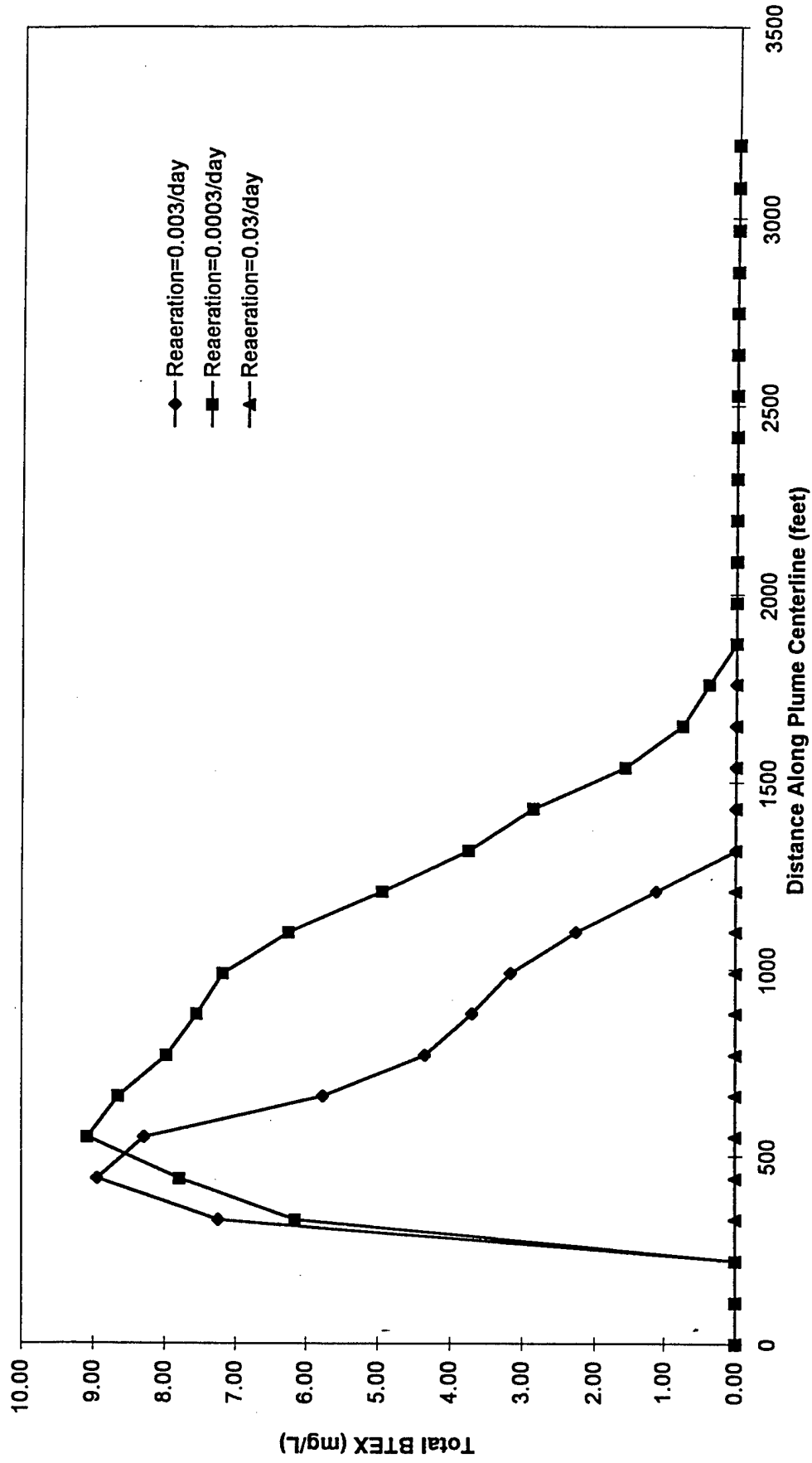
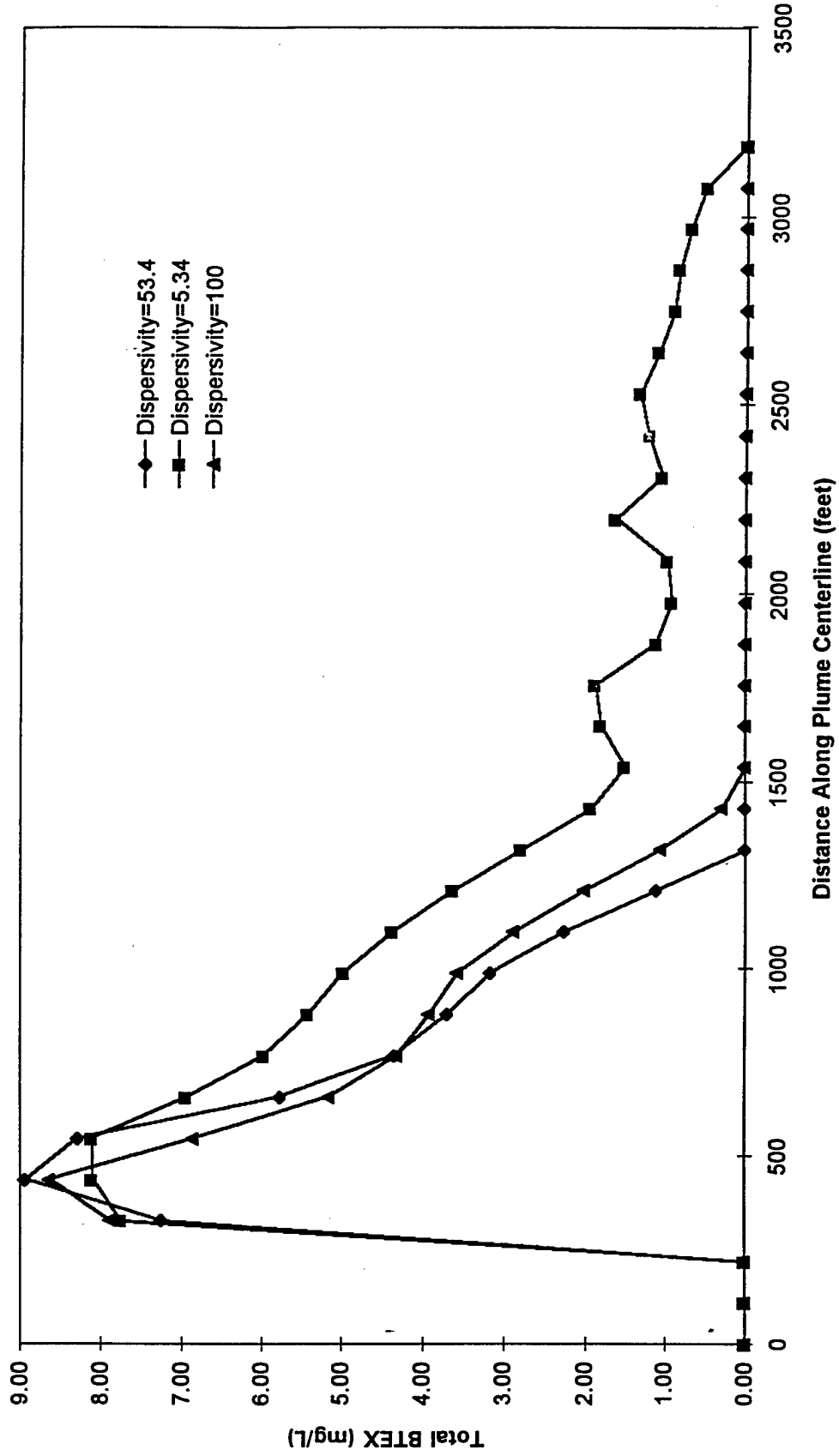

FIGURE 5.7
PLOT OF TOTAL BTEX VS DISTANCE ALONG
PLUME CENTERLINE WITH VARYING DISPERSIVITY
UST SITE 870 INTRINSIC REMEDIATION EE/CA
HILL AFB, UTAH



BTEX occurred instantaneously. By reducing the reaeration coefficient by an order of magnitude, a more modest change in the shape of the plume occurred. The downgradient end of the plume extended approximately 500 feet past its observed location.

Figure 5.7 illustrates the effects of varying longitudinal dispersivity. Decreasing the dispersivity resulted in a larger migration distance for the BTEX plume. This occurs because lowering the dispersivity keeps the plume from spreading out into more electron acceptor-rich portions of the aquifer. Increasing the dispersivity resulted in faster dilution of BTEX in the source area; however, the migration distance of the BTEX was only slightly altered by increasing the dispersivity.

The results of the sensitivity analysis suggest that the calibrated model used for this report is reasonable. Increasing the coefficient of reaeration or the hydraulic conductivity greatly affects the predicted BTEX concentration and distribution. Lowering the values of these variables causes an abnormal lengthening of the plume to beyond reasonable distances based on observations made at the site between August 1993 and July 1994. The calibrated model appears to reasonably simulate the observed BTEX plume.

5.7 MODEL RESULTS

The Bioplume II[®] model was run under steady-state conditions with no LNAPL removal, 5-percent annual LNAPL removal, and 15-percent annual LNAPL removal until the plume reached steady-state equilibrium (no LNAPL removal) or until the plume disappeared (LNAPL removal scenarios). The model with no LNAPL removal best simulated the current site conditions. As previously mentioned, LNAPL contamination at the site is extensive. LNAPL reduction through source removal, in concert with natural attenuation can significantly reduce the longevity of the BTEX contamination at the site.

Although the results of each model run varied depending on the amount of LNAPL dissolution over time, two trends were consistently observed, including:

- 1) The plume shape in each simulation is elongated because of the rapid advective transport of BTEX contamination and rapid biodegradation of BTEX at the plume periphery. This is consistent with what was observed between August 1993 and July 1994 (Figures 4.4 and 4.5);

- 2) A BTEX partitioning threshold develops in the two models that simulate a reduction in the LNAPL source term. In both models the hydrocarbon plume disappears when the BTEX injection concentration is reduced to approximately 55 percent of its original value. This occurs because replenished electron acceptor concentrations greatly exceed the BTEX contamination introduced into the aquifer by the prescribed biodegradation ratio of DO and DO-equivalent nitrate to BTEX of 3.1:1

The following sections describe the results of each model scenario.

5.7.1 No Source Removal (Model Hill-A)

Model Hill-A simulated the migration and biodegradation of the BTEX plume assuming no LNAPL weathering or removal. Approximately 3,900 gm (39,000 mg or 390,000 μg) of dissolved-phase BTEX contamination existed at the start of modeling ($T=0$, based on data from August 1993). This estimate was calculated by Bioplume II, which summed all dissolved BTEX contamination over the Hill AFB model domain at time zero. Contaminant migration was rapid because of the high hydraulic conductivity and steep hydraulic gradient present at the site. The total BTEX plume thins in shape and stretches just past Cambridge Street after 1 year (Figure 5.8). The Bioplume II model predicted that the plume would reach steady-state equilibrium within 4 years. Figures 5.8 and 5.9 show the predicted total BTEX concentrations at years 1 and 10. The plume migrates in the expected southwest direction, and by 1 year, levels of greater than 1 $\mu\text{g/L}$ of dissolved-phase BTEX are predicted to reach the vicinity of Cambridge Street in the Patriot Hills Housing complex. However, the stabilized plume (> 4 years) has slightly receded and only extends as far as the intersection of Cambridge Street and Adams Circle. The stabilized plume predicted by the model closely resembles the plume observed at the site in July 1994. Differences in modeled and actual plume shape are caused by physical, chemical, and biological variations within the shallow saturated zone that result from natural aquifer heterogeneity.

5.7.2 Five-Percent Annual Source Removal (Model Hill-B)

Model Hill-B simulated the migration and biodegradation of the BTEX plume assuming a 5-percent annual reduction in source BTEX concentrations caused by natural weathering processes and limited source removal by LNAPL skimming and bioventing. Model Hill-B is

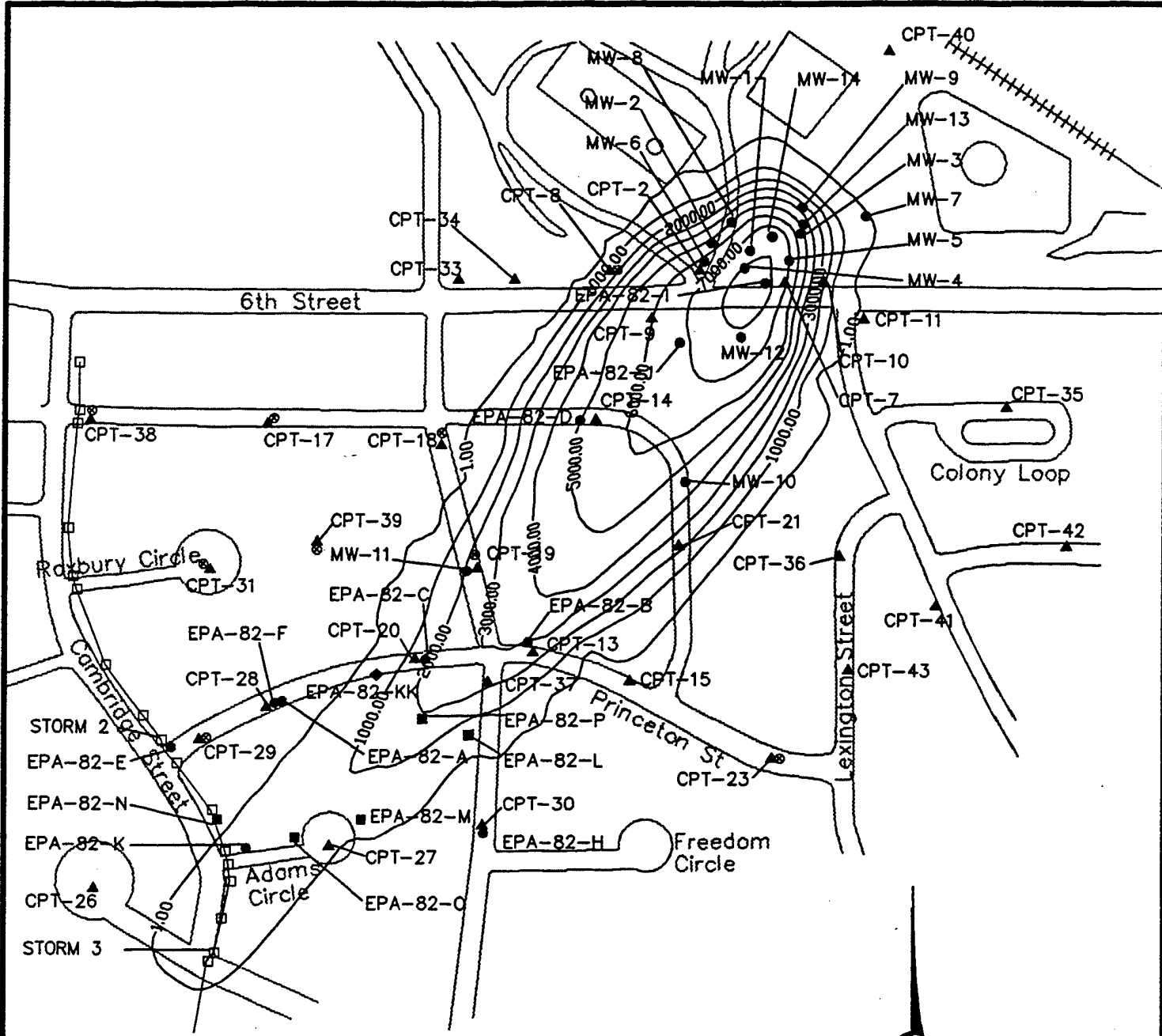

LEGEND

- CPT-26 ▲ CONE PENETROMETER TEST POINT/
PIEZOMETER
- MW-11 ● MONITORING WELL LOCATION
- AUGUST 1993 GEOPROBE SAMPLING
LOCATION
- STORM DRAIN SURVEY LOCATION
- EPA-82-M ■ JULY 1994 GEOPROBE SAMPLING
LOCATION
- EPA-82-KK ◆ JULY 1994 SOIL BORING LOCATION
- 1 — LINE OF EQUAL TOTAL
BTEX CONCENTRATION (UG/L)



FIGURE 5.8
MODEL RESULTS
TOTAL DISSOLVED BTEX
NO LNAPL REMOVAL
T=1 YEAR

UST Site 870
 Intrinsic Remediation EE/CA
 Hill Air Force Base, Utah



PARSONS
ENGINEERING SCIENCE, INC.

Denver, Colorado

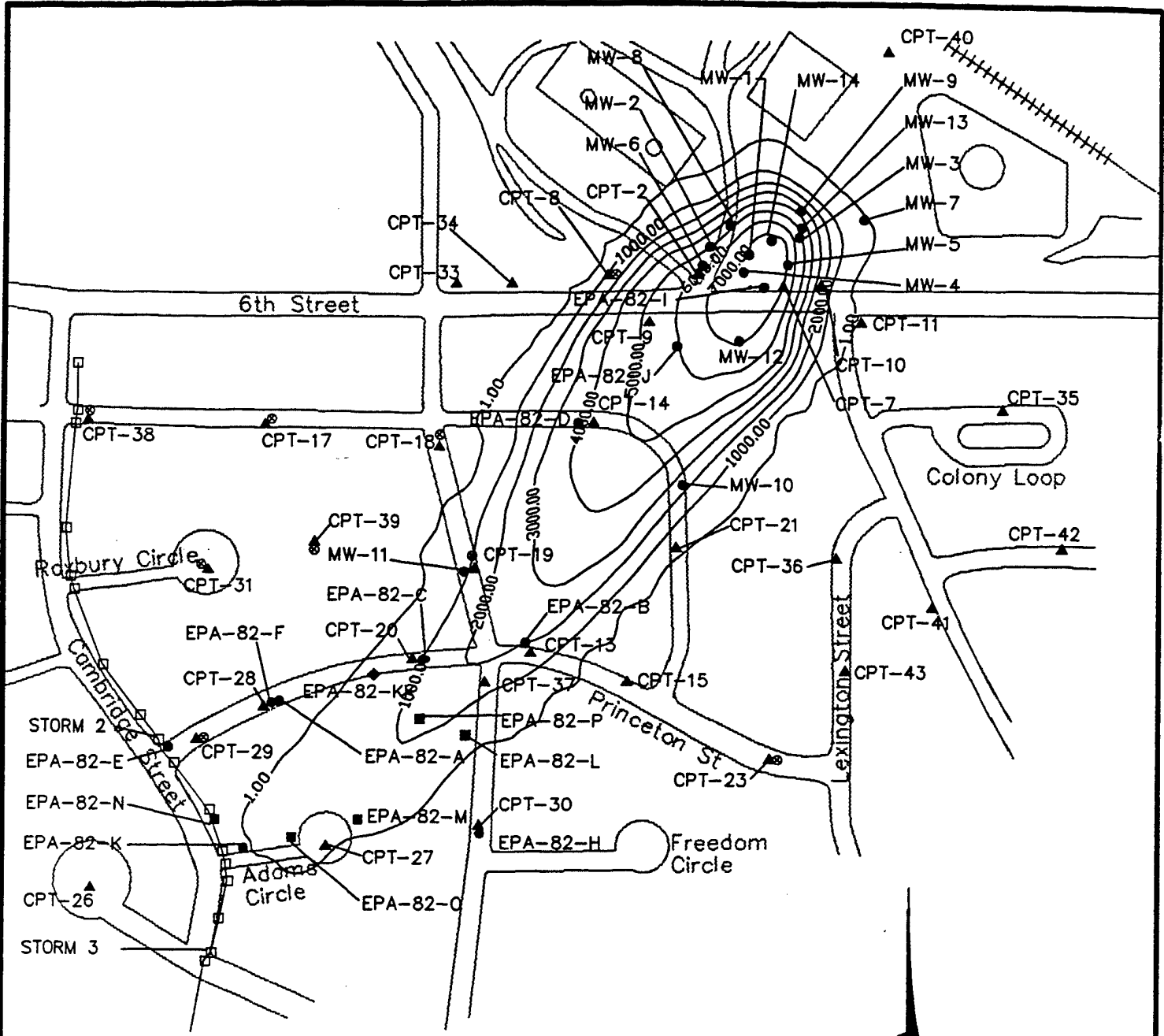

LEGEND

- CPT-26 ▲ CONE PENETROMETER TEST POINT/PIEZOMETER
- MW-11 ● MONITORING WELL LOCATION
- AUGUST 1993 GEOPROBE SAMPLING LOCATION
- STORM DRAIN SURVEY LOCATION
- EPA-82-M ■ JULY 1994 GEOPROBE SAMPLING LOCATION
- EPA-82-KK ◆ JULY 1994 SOIL BORING LOCATION
- 1 — LINE OF EQUAL TOTAL BTEX CONCENTRATION (UG/L)



FIGURE 5.9
MODEL RESULTS
TOTAL DISSOLVED BTEX
NO LNAPL REMOVAL
T=10 YEARS

UST Site 870
 Intrinsic Remediation EE/CA
 Hill Air Force Base, Utah

PARSONS
ENGINEERING SCIENCE, INC.
 Denver, Colorado

identical to model Hill-A with the exception of the 5-percent annual source removal term. Figures 5.10, 5.11, and 5.12 show the results of this model. The simulation time of the model was 25 years because 20 years were required before the LNAPL was theoretically reduced to 0 percent of its original partitioning strength. Despite the lengthy estimated period required to remove all the LNAPL contamination, BTEX disappeared in model simulations long before free-phase partitioning of BTEX from the LNAPL into the ground water ceased. The initial extent and concentration of BTEX contamination in years 1 and 2 were nearly identical to those predicted in model Hill-A. However, after 4 years the plume had noticeably receded at the periphery and the internal concentrations of BTEX were reduced by as much as 2 mg/L (2,000 µg/L). By year 7, the plume was approximately 10 percent of its original area, and the maximum concentration of BTEX was predicted to be only 300 µg/L in the source area. The reach of contamination at this point extends roughly 100 feet northwest of the intersection at Princeton Street and Liberty Road. Although BTEX partitioning was simulated for the first 19 years of the pumping period, dissolved-phase BTEX contamination was estimated to be completely degraded after 7 years. This situation is caused by the influx of electron acceptors by upgradient replenishment and reaeration that exceed the levels required to biodegrade the BTEX contamination injected into the 20 injection cells of the model grid.

5.7.3 Fifteen-Percent Annual Source Removal (Model Hill-C)

Model Hill-C simulated the migration and biodegradation of the BTEX plume assuming a 15-percent annual reduction in source BTEX concentrations caused by natural weathering processes and more active source removal by expanded LNAPL pumping and expanded bioventing. Model Hill-C is identical to model Hill-A with the exception of the 15-percent annual source removal term. Figures 5.13 and 5.14 show the results of this model for 1 and 3 years after the implementation of a 15-percent annual source removal technology. The initial 1 year prediction of plume migration suggests that the plume would extend as far as Cambridge Street at concentrations of 1 µg/L. By year 3 (Figure 5.14), the BTEX plume had undergone significant loss, including a complete reduction of BTEX contamination in the source area. By year 4, the plume had entirely disappeared. This complete plume disappearance at year 4 was caused by the injection loading rates of modeled BTEX to be reduced to 55 percent of the original loading rate, which was below the biodegradation capacity of the upgradient, influent electron acceptors and aquifer reaeration.

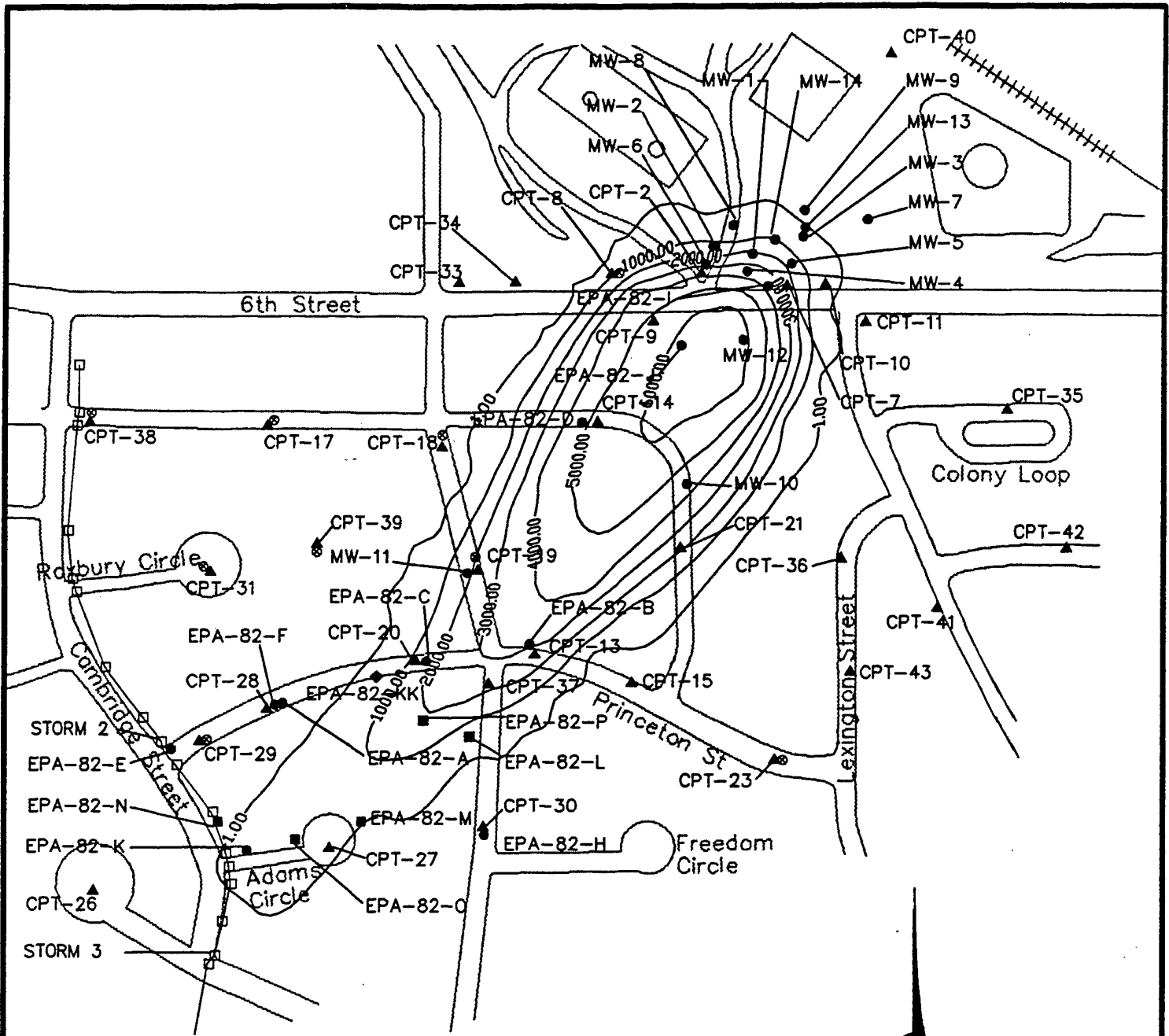

LEGEND

- CPT-26 ▲ CONE PENETROMETER TEST POINT/
PIEZOMETER
- MW-11 ● MONITORING WELL LOCATION
- ⊙ AUGUST 1993 GEOPROBE SAMPLING
LOCATION
- STORM DRAIN SURVEY LOCATION
- EPA-82-M ■ JULY 1994 GEOPROBE SAMPLING
LOCATION
- EPA-82-KK ◆ JULY 1994 SOIL BORING LOCATION
- 1 — LINE OF EQUAL TOTAL
BTEX CONCENTRATION (UG/L)



FIGURE 5.10
MODEL RESULTS
TOTAL DISSOLVED BTEX
5% ANNUAL LNAPL REMOVAL
T=1 YEAR

UST Site 870
 Intrinsic Remediation EE/CA
 Hill Air Force Base, Utah

PARSONS
ENGINEERING SCIENCE, INC.
 Denver, Colorado

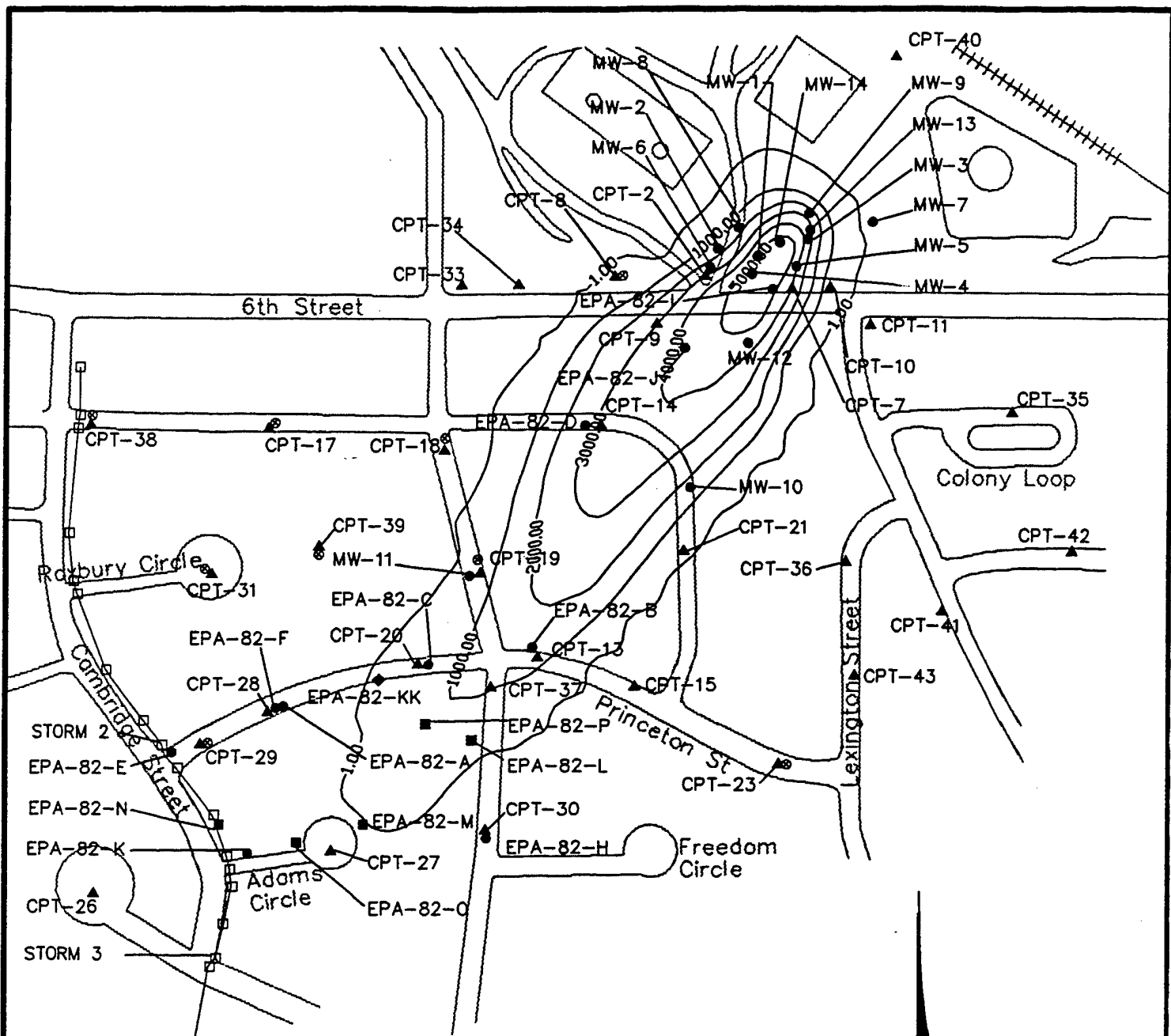

LEGEND

- CPT-26 ▲ CONE PENETROMETER TEST POINT/
PIEZOMETER
- MW-11 ● MONITORING WELL LOCATION
- ⊙ AUGUST 1993 GEOPROBE SAMPLING
LOCATION
- STORM DRAIN SURVEY LOCATION
- EPA-82-M ■ JULY 1994 GEOPROBE SAMPLING
LOCATION
- EPA-82-KK ◆ JULY 1994 SOIL BORING LOCATION
- 1 — LINE OF EQUAL TOTAL BTEX
CONCENTRATION (µg/L)

CONTOUR INTERVAL = 1,000 µg/L



FIGURE 5.11
MODEL RESULTS
TOTAL DISSOLVED BTEX
5% ANNUAL LNAPL REMOVAL
T=4 YEARS
 UST Site 870
 Intrinsic Remediation EE/CA
 Hill Air Force Base, Utah

PARSONS
ENGINEERING SCIENCE, INC.
 Denver, Colorado

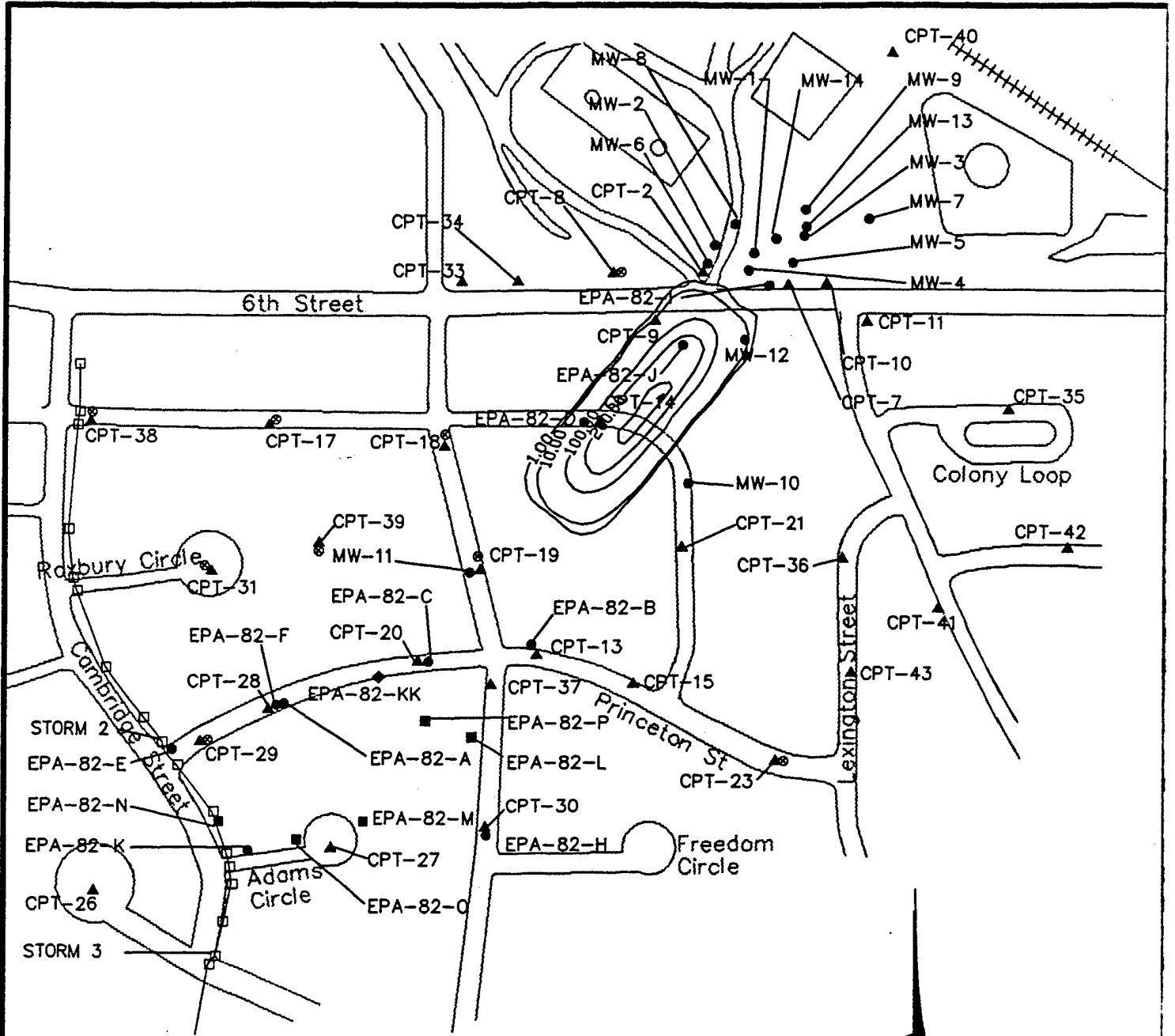

LEGEND

- CPT-26 ▲ CONE PENETROMETER TEST POINT/PIEZOMETER
- MW-11 ● MONITORING WELL LOCATION
- AUGUST 1993 GEOPROBE SAMPLING LOCATION
- STORM DRAIN SURVEY LOCATION
- EPA-82-M ■ JULY 1994 GEOPROBE SAMPLING LOCATION
- EPA-82-KK ◆ JULY 1994 SOIL BORING LOCATION
- 1 — LINE OF EQUAL TOTAL BTEX CONCENTRATION (µg/L)

CONTOUR INTERVAL = 100 µg/L



FIGURE 5.12
MODEL RESULTS
TOTAL DISSOLVED BTEX
5% ANNUAL LNAPL REMOVAL
T=7 YEARS

UST Site 870
 Intrinsic Remediation EE/CA
 Hill Air Force Base, Utah

PARSONS
ENGINEERING SCIENCE, INC.
 Denver, Colorado

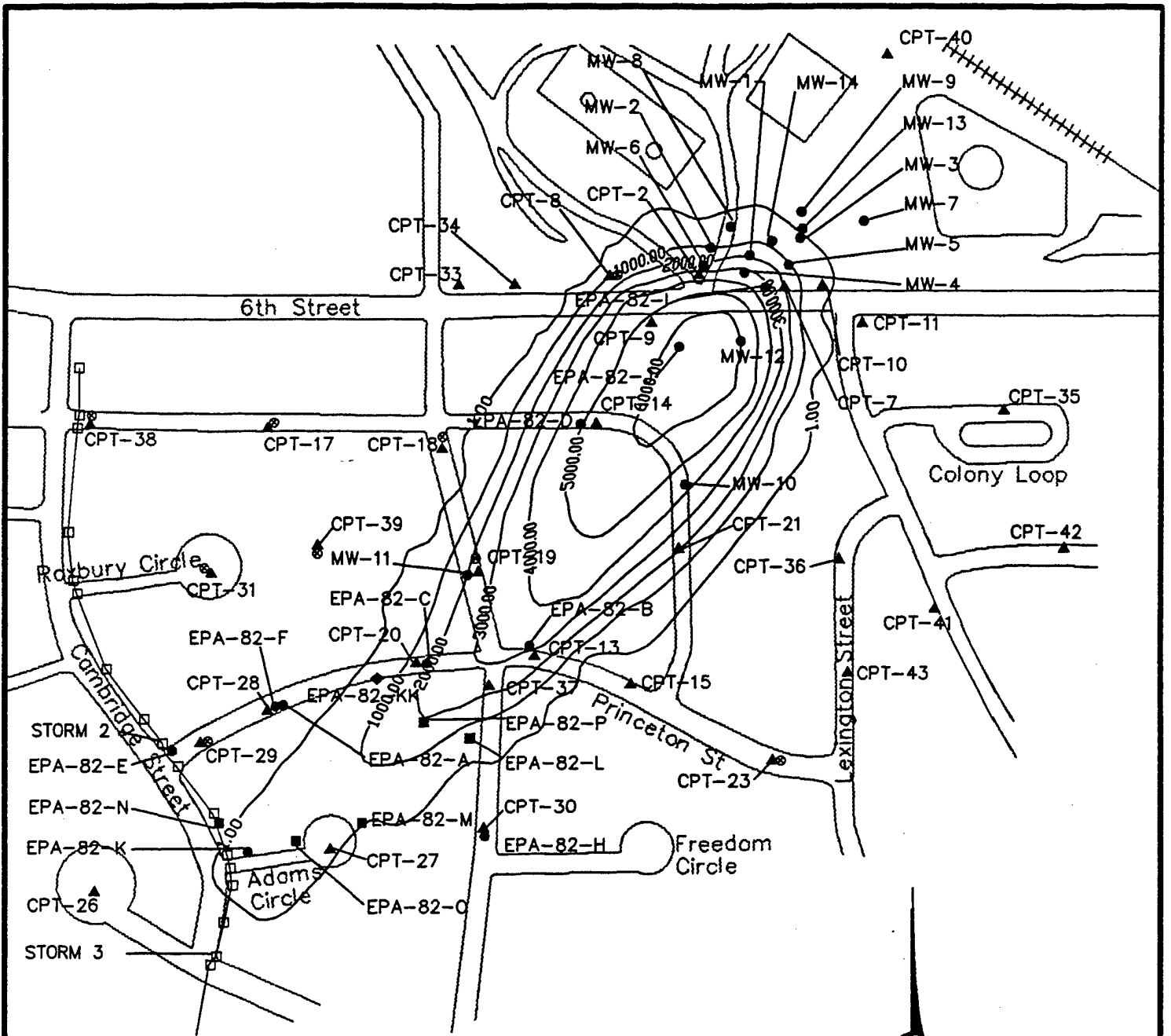

LEGEND

- CPT-26 ▲ CONE PENETROMETER TEST POINT/
PIEZOMETER
- MW-11 ● MONITORING WELL LOCATION
- AUGUST 1993 GEOPROBE SAMPLING
LOCATION
- STORM DRAIN SURVEY LOCATION
- EPA-82-M ■ JULY 1994 GEOPROBE SAMPLING
LOCATION
- EPA-82-KK ◆ JULY 1994 SOIL BORING LOCATION
- 1 — LINE OF EQUAL TOTAL BTEX
CONCENTRATION (µg/L)

CONTOUR INTERVAL = 1,000 µg/L

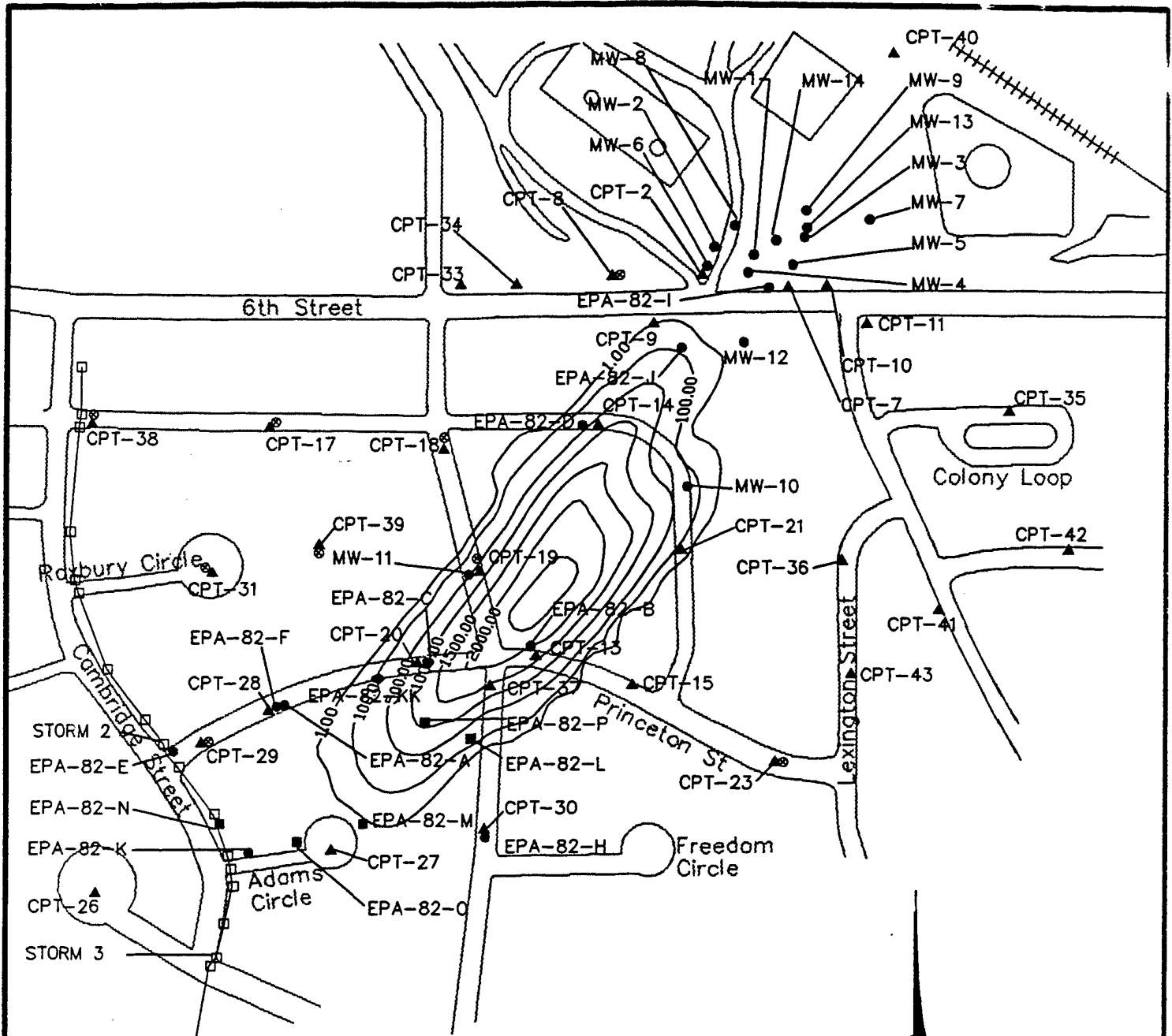

FIGURE 5.13
MODEL RESULTS
TOTAL DISSOLVED BTEX
15% ANNUAL LNAPL REMOVAL
T=1 YEAR

UST Site 870
Intrinsic Remediation EE/CA
Hill Air Force Base, Utah

PARSONS
ENGINEERING SCIENCE, INC.

Denver, Colorado



LEGEND

- CPT-26 ▲ CONE PENETROMETER TEST POINT/PIEZOMETER
- MW-11 ● MONITORING WELL LOCATION
- AUGUST 1993 GEOPROBE SAMPLING LOCATION
- STORM DRAIN SURVEY LOCATION
- EPA-82-M ■ JULY 1994 GEOPROBE SAMPLING LOCATION
- EPA-82-KK ◆ JULY 1994 SOIL BORING LOCATION
- 1 — LINE OF EQUAL TOTAL BTEX CONCENTRATION (µg/L)

CONTOUR INTERVAL = 500 µg/L



FIGURE 5.14
MODEL RESULTS
TOTAL DISSOLVED BTEX
15% ANNUAL LNAPL REMOVAL
T=3 YEARS

UST Site 870
 Intrinsic Remediation EE/CA
 Hill Air Force Base, Utah

PARSONS
ENGINEERING SCIENCE, INC.
 Denver, Colorado

5.9 CONCLUSIONS

Contaminant fate and transport at UST Site 870 was simulated using the finite-difference ground water model Bioplume II. Model results suggest that BTEX contamination may possibly migrate to Cambridge Street and the stormwater sewer running parallel to this street in all models. However, model simulations conducted during this project are extremely conservative for several reasons, including:

- 1) Aerobic respiration, denitrification, iron reduction, sulfanogenesis, and methanogenesis are all occurring at this site; however, only DO and nitrate are considered as electron acceptors during model simulations;
- 2) The stoichiometry used to determine the ratio between DO and nitrate-equivalent DO assumed that no microbial cell mass was produced during the reaction. As discussed in Section 4.3.2.1, this approach may be too conservative by a factor of three.
- 3) The highest DO concentration observed at the site was 6.3 mg/L. The highest DO concentration assumed during model simulations was 5.0 mg/L. In addition, the highest observed nitrate concentration observed at the site was 17 mg/L. The highest nitrate concentration assumed during model simulations was 10 mg/L. This nitrate concentration came only from upgradient, constant head cells; the majority of the area outside the plume was assumed to have nitrate concentrations of only 5 mg/L.
- 4) The lowest coefficient of retardation for benzene (1.29) was used for model simulations. Coefficient of retardation values for the other BTEX compounds range from 1.7 to 3.35. The use of the low coefficient of retardation tends to increase the distance traveled by the simulated BTEX plume, but provides a more accurate estimate of benzene transport.

The results of the Bioplume II modeling effort were used to help develop and compare ground water remedial options. This comparative analysis of remedial options is presented in Section 6.

SECTION 6

COMPARATIVE ANALYSIS OF REMEDIAL ALTERNATIVES

This section presents the development and comparative analysis of three ground water remedial alternatives for UST Site 870 at Hill AFB. The intent of this evaluation is to determine if intrinsic remediation is an appropriate and cost-effective remedial technology to consider when developing final remedial strategies for UST Site 870, especially when combined with other innovative and conventional remedial technologies.

Section 6.1 presents the evaluation criteria to be used to evaluate ground water remedial alternatives. Section 6.2 discusses the development of remedial alternatives to be considered as part of this demonstration project. Section 6.3 provides a brief description of each of these remedial alternatives. Section 6.4 provides a more detailed analysis of the remedial alternatives using the defined remedial alternative evaluation criteria. The results of this evaluation process are summarized in Section 6.5.

6.1 REMEDIAL ALTERNATIVE EVALUATION CRITERIA

The evaluation criteria used to identify the most appropriate remedial alternative for shallow ground water contamination at UST Site 870 were adapted from those recommended by the USEPA for selecting remedies for Superfund sites (OSWER Directive 9902.3). These criteria included (1) long-term effectiveness and permanence, (2) technical and administrative implementability, and (3) relative cost. The following sections briefly describe the scope and purpose of each evaluation criterion. This report does not include a complete discussion of applicable or relevant and appropriate requirements (ARARs) for the site. Rather, this report focuses on the potential use of intrinsic remediation and source reduction technologies to reduce BTEX concentrations within the shallow ground water to levels that pose an acceptable risk to human health or the environment.

6.1.1 Long-Term Effectiveness and Permanence

Each remedial technology or remedial alternative (which can be a combination of remedial technologies such as intrinsic remediation and institutional controls) is analyzed to determine

how effectively it will minimize ground water plume expansion so that ground water quality standards can be achieved at a downgradient POC. The expected technical effectiveness based on case histories from Hill AFB sites and other sites with similar conditions is also evaluated. The ability to minimize potential impacts to surrounding facilities and operations is considered. The ability of each remedial alternative to protect both current and potential future receptors from potential risks associated with site-related contamination in shallow ground water is qualitatively assessed by conservatively estimating if a potential exposure pathway involving ground water could be completed, either now or in the future. This evaluation criterion also included permanence and the ability to reduce contaminant mass, toxicity, and volume. Time to implementation and time until protection is achieved is described. Long-term reliability for providing continued protection, including an assessment of potential for failure of the technology and the potential threats resulting from such a failure, is also presented.

6.1.2 Implementability

The technical implementation of each remedial technology or remedial alternative was evaluated in terms of technical feasibility and availability. Potential shortcomings and difficulties in construction, operations, and monitoring are presented and weighed against perceived benefits. Requirements for any post-implementation site control, such as long-term monitoring and land use restrictions, are described. Details on administrative feasibility in terms of the likelihood of public acceptance and the ability to obtain necessary approvals is discussed.

6.1.3 Cost

The total cost (present worth) of each remedial alternative was estimated for relative comparison. An estimate of capital costs, and operating and post-implementation costs for site monitoring and land use controls is included. An annual inflation factor of 5 percent was applied in calculating the present value of operation, maintenance, and monitoring costs.

6.2 FACTORS INFLUENCING ALTERNATIVES DEVELOPMENT

Several factors were considered during the identification and screening of remedial technologies for addressing shallow ground water contamination at UST Site 870. Factors considered included the objectives of the natural attenuation demonstration program; contaminant, ground water and soil properties; present and future land use; and potential

exposure pathways. This section briefly describes each of these factors and how they were used to narrow the list of potentially applicable remedial technologies to the final remedial alternatives considered for UST Site 870.

6.2.1 Program Objectives

The intent of the Natural Attenuation (Intrinsic Remediation) Demonstration Program sponsored by AFCEE is to develop a systematic process for scientifically investigating and documenting naturally occurring subsurface attenuation processes that can be factored into overall site remediation plans. The objective of this program and the specific UST Site 870 study is to provide solid evidence of intrinsic remediation of dissolved-phase fuel hydrocarbon so that this information can be used to develop an effective ground water remediation strategy. A secondary goal of this multi-site initiative is to provide a series of regional case studies which demonstrate that natural processes of contaminant degradation can often reduce contaminant concentrations in ground water to below acceptable cleanup standards before completion of potential exposure pathways.

Because the objective of this program is to study natural processes in the saturated zone rather than in all contaminated media (e.g., unsaturated soil, or soil gas), technologies have been evaluated based on their potential impact on shallow ground water and phreatic soils. Technologies that can reduce vadose zone contamination and partitioning of contaminants into ground water have also been evaluated. Many of the source removal technologies evaluated in this section will also reduce soil and soil gas contamination, but it is important to emphasize that the remedial alternatives developed in this document are not intended to remediate all contaminated media. Additional program objectives set forth by AFCEE include cost-effectiveness and minimization of waste. Technologies that may meet these criteria include institutional controls, soil vapor extraction, bioventing, mobile LNAPL removal, biosparging, ground water extraction and treatment (air stripping), and intrinsic remediation. Soil excavation, slurry walls, sheet piling, carbon adsorption, *ex situ* biological or chemical treatment, and onsite/offsite disposal are not attractive technology candidates for this site.

6.2.2 Contaminant Properties

The site-related contaminants targeted as part of this demonstration at UST Site 870 are the BTEX compounds. The source of this contamination is weathered JP-4 jet fuel present as residual LNAPL in capillary fringe soil and as mobile LNAPL floating on the ground water surface within the source area of UST Site 870. The physiochemical characteristics of both

JP-4 and the individual BTEX compounds will greatly influence the effectiveness and selection of a remedial technology.

Petroleum hydrocarbon mixtures, such as JP-4 jet fuel, are comprised of over 300 compounds with different physiochemical characteristics. JP-4 is classified as a LNAPL with a liquid density of approximately 0.75 grams per milliliter (g/mL) at 20°C. Many compounds within JP-4 sorb very well to soil and are concentrated in the capillary fringe because the mixture is less dense than water. JP-4 is slightly soluble in water, with a maximum solubility of approximately 300 mg/L. JP-4 is also a primary substrate for biological metabolism. Simultaneous biodegradation of aliphatic, aromatic, and alicyclic hydrocarbons has been observed. In fact, mineralization rates of hydrocarbons in mixtures, such as JP-4, may be faster than mineralization of the individual constituents as a result of co-metabolic pathways (Jamison *et al.*, 1976; Perry, 1984).

The BTEX compounds are generally volatile, highly soluble in water, and adsorb less strongly to soil. These characteristics allow the BTEX compounds to leach more rapidly from contaminated soil into ground water and migrate as dissolved-phase contamination (Lyman *et al.*, 1992). All of the BTEX compounds are highly amenable to *in situ* degradation by both biotic and abiotic mechanisms.

Benzene is very volatile, with a vapor pressure of 76 millimeters of mercury (mm Hg) at 20°C and a Henry's Law Constant of approximately 0.0054 atmosphere-cubic meter/mole (atm-m³/mole) at 25°C (Hine and Mookerjee, 1975; Jury *et al.*, 1984). The solubility of benzene in water at 20°C has been reported to be 1,780 mg/L (Verschueren, 1983). Benzene is normally biodegraded to carbon dioxide with catechol as a short-lived intermediate (Hopper, 1978; Ribbons and Eaton, 1992).

Toluene is also volatile, with a vapor pressure of 22 mm Hg at 20°C and a Henry's Law Constant of about 0.0067 atm-m³/mole at 25°C (Pankow and Rosen, 1988; Hine and Mookerjee, 1975). Toluene sorbs more readily to soil media relative to benzene, but is still very mobile. The solubility of toluene in water at 20°C is approximately 515 mg/L at 20°C (Verschueren, 1983). Toluene has been shown to degrade to pyruvate, caetaldehyde, and completely to carbon dioxide via the intermediate catechol (Hopper, 1978; Wilson *et al.*, 1986; Ribbons and Eaton, 1992).

Ethylbenzene has a vapor pressure of 7 mm Hg at 20°C and a Henry's Law Constant of 0.0066 atm-m³/mole (Pankow and Rosen, 1988; Valsaraj, 1988). Ethylbenzene sorbs more

strongly to soils than benzene but less strongly than toluene (Abdul *et al.*, 1987). Ethylbenzene is also less soluble than benzene and toluene in water at 152 mg/L at 20°C (Verschueren, 1983; Miller *et al.*, 1985). Ethylbenzene ultimately degrades to carbon dioxide via its intermediate 3-ethylcatechol (Hopper, 1978; Ribbons and Eaton, 1992).

The three xylene isomers have vapor pressures ranging from 7 to 9 mm Hg at 20°C and Henry's Law Constants of between 0.005 and 0.007 atm-m³/mole at 25°C (Mackay and Wolkoff, 1973; Hine and Mookerjee, 1975; Pankow and Rosen, 1988). Of all of the BTEX compounds, xylenes sorb most strongly to soil, but still can leach from soil into the ground water (Abdul *et al.*, 1987). Xylenes have water solubilities of 152 to 160 mg/L at 20°C (Bohon and Claussen, 1951; Mackay and Shiu, 1981; Isnard and Lambert, 1988). Xylenes can degrade to carbon dioxide via pyruvate carbonyl intermediates (Hopper, 1978; Ribbons and Eaton, 1992).

Based on these physiochemical characteristics, intrinsic remediation, soil vapor extraction, bioventing, biosparging, ground water extraction, and air stripping technologies could all be effective at destroying, collecting, and treating BTEX contaminants at UST Site 870.

6.2.3 Site-Specific Conditions

Two general categories of site-specific characteristics were considered in identifying remedial technologies to comparatively evaluate as part of this demonstration project. The first category considered was physical characteristics such as ground water depth, gradient, and flow direction, and soil type, and their influence on the types of remedial technologies most appropriate for the site. The second category involved assumptions about future land use and potential exposure pathways. Each of these site-specific characteristics have influenced the selection of remedial alternatives included in the comparative evaluation.

6.2.3.1 Ground Water and Soil Characteristics

Site geology and hydrogeology will have a profound effect on the transport of contaminants and the effectiveness and scope of required remedial technologies at a site. Hydraulic conductivity is perhaps the most important aquifer parameter governing ground water flow and contaminant transport in the subsurface. The velocity of the ground water and dissolved-phase contamination is directly related to the hydraulic conductivity of the saturated zone. Rising-head slug tests completed at UST Site 870 indicate a relatively high hydraulic conductivity within and downgradient of the source area and dissolved-phase BTEX plume. Estimated values ranged from 1.67×10^{-2} to 8.31×10^{-3} cm/s. These high values are

characteristic of sandy materials (see Sections 4 and 5 of this report). The high hydraulic conductivity of shallow sediments at this site directly influences the fate and transport of contaminants. The shallow ground water plume has migrated rapidly, increasing the areal extent of contamination (i.e., plume expansion) but decreasing the average concentration within the aquifer via dilution and increased biodegradation.

Although high hydraulic conductivity can result in plume expansion and migration, this same characteristic will also enhance the effectiveness of other remedial technologies, such as ground water extraction, biosparging, and intrinsic remediation. For example, it should be less expensive and time-consuming to capture and treat the contaminant plume using a network of extraction wells in areas of high hydraulic conductivity than to implement this technology in aquifers with low hydraulic conductivity. Contaminant recovery may also be maximized when contaminants are not significantly sorbed and retarded by phreatic soil. The relatively low TOC content of Hill AFB aquifer materials (<0.094 percent) should tend to minimize sorption and increase the mobility of all BTEX compounds. The effectiveness of biosparging may also be increased in highly conductive aquifers because of reduced entry pressures and increased sparging well radius of influence. Greater hydraulic conductivity also increases the amount of contaminant mass traveling through the biosparging network. The DO introduced by biosparging can also be utilized effectively to aerobically biodegrade the dissolved contaminant mass.

The rapid movement of contaminants within the subsurface away from the source will also increase the effectiveness of natural biodegradation processes by distributing the contaminant mass into areas enriched with electron acceptors. To satisfy the requirements of indigenous microbial activity and intrinsic remediation, the aquifer must provide an adequate and available carbon or energy source, electron acceptors, essential nutrients, proper ranges of pH, temperature, alkalinity, salinity, and redox potential.

Data collected as part of the field work phase of this demonstration project and described in Sections 3 and 4 of this document, indicate that UST Site 870 is characterized by an adequate and available carbon/energy source, electron acceptors, and essential nutrients to support measurable biodegradation of JP-4 contamination by indigenous microorganisms. Both DO and nitrate represent significant sources of electron acceptor capacity for the biodegradation of BTEX compounds in ground water at the site. Further, because fuel-hydrocarbon-degrading microorganisms have been known to thrive under a wide range of temperature and pH conditions (Freeze and Cherry, 1979), the physical and chemical

conditions of the ground water and phreatic soil at UST Site 870 are not likely to inhibit microorganism growth.

Fuel hydrocarbon-degrading microorganisms are ubiquitous, and as many as 28 hydrocarbon-degrading isolates (bacteria and fungi) have been discovered in different soil environments (Davies and Westlake, 1977; Jones and Eddington, 1968). Indigenous microorganisms have a distinct advantage over microorganisms injected into the subsurface to enhance biodegradation as indigenous microorganisms are well adapted to the physical and chemical conditions of the subsurface in which they reside (Goldestein *et al.*, 1985). Microbe addition was not considered a viable remedial technology for UST Site 870.

6.2.3.2 Potential Exposure Pathways

An exposure assessment identifies the potential human and ecological receptors that could potentially come into contact with site-related contamination and the pathways through which these receptors might be exposed. To have a complete exposure pathway, there must be a source of contamination, a potential mechanism(s) of release, a pathway of transport to an exposure point, an exposure point, and a receptor. If any of these elements do not exist, the exposure pathway is considered incomplete, and receptors cannot come into contact with site-related contamination. Evaluation of the potential long-term effectiveness of any remedial technology or remedial alternative as part of this demonstration project includes determining if the approach will be sufficient and adequate to minimize plume expansion so that potential exposure pathways involving shallow ground water are incomplete.

Assumptions about current and future land use at a site form the basis for identifying potential receptors, potential exposure pathways, reasonable exposure scenarios, and appropriate remediation goals. USEPA (1991) advises that the land use associated with the highest (most conservative) potential level of exposure and risk that can reasonably be expected to occur should be used to guide the identification of potential exposure pathways and to determine the level to which the site must be remediated. The source area consists of an industrial fuel storage and office facilities associated with mission support services. Warehouses, offices, and other large structures are located to the east and west of UST Site 870. A portion of the Patriot Hills Base Housing Area is located to the south and southwest of the source area. The ground water plume originating from UST Site 870 is migrating to the southwest, and has impacted shallow ground water underlying this residential area. Hill AFB elementary school is located immediately southwest of the housing area on the base's

southwestern property boundary. Thus, the current land use within and downgradient of the contaminant plume is both industrial and residential.

Under reasonable current land use assumptions, potential receptors include both worker and residential populations. It is unlikely that workers could be exposed to site-related contamination in phreatic soils or shallow ground water unless this material was removed during future construction, excavations or remedial activities. Utility workers could be exposed to shallow ground water contamination if the plume migrates to and discharges into the stormwater sewer located along Cambridge Street. Shallow ground water is not currently used to meet industrial demands at Hill AFB. All onbase water demands are met by deep supply wells and/or from water piped in from the nearby Weber Basin Water Conservancy District. Exposure pathways involving other environmental media such as shallow soils and soil gas in the source area were not considered as part of this project, but should be considered in overall site remediation decisions.

Because of the depth of ground water (>5 feet), current residents should not be exposed to site-related contamination in ground water and phreatic soil under normal exposure conditions appropriate for the site. The most conservative exposure assumption involving ground water would involve uncontrolled or domestic use of ground water as a potable water supply. Although this exposure scenario can be an important consideration in deciding whether or not to take action at a site, it is not reasonable under current land use conditions. As noted previously, shallow ground water is not used to meet domestic potable water demands at Hill AFB at this time. Hill AFB officials could apply land use restrictions or institutional controls in the residential area to prevent residential use of ground water. It is possible that residents could be directly exposed to shallow ground water contamination at the stormwater sewer located along Cambridge Street as ground water may surface at this location. Potential current exposure pathways involving other environmental media such as soil gas beneath residential units were not considered as part of this demonstration. Other studies have addressed the potential of soil gas and have determined that pathways to residential areas are incomplete.

Assumptions about hypothetical future land uses must also be made to ensure that the remedial technology or alternative considered for shallow ground water at the site is adequate and sufficient to provide long-term protection. No changes in land use are anticipated in the foreseeable future. Use of the residential land use assumption is the most conservative (health-protective). Thus, potential future receptors include both worker and residential populations. The potential future exposure pathways involving workers are identical to those under current conditions provided shallow ground water is not used to meet industrial water

demands. The potential future exposure pathways involving residents will also be identical to current conditions if Hill AFB can effectively restrict shallow ground water use in all areas potentially affected by contamination from UST Site 870. In summary, the use of the intrinsic remediation technology at this site will require that the source area be maintained as industrial property and that restrictions on ground water use be enforced in areas downgradient of UST Site 870 to the Cambridge Street stormwater sewer. If source removal technologies such as soil vapor extraction, bioventing, mobile LNAPL recovery, biosparging, or ground water pump and treat are implemented, or expanded, they will also impact the short- and long-term land use options and will require some level of institutional control during and following remediation.

6.2.3.3 Remediation Goals for Shallow Ground Water

The stormwater sewer located along Cambridge Street has been identified as the most likely point of exposure for migrating contamination to impact human or ecological receptors. Migration to and discharge of contaminated shallow ground water into the stormwater system could complete an exposure pathway to human or ecological receptors via dermal contact or possible ingestion. The exceeding of Federal MCLs in the stormwater sewer near the intersection of Cambridge Street and Yorktown Street [proposed long-term monitoring (LTM) point], would trigger contingency sampling downgradient of the intersection at the outfall of the stormwater sewer near Pond 5. The stormwater sewer outfall into Pond 5 is an accessible and well-defined location for contingency monitoring and for demonstrating compliance with protective ground water quality standards (Federal MCLs).

This remedial strategy would be consistent with remediation requirements set forth by the State of Utah. The State recognizes that compliance with promulgated, single-point remediation goals is not necessary if site-related contamination does not pose a threat to human health or the environment (i.e., the exposure pathway is incomplete). Thus, the magnitude of required remediation in areas that can and will be placed under institutional control is different from the remediation that is required in areas that may be available for unrestricted use. This means that viable remedial alternatives, which includes long-term restrictions on shallow ground water use, must be able to achieve concentrations that minimize plume migration and expansion and potential human risk associated with ground water contact. The remediation goal for shallow ground water impacting the Cambridge Street stormwater sewer is attainment of federal MCLs for each of the BTEX compounds, as listed in Table 6.1. Although it is unlikely that stormwater would be ingested by humans, this level of long-term protection is appropriate for a residential area.

TABLE 6.1
POINT-OF-COMPLIANCE REMEDIATION GOALS
UST SITE 870 INTRINSIC REMEDIATION EE/CA
HILL AFB, UTAH

Compound	Federal MCLs ($\mu\text{g/L}$)
Benzene	5
Toluene	1,000
Ethylbenzene	700
Total Xylenes	10,000

In summary, available data indicate that no potential exposure pathway involving shallow ground water is complete under current conditions, with the exception of soil gas emanating from the ground water to within 4 feet of the surface. The exposure route for soil gas was identified in a vapor exposure assessment performed in other site characterization studies (Gemperline, written communication, 1995). Although an exposure pathway to the surface is completed from BTEX contamination volatilizing from ground water, human risk was calculated to be inconsequential. Other than soil gas, no potential exposure pathway involving shallow ground water will be complete under future land use assumptions provided use of ground water as a potable or industrial source of water is prohibited by institutional controls within and downgradient of the source area to the Cambridge Street stormwater sewer. Thus, institutional controls are likely to be a necessary component of any ground water remediation strategy for this site. The required duration of these institutional controls may vary depending on the effectiveness of any remedial technology at reducing contaminant mass and concentrations in the ground water. If Federal MCLs are exceeded at the proposed LTM well location at Cambridge Street and Yorktown Street (positioned between the ground water plume and the stormwater sewer), a contingency sampling point will be taken at the Cambridge Street stormwater discharge near Pond 5. If Federal MCLs are exceeded in the contingency sampling point, remediation of stormwater will be required to prevent pathway completion.

6.2.4 Summary of Remedial Technology Screening

Several remedial technologies were identified and screened for use in reducing the source of BTEX and for treating the shallow ground water at UST Site 870. Table 6.2 identifies the initial remedial technologies considered for this demonstration and those retained for more detailed analysis. Screening was conducted systematically by considering the objectives of the AFCEE intrinsic remediation demonstration, the physiochemical properties of BTEX compounds, and other site-specific characteristics such as hydrology, land use assumptions,

TABLE 6.2

INITIAL TECHNICAL IMPLEMENTABILITY SCREENING OF
 TECHNOLOGIES AND PROCESS OPTIONS FOR GROUND WATER REMEDIATION
 UST SITE 870 INTRINSIC REMEDIATION EE/CA
 HILL AFB, UTAH

General Response Action	Technology Type	Process Option	Implementability	Retain
Long-Term Monitoring	Periodic Ground Water Monitoring	Confirmation Wells	Many existing wells are available to confirm the progress of remediation.	Yes
		Point-of-Compliance Wells	Sufficient distance exists between the plume and point-of-compliance to locate several wells.	Yes
Institutional Controls	Ground Water Use Control	Land Use Control/Regulate Well Permits	Plume area is currently within the base boundary and land-use and ground water use are under base jurisdiction.	Yes
		Seal/Abandon Existing Wells	No production wells are known to exist in the existing or predicted plume area.	No
		Point-of-Use Treatment	No ground water is extracted from the plume area for any use.	No
		Meetings/Newsletters	Base public relations and environmental management offices have many information avenues to inform workers and residents.	Yes
Containment of Plume	Hydraulic Controls	Passive Drain Collection	Existing stormwater drain near Cambridge Street partially intercepts ground water. Drain could be expanded.	Yes
		Minimum Pumping/Gradient Control	A line or semicircle of vertical pumping wells could be located along the leading edge of plume to intercept and halt the advance of the plume.	Yes
		Slurry Walls/Grout Curtains	Requires significant disruption of a residential area.	No
Physical Controls	Reactive/Semi-Permeable Barriers	Sheet Piling	Requires significant disruption of a residential area.	No
		Biologically Active Zones	Natural biodegradation of BTEX compounds can be stimulated by allowing contaminated ground water to flow through an aquifer zone which has enhanced oxygen and nutrient conditions.	Yes

TABLE 6.2 (Continued)

INITIAL TECHNICAL IMPLEMENTABILITY SCREENING OF
TECHNOLOGIES AND PROCESS OPTIONS FOR GROUND WATER REMEDIATION
UST SITE 870 INTRINSIC REMEDIATION EE/CA
HILL AFB, UTAH

General Response Action	Technology Type	Process Option	Implementability	Retain
In Situ Treatment	Biological	Oxygen and Nutrient Enhanced Biodegradation	Differs from biologically active zone in that oxygen and nutrients are injected upgradient of plume and allowed to migrate downgradient. In theory, this method can more rapidly reduce higher BTEX concentrations in and immediately downgradient of the source area.	Yes
	Chemical/Physical	Intrinsic Remediation	A combination of natural biological, chemical, and physical removal mechanisms which occur to varying degrees on every site. Ground water sampling at UST Site 870 indicates that this is a major, ongoing remediation process.	Yes
Aboveground Ground Water Treatment	Ground Water Extraction	Air Sparging (Volatilization)	Injection of air into contaminated aquifer creating a mass transfer of BTEX into air bubbles and into vadose zone. Limited radius of influence and short-circuiting are common problems.	No
		Vertical Pumping Wells	Entire ground water plume is pumped by installing numerous wells with submersible pumps. High cost and major disruption to residential area.	No
	Downgradient Horizontal Drains	See Passive Drain Collection.	Yes	
	Bioreactors	High flow rates require excessive retention times and large reactors. BTEX is often volatilized in these systems.	No	
	Chemical/Physical	Air Stripping	Cost-effective technology for removing varying concentrations of BTEX at higher flow rates. Potential permitting for air emissions.	Yes
		Activated Carbon	Cost prohibitive for more concentrated BTEX. Creates a carbon disposal problem.	No
	UV/Ozone Reactors	High flow rates require excessive retention times and large, expensive reactors.	No	

TABLE 6.2 (Continued)

**INITIAL TECHNICAL IMPLEMENTABILITY SCREENING OF
TECHNOLOGIES AND PROCESS OPTIONS FOR GROUND WATER REMEDIATION
UST SITE 870 INTRINSIC REMEDIATION EE/CA
HILL AFB, UTAH**

General Response Action	Technology Type	Process Option	Implementability	Retain
Aboveground Treatment	Direct Discharge to Industrial Waste Water Treatment Plant (IWWTP)	IWWTP	Viable option when an IWWTP is available and capable of handling BTEX and hydraulic loading.	Yes
			Viable option when access to industrial sewer exists and hydraulic loading is acceptable.	Yes
Treated Ground Water Disposal	Discharge to IWWTP or Sanitary Sewer	Sanitary Sewer	Viable option when access to sanitary sewer exists and hydraulic loading is acceptable.	Yes
		Vertical Injection Wells	Not recommended due to clogging and high maintenance.	No
		Injection Trenches	Less clogging than wells but still require large trenches and can be subject to injection well permitting.	Yes
Source Removal/Soil Remediation	Discharge to Surface Waters Mobile LNAPL Recovery	Storm Drains	Viable option but generally requires NPDES or other discharge permit.	Yes
		Dual-Pump Systems	Best suited for sites with >1 foot mobile LNAPL where aboveground ground water treatment already exists	No
		Skimmer Pumps/Bailers/Wicks	Best suited for sites with <1 foot mobile LNAPL where ground water pumping is undesirable.	Yes
		Total Fluids Pumping	Best suited for sites with thin saturated zones where excessive ground water will not be pumped.	Yes
		Bioslurping	Combined vapor extraction, bioventing, and mobile LNAPL recovery system has been operated at the site with limited success.	Yes
Excavation/Treatment	Biological Landfarming	Deep excavation is not feasible at this site due to surface structures.	No	

TABLE 6.2 (Concluded)
 INITIAL TECHNICAL IMPLEMENTABILITY SCREENING OF
 TECHNOLOGIES AND PROCESS OPTIONS FOR GROUND WATER REMEDIATION
 UST SITE 870 INTRINSIC REMEDIATION EE/CA
 HILL AFB, UTAH

General Response Action	Technology Type	Process Option	Implementability	Retain
	Excavation/ Treatment (cont'd)	Thermal Desorption	Deep excavation is not feasible at this site due to surface structures.	No
	<i>In Situ</i>	Bioventing	Air injection to stimulate biodegradation of fuel residuals. System currently operating in source area.	Yes
		Soil Vapor Extraction	Vapor extraction has been successfully implemented at other Hill AFB sites. Requires expensive off-gas treatment.	Yes

potential exposure pathways, and appropriate remediation goals. All of these factors will influence the technical effectiveness, implementation, and relative cost of technologies for remediating shallow ground water underlying and migrating from the site.

The general response actions retained for consideration in the development of remedial alternatives include long-term monitoring institutional controls, *in situ* treatment (intrinsic remediation), plume containment, bioventing, soil vapor extraction, mobile LNAPL removal and ground water collection and aboveground treatment (air stripping) and ground water disposal in the base industrial waste water treatment plant (IWTP).

6.3 BRIEF DESCRIPTION OF REMEDIAL ALTERNATIVES

This section describes how remedial technologies retained from the screening process were combined into three remedial alternatives for UST Site 870. Sufficient information on each remedial alternative has been provided to facilitate a comparative analysis of effectiveness, implementability, and cost in Section 6.4.

6.3.1 Alternative 1 - Continued Mobile LNAPL Removal and Bioventing in Source Area, Intrinsic Remediation, Institutional Controls with Long-Term Monitoring

Mobile LNAPL recovery operations have been underway at UST Site 870 for over 1 year. To date, approximately 700 gallons of JP-4 have been recovered from one skimmer pump and 5 to 7 wells with sorbent wicks located in the source area. Limited bioventing is also underway in the source area. A two-well bioventing system is currently injecting air into the subsurface and providing oxygen to approximately 15,000 cubic yards of the most contaminated vadose soils. Under this alternative, existing mobile LNAPL removal and bioventing activities would be continued, but no additional source removal technologies would be employed. Because the area of remediation under this alternative is limited to soils north of Sixth Street and because LNAPL recovery is a slow process, it is estimated that a 5-percent annual reduction in source BTEX will occur with this alternative.

Intrinsic remediation is achieved when naturally occurring attenuation mechanisms bring about a reduction in the total mass of a contaminant in the soil or dissolved in ground water. Intrinsic remediation results from the integration of several subsurface attenuation mechanisms that are classified as either destructive or nondestructive. Destructive attenuation mechanisms include biodegradation, abiotic oxidation, and hydrolysis. Nondestructive attenuation mechanisms include sorption, dilution (caused by dispersion and infiltration), and volatilization. In some cases, intrinsic remediation will reduce dissolved-phase contaminant

concentrations below numerical concentration goals, thus protecting human health and the environment. Based on the existing evidence of intrinsic remediation described in Sections 4 and 5, these processes are occurring and will continue to reduce contaminant mass as the plume advances. Figures 5.9, 5.10, and 5.11 illustrate the projected BTEX plume migration and concentration reductions that should take place when 5 percent of the BTEX source is removed each year through limited mobile LNAPL recovery and bioventing. Based on model predictions, the BTEX plume will approach the Cambridge Street storm drain in approximately 1 to 4 years at concentrations exceeding 1 µg/L. During years 4 through 7, the Bioplume II model predicts that the combination of source reductions and intrinsic remediation within the BTEX plume will significantly reduce its size and concentration.

A 5-percent annual LNAPL recovery/reduction was selected as a reasonable removal rate of BTEX concentrations emanating from mobile LNAPL at the site. A 5-percent annual BTEX source recovery/reduction could accomplish this. The most important physical processes contributing to BTEX source weathering are volatilization and dissolution. The dissolution of BTEX compounds from LNAPL is accomplished through interfacial dissolution at the fuel/water interface and dissolution into precipitation that is percolating downward.”

The 5-percent annual BTEX loss was selected for comparison purposes only, and is not intended to reflect an actual rate of BTEX source reduction. On the basis of previous fuel-spill investigations in similar soils at Wurtsmith AFB, BTEX constituents in mobile LNAPL decreased at rates exceeding 70 percent per year through natural weathering (Parsons ES, 1995). Approximately 1,500 gallons of JP-4 released into a shallow, sandy aquifer at Wurtsmith AFB in October 1988 had weathered to low residual-phase concentrations (<150 µg/L) without measurable free-product by June 1991. BTEX compounds in LNAPL are being similarly weathered at UST 870, as seen by a decrease in BTEX concentrations in LNAPL over time (Table 4.1). The LNAPL sample taken from MW-10 exhibited a 70-percent loss of BTEX constituents relative to fresh LNAPL (JP-4). Hence, the partitioning strength of BTEX compounds in LNAPL contamination is diminishing not only from engineered removal (bioslurpers), but also from natural weathering. Regardless of the value used to estimate annual BTEX source reductions, the calibrated model predicts that groundwater will not migrate past the base boundary, with the front of the plume stabilizing near Cambridge Street (assuming current conditions are not compromised with further fuel spills). The BTEX plume is expected to disappear from overwhelming natural attenuation mechanisms once BTEX source concentrations are reduced to approximately 50 percent of their current concentration.

Implementation of Alternative 1 would require the use of institutional controls such as land use restrictions and long-term monitoring. Land use restrictions may include placing long-term restrictions on soil excavation within the source area and ground water well installations within and downgradient of the source area. The intent of these restrictions would be to reduce potential receptor exposure to contaminants by legally restricting activities within areas affected by site-related contamination.

As a minimum, ground water monitoring would be conducted twice annually as part of this remedial technology to evaluate the progress of natural attenuation processes. Based on the potential plume migration, the Cambridge Street stormwater sewer could be impacted by BTEX at concentrations approaching Federal MCLs. Section 7 discusses the proposed locations of LTM wells, a contingency sampling point located at the stormwater sewer outfall, and three POC wells that would be used to monitor and identify the potential migration of contaminated ground water into or beyond the Cambridge Street stormwater sewer. These wells would be screened across the first 5 to 10 feet of the shallow aquifer to provide some early warning of the advance of the plume toward the base boundary. The stormwater discharge from the Cambridge Street sewer would act as the contingency sampling point that will be sampled only if Federal MCLs are first exceeded at the Cambridge Street and Yorktown Street LTM location. This contingency sampling point will be used to verify the hydraulic connection between the shallow ground water and this potential pathway. Detection of BTEX in excess of Federal MCLs at the POC wells or stormwater discharge point (contingency sampling point) would trigger a reevaluation of remedial options to ensure that MCLs are not exceeded at the stormwater discharge point.

Public education on the selected alternative will be developed to inform base personnel and residents of the scientific principles underlying source reduction and intrinsic remediation. This education could be accomplished through public meetings, presentations, press releases, and posting of signs where appropriate. Periodic site reviews could also be conducted every year using data collected from the long-term ground water monitoring program. The purpose of these periodic reviews would be to evaluate the extent of contamination, assess contaminant migration and attenuation over time, document the effectiveness of institutional controls at the site, and reevaluate the need for additional remedial actions at the site.

6.3.2 Alternative 2 - Continued Mobile LNAPL Recovery and Bioventing, Intrinsic Remediation, Institutional Controls with Long-term Ground Water Monitoring, Stormwater Treatment

This alternative is identical to Alternative 1 except that it includes a provision for stormwater treatment if MCLs are exceeded at the stormwater discharge point (contingency

sampling point). Construction of a passive ground water collection trench was considered but deemed unnecessary given the very low concentration of BTEX expected near the stormwater sewer. Aboveground treatment of stormwater using a portable sparging tank will be included to ensure that BTEX concentrations in excess of MCLs do not pose a threat to human or ecological receptors at the stormwater discharge pond. Stormwater would be treated using a simple air sparging tank that would strip BTEX compounds from the stormwater prior to discharge to the pond. This alternative would supplement intrinsic remediation by ensuring that any ground water with BTEX concentrations exceeding Federal MCLs is treated before it completes a potential exposure pathway. As with Alternative 1, institutional controls and long-term monitoring would be required. The presence of BTEX in excess of Federal MCLs at POC wells could also trigger the need for additional ground water remediation downgradient of Cambridge Street to ensure contaminated ground water does not migrate off-base.

A low-flow weir would be constructed at the stormwater discharge point to convey stormwater through the sparge tank at rates the system is capable of handling. In the event that stormwater runoff exceeds the capacity of the weir (and the sparge tank system), the excess stormwater will be discharged directly to collection ponds without treatment. Although excess water would not be treated, the anticipated risk of BTEX contamination would be very low due to dilution of the BTEX compounds.

6.3.3 Alternative 3 - Expanded Mobile LNAPL Removal and Bioventing, Intrinsic Remediation, Institutional Controls and Long-Term Monitoring

This remedial alternative couples several remedial technologies to more aggressively address both mobile LNAPL and residual LNAPL contamination in soil and ground water at UST Site 870. The objective of this alternative would be to more rapidly reduce the partitioning of BTEX from mobile LNAPL and soils and to ensure that no contaminated ground water migrated into or beyond the Cambridge Street stormwater sewer. The source removal technologies considered for mobile LNAPL and residual LNAPL contamination in the soil and capillary fringe are mobile LNAPL recovery using LNAPL recovery pumps, soil vapor extraction, and bioventing.

A maximum of 4 feet of apparent floating mobile LNAPL was discovered at UST Site 870 during recent field investigations. Current mobile LNAPL recovery efforts are focused in the spill source area, although the estimated areal extent of mobile LNAPL contamination at the site extends downgradient of this area (Section 4). More intensive mobile LNAPL recovery could be accomplished by installing conventional skimmer pumps in available 4-inch ground

water monitoring wells containing mobile LNAPL. As a supplement to these pumps, it would also be necessary to install additional product recovery wells and total fluid recovery pumps downgradient of current product recovery wells. Any recovered product would be separated in an oil/water separator, and transported offsite for recycling or disposal in a permitted treatment, storage, and disposal facility for waste oil. It was assumed that contaminated water could be transported to the base industrial wastewater sewer system.

The leading edge of the migrating mobile LNAPL area shown in Figure 4.1 would be targeted for mobile LNAPL recovery. For estimating purposes five, 6-inch diameter mobile LNAPL recovery wells would be installed in a line between CPT-14 and MW-10 to more rapidly remove this source of BTEX contamination. A total-fluids recovery system is recommended to remove LNAPL and small quantities of water from this area. It is important to note that even in optimum, coarse-grained soils, a 30- to 50-percent recovery of the spilled fuel is considered excellent.

Much of the remaining 50 to 70 percent of the fuel is more tightly occluded and bound in the micropore structure of the soil. Removal of this residual fuel can be accomplished using either soil vapor extraction or bioventing technologies. Bioventing is an *in situ* process where low-flow air injection is used to enhance the biodegradation of organic contaminants in subsurface soils. Soil vapor extraction focuses on rapidly removing the volatile fraction of fuels through extracting soil vapor at higher rates. Both technologies have been successfully applied at JP-4 contaminated sites on Hill AFB (Hinchee, 1993). Bioventing is generally the technology of choice because unlike soil vapor extraction, bioventing uses a low rate of air injection that does not create vapor emissions to the atmosphere. Utah strictly limits VOC emissions, and the cost of soil vapor extraction is nearly doubled when vapor treatment is required. Although bioventing has been selected for this alternative, special flux monitoring will be required if air injection is proposed for the capillary fringe contamination beneath the residential area.

Extensive pilot- and full-scale testing of the bioventing technology at Hill AFB has resulted in significant reductions in soil BTEX and TPH. At Site 388, JP-4 jet fuel biodegradation rates were estimated at 2,500 milligrams of TPH per kilogram of soil per year (ES, 1994). Based on an estimated 60-foot radius of oxygen influence observed at Site 388, construction of a bioventing system at UST Site 870 could require approximately 11 vertical vent wells to influence the estimated 120,000 square feet of area with BTEX-impacted soils exceeding 50 mg/Kg total BTEX. Four-inch-diameter wells could be used, and screened intervals would be installed over the thin contaminated soil interval just above the water table. A single 20-

horsepower blower system should be capable of supplying air (oxygen) to this soil volume. Operational emphasis would be placed on the destruction of BTEX compounds in the capillary fringe to significantly reduce this source of continuing ground water contamination.

Although bioventing is primarily used to address vadose (unsaturated) soil contamination, field demonstrations have shown an increase in DO concentration levels in phreatic soil and ground water (Barr, 1993). The increase in DO concentrations within the capillary fringe and ground water can facilitate biodegradation of dissolved hydrocarbon contamination.

In order to estimate the potential impact of this more intensive source removal on the downgradient plume expansion, a 15-percent per year reduction in the BTEX source term was factored into the Bioplume II model. This assumes that the more extensive mobile LNAPL removal and bioventing systems will be able to remove BTEX three times faster than the current source removal rates assumed under Alternatives 1 and 2. Figure 5.13 illustrates the predicted BTEX plume migration after 3 years of more intensive source removal. The model predicts that after 3 years, BTEX concentration will approximately one-half of those encountered with Alternative 1 and 2 after the same 3-year period. Based on these model predictions, the combined effect of intensive source removal and intrinsic remediation would reduce the likelihood of BTEX migration in excess of Federal MCLs beyond the POC wells and into the Cambridge Street stormwater sewer. Under this scenario, the need for treatment of the stormwater discharge seems unlikely.

Although more intensive source removal would more rapidly decrease dissolved BTEX concentrations and accelerate intrinsic remediation, it would not eliminate the need for short-term institutional controls and long-term monitoring. The required time frame for institutional controls and long-term monitoring could be shortened by approximately 4 to 5 years if this alternative were implemented.

6.4 EVALUATION OF ALTERNATIVES

This section provides a comparative analysis of each of the three remedial alternatives based on the effectiveness, implementability, and cost criteria. A summary of this evaluation is found in Table 6.6 at the end of this section.

6.4.1 Alternative 1 - Continued Mobile LNAPL Removal and Bioventing in Source Area, Intrinsic Remediation, Institutional Controls with Long-Term Monitoring

6.4.1.1 Effectiveness

Section 5 of this document presents the results of the Bioplume II model completed to support the intrinsic remediation alternative at UST Site 870. The potential impacts of remaining mobile LNAPL on ground water contamination over time were incorporated into the model for this remedial alternative. Only the existing product recovery and bioventing systems in the spill area were included in this alternative because of the increasing cost and reduced efficiency of trying to recover a more dispersed mobile LNAPL layer in downgradient areas.

This assessment predicted that natural attenuation mechanisms will significantly limit contaminant migration and reduce contaminant mass and toxicity. However, the model predicted a potential exceedance of the Federal MCLs for BTEX at the POC wells (Figure 7.1) and a potential risk of exposure at the outfall of the Cambridge Street stormwater sewer. Because the Bioplume II model is based upon numerous conservative assumptions and does not fully account for the anaerobic biodegradation available due to sulfate and other electron acceptors, it is possible that BTEX concentrations in excess of Federal MCLs will never reach the POC wells or stormwater sewer. Semiannual ground water monitoring at the POC wells and LTM wells along the leading edge of the existing plume would be critical to ensuring the protectiveness of this alternative. Detection of BTEX above Federal MCLs at the proposed Cambridge Street and Yorktown Street intersection LTM well would require sampling at a contingency sampling point located at the outfall of the Cambridge Street stormwater sewer near Pond 5. This alternative would cease to be protective if the BTEX plume was intercepted by the stormwater sewer and contaminated ground water was subsequently discharged into the stormwater pond.

The effectiveness of this remedial alternative requires that excavations or drilling within the source area be limited to properly protected site workers. Long-term land use restrictions will be required to ensure that shallow ground water will not be pumped or removed for potable use within, and approximately 500 feet in all directions from, the existing BTEX plume. Existing health and safety plans should be enforced to reduce risks from operating existing source reduction technologies and from installing and monitoring additional POC wells.

Compliance with program goals is one component of the long-term effectiveness evaluation criterion. Alternative 1 will satisfy program objectives designed to promote intrinsic remediation as a component of site remediation and to scientifically document naturally occurring processes.

Alternative 1 is based on the effectiveness of naturally occurring processes that minimize contaminant migration and reduce contaminant mass over time and the effectiveness of institutional controls. As described earlier, an investigation of the potential effectiveness of naturally occurring processes at UST Site 870 using field data and the Bioplume II model has demonstrated that the BTEX plume will be significantly reduced in size and mass in 4 to 7 years. The maximum distance traveled by the plume could be slightly beyond the Cambridge Street stormwater sewer, however, the mass of the BTEX will be significantly reduced during that time so that the maximum concentration of BTEX reaching the stormwater sewer is below Federal MCLs. The sensitivity analysis completed on the Bioplume II model for this site (Section 5) suggests that even under the most conservative (i.e., worst-case) conditions, the naturally occurring processes at UST Site 870 should significantly reduce contaminant migration to a potential exposure point (the stormwater sewer located along Cambridge Street). Aside from the administrative concerns associated with long-term enforcement of long-term land use restrictions and long-term ground water monitoring programs, this remedial alternative should provide reliable, continued protection.

For cost comparison purposes, and based on Bioplume modeling results, it is assumed that source removal will continue for 8 years and that dissolved BTEX concentrations will exceed MCLs throughout the plume for approximately 8 years under Alternative 1. The 8-year time frame is a reasonable source removal goal based on predictions of successful source removal, both engineered and natural, that will approach, or exceed, 5 percent annually (Section 6.3.1). An additional 5 years of semi-annual ground water monitoring will be required to ensure that intrinsic remediation has uniformly reduced all BTEX compounds to levels below Federal MCLs, resulting in a total treatment/monitoring time of approximately 13 years.

6.4.1.2 Implementability

Alternative 1 is not technically difficult to implement. Continued operation of existing mobile LNAPL recovery and bioventing systems will require minimal new construction. Existing procedures for mobile LNAPL removal and recycling will be followed. Installation of POC ground water monitoring wells is a standard procedure at Hill AFB. Long-term management efforts will be required to ensure proper sampling procedures are followed. Periodic site reviews should be conducted to confirm the adequacy and completeness of long-term monitoring data and verify the effectiveness of this remediation approach. There may also be administrative concerns associated with long-term enforcement of ground water use restrictions. Future land use within the source area may be impacted by leaving contaminated

soil and ground water in place. Regulators and the public will have to be informed of the benefits and limitations of the intrinsic remediation option. Educational programs are not difficult to implement, and the initial regulatory reaction to this alternative has been positive.

6.4.1.3 Cost

The cost of Alternative 1 is summarized in Table 6.3. Capital costs are limited to the construction of three new POC wells. The estimated cost of maintaining existing mobile LNAPL recovery and bioventing systems for 8 years are included in the \$372,000 present-worth cost estimate for Alternative 1. Also included are the costs of maintaining institutional controls and long-term ground water monitoring for a total of 13 years. The total present worth of this alternative is most sensitive to the estimated time requirement for intrinsic remediation to reduce BTEX concentrations to below Federal MCLs. Costs could be reduced by changing from semiannual to annual monitoring after the plume begins to recede.

6.4.2 Alternative 2 - Continued Mobile LNAPL Recovery and Bioventing in Source Area, Intrinsic Remediation, Institutional Controls with Long-Term Ground Water Monitoring, Stormwater Treatment

6.4.2.1 Effectiveness

The effectiveness of Alternative 1 is enhanced under Alternative 2 by ensuring that if stormwater becomes contaminated, an air stripping unit will be installed to treat ground water to levels below federal drinking water MCLs before it is discharged to the stormwater pond. As stated in Section 6.3.2, the use of a stormwater air stripper would be contingent on BTEX concentrations exceeding MCLs at both the Cambridge Street and Yorktown Street intersection LTM well and the Cambridge Street stormwater sewer outfall contingency sampling location. Air stripping technologies, including sparging tanks, are proven and reliable systems for reducing BTEX compound concentrations in water by more than 95 percent. The use of a low-flow diversion weir to treat only more concentrated BTEX-contaminated stormwater will reduce the size and complexity of the air stripping system. This alternative also complies with the program goals because intrinsic remediation remains the predominant decontamination method at the site.

6.4.2.2 Implementability

The addition of a small stormwater treatment system at the stormwater discharge point near the stormwater pond does not present any unique implementation problems. A 230-volt power source and a concrete pad would be required to support the portable sparging tank system. Additional time would be required for base personnel to sample influent and effluent to the sparging tank. The use of a sparging tank will minimize maintenance time. Some

TABLE 6.3
ALTERNATIVE 1 - COST ESTIMATE
UST SITE 870 INTRINSIC REMEDIATION EE/CA
HILL AFB, UTAH

Capital Costs	Cost
Design/Construct Three POC Wells	\$12,000
Operation, Maintenance and Monitoring Costs (Annual)	Annual Cost
Operate and Maintain Existing Mobile LNAPL Recovery and Bioventing Systems (8 years)	\$18,000
Ground Water Monitoring (12 wells - Semiannually 13 Years)	\$12,000
Maintain Institutional Controls/Public Education (13 years)	\$6,000
Project Management (13 years)	\$8,000
Present Worth of Alternative 1^{a/}	\$372,000

a/ Based on I=5%

accumulation of iron and manganese sludge and biological sludge will occur in the tank. A properly designed tank will have a conical bottom to draw off sludge without interrupting the treatment process. Waste sludge should be nonhazardous.

The installation of POC wells, the institutional controls and long-term monitoring commitments described in Alternative 1 will also be implemented with this alternative. If BTEX exceeds Federal MCLs at POC wells, additional ground water remediation may be required to ensure that contaminated ground water is not migrating beyond the base boundary.

6.4.2.3 Cost

The cost of Alternative 1 will be increased by the stormwater treatment system and maintenance and monitoring of the system. Based on Bioplume II model predictions, the plume will begin to recede during the fourth year. For cost comparison purposes it is assumed that the stormwater treatment system will operate for 5 years to ensure that contaminated ground water is not discharged to the stormwater pond. As with Alternative 1,

source reduction technologies would continue for 8 years under Alternative 2. Annual long-term monitoring would continue for an additional 5 years to ensure that intrinsic remediation is reducing contaminant concentrations below MCLs throughout the plume. The estimated capital and operating costs of Alternative 2 are shown in Table 6.4. The total present worth cost of Alternative 2 is \$455,000.

6.4.3 Alternative 3 - Intensive Source Removal, Intrinsic Remediation, Institutional Controls and Long-Term Monitoring

6.4.3.1 Effectiveness

More intensive source removal coupled with intrinsic remediation and long-term monitoring should reduce the dissolved-phase BTEX plume concentrations and significantly reduce potential exposure at the Cambridge Street stormwater discharge. If a greater percentage of the mobile LNAPL could be removed and soil BTEX concentrations could be significantly reduced, the partitioning of BTEX into ground water would be reduced, thereby promoting a more rapid decrease in contaminant mass, mobility, and toxicity. It was assumed that mobile LNAPL removal and bioventing would continue for approximately 4 years. During these 4 years, the site model assumed that the total BTEX mass in the soil would be reduced by 60 percent and that average dissolved BTEX concentrations at the center of the plume would be reduced to less than 5 µg/L as a result of intrinsic remediation.

Conceptually, this 15-percent annual reduction in a BTEX source from mobile LNAPL will be obtained from both natural weathering and increased engineered removal. Natural weathering rates of BTEX compounds in mobile LNAPL under similar conditions can be substantial (Section 6.3.1). Similar weathering losses of JP-4 contamination are occurring at Site UST 870. The assumed 15-percent annual reduction of BTEX constituents in mobile LNAPL does not necessarily represent actual weathering rates, but show potential LNAPL reduction rates as a result of increased LNAPL removal along with natural weathering. More intensive source removal could help achieve protectiveness approximately 4 years sooner than that under Alternative 1. The model predicts that with more intensive source removal, the BTEX plume will be less concentrated approaching the Cambridge Street stormwater sewer, and this exposure pathway may not be completed.

Site workers would have to handle and be exposed to larger volumes of extracted mobile LNAPL. Bioventing in the source area and downgradient smear zones would be an effective

TABLE 6.4
ALTERNATIVE 2 - COST ESTIMATE
UST SITE 870 INTRINSIC REMEDIATION EE/CA
HILL AFB, UTAH

Capital Costs	Cost
Three POC Wells	\$12,000
Stormwater Treatment System	\$24,000
Operation, Maintenance and Monitoring Costs (Annual)	Annual Cost
Operate Existing Mobile LNAPL Recovery/Bioventing Systems (8 years)	\$18,000
Operate and Monitor Stormwater Treatment System (5 years)	\$14,000
Ground Water Monitoring (12 wells - Semiannually 13 Years)	\$12,000
Maintain Institutional Controls/Public Education (13 years)	\$6,000
Project Management (13 years)	\$8,000
Present Worth of Alternative 2^{a/}	\$455,000

a/ Based on I=5%.

method of reducing the BTEX which could partition into shallow ground water. The toxicity of the soil would also be more rapidly reduced. Bioventing has been shown to preferentially remove BTEX compounds and reduce toxicity in soils (Miller, 1993). If air injection is used beneath the residential area, additional monitoring will be required to ensure that vapors do not migrate upward into occupied buildings.

The more aggressive source removal component of this remedial alternative satisfies the statutory preference for using treatment to more rapidly reduce contaminant mobility and toxicity. Long-term natural attenuation processes will also reduce contaminant toxicity, mobility, and volume in ground water. Long-term land restrictions should be implemented to ensure that shallow ground water will not be available for use as a potable water source downgradient of the source area. A health and safety plan would be developed to mitigate

risks from installing and operating the expanded mobile LNAPL recovery and bioventing system, and installing and monitoring POC wells. Thus, this remedial alternative should also minimize contaminant migration and provide long-term protection.

Alternative 3 also satisfies the program objectives of demonstrating the potential effectiveness of intrinsic remediation for minimizing plume expansion and reducing BTEX mass and toxicity. However, this remedial alternative will result in the generation of additional mobile LNAPL, ground water, drill cuttings, and other wastes requiring treatment and/or disposal. Alternative 3 (intensive source removal, intrinsic remediation, and long-term monitoring) should provide reliable, continuous protection with little risk from temporary system failures.

6.4.3.2 Implementability

Installing and operating a more intensive mobile LNAPL recovery, and bioventing system to remove the source of BTEX contamination at UST Site 870 will present additional implementability concerns. Installation involves standard drilling practices for wells, and limited excavation for piping and manifold connections. Implementation in and around residential areas would be disruptive to residents and their yards. Mobile LNAPL recovery and bioventing equipment is available, and small systems are already in place in the UST Site 870 spill area. Extraction wells required for product recovery represent a well-developed technology that has been proven at numerous sites. Bioventing is an innovative technology that has been used effectively at other JP-4 contaminated sites at Hill AFB. Implementation of this remedial alternative would also require flux monitoring during bioventing startup to confirm that soil vapors are not transmitted upward into residential buildings. Annual *in situ* respiration testing is also required to verify that the system is working as expected. The technical and administrative implementability concerns associated with the intrinsic remediation and long-term monitoring component of this remedial alternative are identical to those discussed in Alternative 1, except the time frame is approximately 4 years shorter.

6.4.3.3 Cost

The total present worth of this alternative is estimated at \$782,000. The cost differential between Alternatives 2 and 3 is sensitive to the extent and duration of required LNAPL recovery, bioventing operations, and the accuracy of intrinsic remediation modeling results. Table 6.5 lists the costs for Alternative 3 based on a mobile LNAPL removal period of 4 years and a bioventing period of 4 years. During years 4 through 9, semiannual ground water

TABLE 6.5
ALTERNATIVE 3 - COST ESTIMATE
UST SITE 870 INTRINSIC REMEDIATION EE/CA
HILL AFB, UTAH

Capital Costs	Cost
Design/Construct 5 Mobile LNAPL Recovery Wells and Collection Systems	\$98,000
Design/Construct 11-Well Bioventing System	\$363,000
Design/Construct Three POC Wells	\$12,000
Operation, Maintenance and Monitoring Costs (Annual)	Annual Cost
Operate New Mobile LNAPL Recovery/ Bioventing Systems (4 years)	\$36,200
Ground Water Monitoring (12 wells - Semiannually Years 1-9)	\$12,000
Maintain - Institutional Controls/Public Education (9 years)	\$6,000
Project Management (9 years)	\$8,000
Present Worth of Alternative 3^{a/}	\$782,000

a/ Based on i=5%.

monitoring will be conducted to verify that intrinsic remediation is reducing dissolved BTEX contaminants to levels below MCLs.

6.5 RECOMMENDED REMEDIAL APPROACH

Three multicomponent alternatives have been evaluated for remediation of the shallow ground water at UST Site 870. Alternatives evaluated include two levels of source removal, intrinsic remediation with long-term monitoring, and an alternative which would treat stormwater if it contained benzene or other BTEX compounds in excess of MCLs. Table 6.6 summarizes the results of this evaluation based upon effectiveness, implementability and cost criteria. Based on this evaluation, the Air Force recommends Alternative 2 as the best combination of risk reduction and cost effectiveness to achieve RAOs for dissolved-phase BTEX in UST Site 870 ground water.

Only marginal reductions in plume migration and risk reduction will be achieved if more intensive source removal is applied to the downgradient smear zone. These marginal reductions will come at a significant increase in cost and significant disturbance to a residential area during additional mobile LNAPL recovery well and bioventing system construction. Based on all effectiveness criteria, Alternative 2 will make maximum use of intrinsic remediation to reduce plume migration and toxicity while providing the assurance that if MCLs are exceeded through contingency sampling at the stormwater discharge point, an effective treatment system can be rapidly installed to prevent completion of a conservative exposure pathway.

All of the remedial alternatives are implementable, however, Alternative 2 significantly minimizes potential disruptions to base housing residents and should be acceptable to the public and regulatory agencies because it is protective of human health and the environment. Implementation of Alternative 2 will require land use and ground water use controls to be enforced for approximately 8 to 13 years with semiannual ground water monitoring. The cost of Alternatives 1 and 2 could be reduced if annual ground water monitoring is implemented once the plume began to recede.

The final evaluation criterion used to compare each of the three remedial alternatives was cost. It is the opinion of the Air Force that the additional cost of Alternative 2 over Alternative 1 is justified by the additional protection it provides. In contrast, the additional cost of Alternative 3 can not be justified by the marginal reduction in treatment and monitoring time that is gained from more intensive source removal.

TABLE 6.6
SUMMARY OF REMEDIAL ALTERNATIVE EVALUATION
GROUND WATER REMEDIATION
UST SITE 870 INTRINSIC REMEDIATION EE/CA
HILL AFB, UTAH

Remedial Alternative	Effectiveness	Implementability	Present Worth Cost Estimate
Alternative 1 - Limited Source Removal - Intrinsic Remediation - Long-Term Monitoring	Continued mobile LNAPL removal and bioventing will gradually remove BTEX source. Contaminant mass, volume and toxicity will be significantly reduced over next seven years. MCL for benzene could be exceeded at POC.	Readily implementable. Long-term management, ground water use controls and monitoring required for an estimated 13 years. Minimal exposure of site workers if excavation is carefully controlled in source area.	\$372,000
Alternative 2 - Limited Source Removal - Intrinsic Remediation - Optional Stormwater Treatment - Long-Term Monitoring	Similar to Alternative 1 except it provides additional protection against benzene discharge into stormwater ponds through contingency sampling and potential completion of exposure pathways to humans or ecological receptors. If required, a portable sparging tank should be very effective in removing low levels of BTEX prior to discharge to pond.	Readily implementable. Long-term management, ground water controls, and monitoring required for an estimated 13 years. Would also require minor construction at stormwater outfall and operation of a simple sparging tank for approximately 5 years.	\$455,000
Alternative 3 - Expanded Mobile LNAPL Removal and Bioventing - Intrinsic Remediation - Long-Term Monitoring	Most effective in reducing soil contamination and more rapidly reducing source of ground water contamination. May prevent BTEX from impacting POC wells if implemented immediately (1995). Could result in increased generation of secondary waste streams that would require additional treatment and disposal.	Difficult to implement in residential area without disruption and potential secondary risk to residents. Could reduce long-term management, ground water use controls and monitoring by 4-5 years compared to Alternative 1 and 2. Increased drilling and system maintenance will increase site worker exposure to contaminated soils and mobile LNAPL.	\$782,000

SECTION 7

LONG-TERM MONITORING PLAN

7.1 OVERVIEW

As discussed in Section 6, the preferred remedial option for the fuel-hydrocarbon contamination present in ground water at UST Site 870 is Alternative 2. This alternative consists of continued mobile LNAPL recovery and bioventing for mobile- and residual-phase LNAPL contamination, and intrinsic remediation with LTM for contaminated ground water. In addition, this alternative has a provision for treatment of stormwater discharge should BTEX compounds in excess of MCLs be detected in stormwater runoff at the stormwater sewer outfall. In keeping with the requirements of this remedial alternative, a LTM plan must be developed. The purpose of LTM is to assess site conditions over time, confirm the effectiveness of naturally occurring processes at reducing contaminant mass and minimizing contaminant migration, validate/calibrate the Bioplume II model, and evaluate the need for additional remediation.

The LTM plan consists of identifying the locations of two separate ground water monitoring networks and developing a ground water and stormwater discharge point sampling and analysis strategy. The strategy described in this section is designed to monitor plume migration and attenuation over time to verify that intrinsic remediation of dissolved-phase BTEX is occurring at rates sufficient to protect potential receptors.

7.2 MONITORING NETWORKS

Two separate ground water monitoring networks will be used at UST Site 870 as part of the intrinsic remediation remedial alternative LTM plan. The first network will consist of nine LTM wells located upgradient, within, and downgradient of the observed total BTEX plume wells and a contingency sampling point at the Pond 5 outfall of the stormwater sewer located along Cambridge Street. The purpose of the LTM well network is to provide short-term confirmation and verification of intrinsic remediation and to verify the results of the

Bioplume II model. The second network of ground water monitoring points will consist of three POC wells. The purpose of the POC monitoring network is to verify that no BTEX compounds in concentrations exceeding MCLs migrate beyond the area under institutional control. Should BTEX compounds be detected through contingency sampling in the stormwater sewer discharge in excess of Federal MCLs, installation and operation of the stormwater treatment system discussed in Section 6 will be implemented. Should BTEX compounds be detected in POC wells above MCLs, other remedial options will be evaluated.

7.2.1 Long-Term Monitoring Network

Nine ground water monitoring wells placed upgradient, within, and immediately downgradient of the existing BTEX contaminant plume will be used to monitor the effectiveness of intrinsic remediation in reducing total contaminant mass and minimizing contaminant migration. Figure 7.1 shows the proposed locations of these wells. One new and four existing monitoring wells (MW-04, MW-05, EPA-82-D and MW-10) will be used as LTM wells to monitor natural attenuation within the anaerobic treatment zone and BTEX concentrations in the source area. In the event that MW-04 is screened to shallow to permit an accurate ground water sample, monitoring wells EPA-82-I, MW-01, or MW-14 should be considered as a substitute LTM location. One new LTM well should be placed within the aerobic treatment zone to monitor natural attenuation within this zone. Two new LTM wells should be placed downgradient of the BTEX plume. Sampling and analysis of the downgradient LTM well (and the POC wells) will be useful in monitoring changes in ground water chemistry through time and will facilitate early detection of plume migration. Because the velocity of the dissolved-phase BTEX plume is retarded relative to the advective ground water velocity and the velocities of the electron acceptors are not, depleted DO, nitrate, and sulfate concentrations, and elevated ferrous iron and methane concentrations will advance in front of the BTEX plume. Thus, changes in the concentrations of the electron acceptors can be used to provide early warning of BTEX plume encroachment on the LTM and POC wells.

An existing CPT monitoring point (CPT-40) should be used as an upgradient LTM well. CPT-40 was selected as an upgradient LTM point because it has historically been free of ground water contamination and is suited for monitoring background levels of ground water electron acceptors, pH, and oxidation/reduction potential. The different well diameter of CPT-40 compared to the other proposed LTM wells is not a sampling issue because background levels of ground water parameters are presumed to be uniform throughout the

LEGEND

- CPT-26 ▲ CONE PENETROMETER TEST POINT/PIEZOMETER
- MW-11 ● MONITORING WELL LOCATION
- AUGUST 1993 GEOPROBE SAMPLING LOCATION
- STORM DRAIN SURVEY LOCATION
- EPA-82-M ■ JULY 1994 GEOPROBE SAMPLING LOCATION
- EPA-82-KK ◆ JULY 1994 SOIL BORING LOCATION
- EPA-82-R ○ JULY 1994 SOIL GAS LOCATION
- + + + + + RAILROAD TRACKS
- - - HILL AFB BOUNDARY
- (L) PROPOSED LONG-TERM MONITORING WELL
- (C) PROPOSED POINT-OF-COMPLIANCE MONITORING WELL
- (SP) PROPOSED CONTINGENCY SAMPLING POINT
- 373.1 BTEX CONCENTRATION (μg/L)
- 1000 LINE OF EQUAL BTEX CONCENTRATION (μg/L)(JULY 1994)

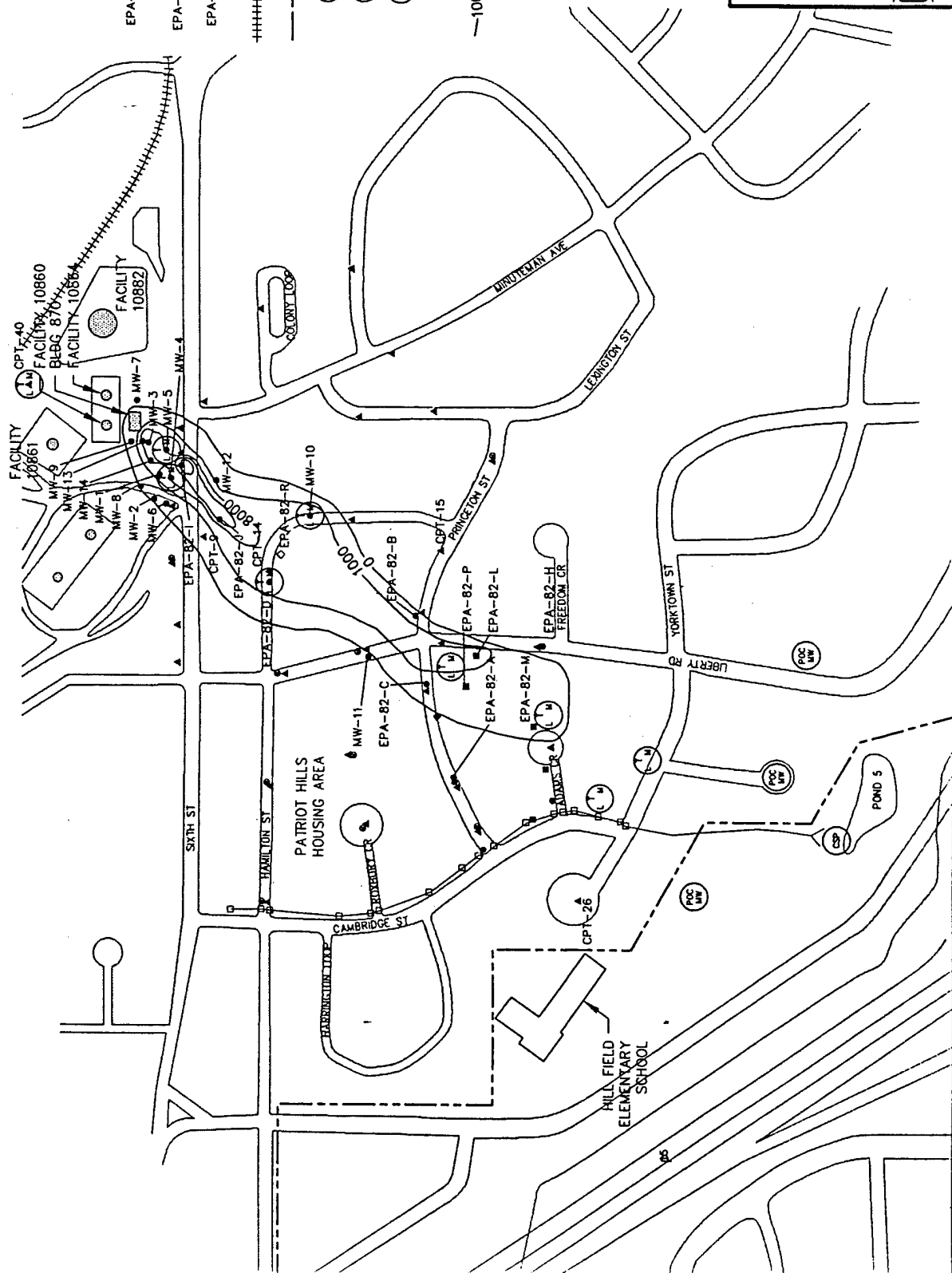
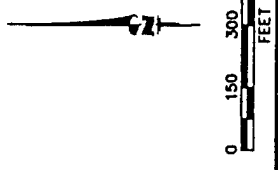

FIGURE 7.1
PROPOSED LONG-TERM MONITORING WELL AND POINT-OF-COMPLIANCE MONITORING WELL PLACEMENT
 UST Site 870
 Intrinsic Remediation EE/CA
 Hill Air Force Base, Utah

PARSONS ENGINEERING SCIENCE, INC.
 Denver, Colorado

the shallow aquifer. In the case that CPT-40 is destroyed or inaccessible, a new LTM well (described in Section 7) will be installed instead.

The LTM network will supplement the POC monitoring network in monitoring plume migration and will allow model predictions to be validated. Such monitoring of the plume will allow additional response time if BTEX concentrations within the plume are increasing or if the plume begins to migrate further than expected. If Federal MCLs are exceeded in the proposed LTM well near the intersection of Cambridge Street and Yorktown Street, additional samples will be taken at the Cambridge Street stormwater outfall which will act as a contingency sampling point (Figure 7.1). New LTM wells should be constructed of 2-inch PVC with 5 to 10 feet of 0.010-inch-slotted screen. The screened interval should be within the same stratigraphic horizon as the contaminant plume. The screened interval should be chosen so that the base of the screen coincides with the interface between the sandy saturated zone and the underlying competent clay to silty clay and the top of the screen is above the seasonal high water table.

7.2.2 Point-of-Compliance Monitoring Network

Three new POC monitoring wells should be installed to verify that no contaminated ground water exceeding MCLs migrates beyond the area under institutional control. Figure 7.1 shows the proposed locations for the POC wells. POC sampling points will be used to demonstrate protection of human health and the environment and compliance with site-specific numerical remediation goals (i.e., MCLs for the BTEX constituents).

As described for the LTM wells, the POC wells also should be screened in the same hydrogeologic unit as the contaminant plume. Data presented in this report concerning the nature and extent of contamination at the site suggest that a 5- to 10-foot screen extending from slightly above the ground water table to the interface between the sandy saturated zone and the underlying competent clay to silty clay confining unit should be used to monitor changes in ground water chemistry at these locations. New POC wells should be constructed of 2-inch PVC and a 0.010-inch slotted screen should be used.

7.3 GROUND WATER SAMPLING AND ANALYSIS

To ensure that sufficient contaminant removal is occurring at UST Site -870 to protect human health and the environment and meet site-specific remediation goals, the LTM plan includes a comprehensive sampling and analysis plan. To supplement the LTM sampling and

analysis plan presented herein, a site-specific ground water sampling and analysis plan should be prepared prior to initiating the LTM program.

7.3.1 Analytical Protocol

7.3.1.1 Long-Term Monitoring Well Analytical Protocol

All LTM wells will be sampled and analyzed to monitor trends in ground water chemistry and to verify the effectiveness of intrinsic remediation at the site. Water level measurements are to be made during each sampling event. All ground water samples from LTM wells will be analyzed according to the analytical protocol presented in Table 7.1. Any water samples collected from the stormwater sewer outfall contingency sampling point should be sampled for aromatic hydrocarbons only. A site-specific ground water sampling and analysis plan should be prepared using this analytical protocol prior to initiating the LTM program.

7.3.1.2 Point-Of-Compliance Monitoring Point Analytical Protocol

All POC sampling points will be sampled and analyzed to monitor trends in ground water chemistry, to verify the effectiveness of intrinsic remediation at the site, and to demonstrate protection of human health and the environment and compliance with site-specific numerical remediation goals. Water level measurements are to be made in POC wells during each sampling event. All ground water samples from POC wells will be analyzed according to the analytical protocol presented in Table 7.2. A site-specific ground water sampling and analysis plan should be prepared using this analytical protocol prior to initiating the LTM program.

7.3.2 Frequency

Each of the LTM and POC sampling points will be sampled twice each year for 13 years. If the data collected during this time period supports the anticipated effectiveness of the intrinsic remediation alternative at this site, the sampling frequency can be reduced to once every year for all wells in the LTM program, or eliminated. The contingent sampling point (located at the Cambridge Street stormwater outfall) will be sampled only if BTEX is detected above MCLs at the LTM well near the intersection of Cambridge Street and Yorktown Street. If the data collected at any time during the monitoring period indicate the need for additional remedial activities at the site (i.e., by exceeding MCLs at POC locations) sampling frequency should be adjusted accordingly.

TABLE 7.1
LONG-TERM MONITORING ANALYTICAL PROTOCOL
UST SITE 870 INTRINSIC REMEDIATION EE/CA
HILL AFB, UTAH

Analyte	Method/Reference	Comments	Data Use	Recommended Frequency of Analysis	Sample Volume, Sample Container, Sample Preservation	Field or Fixed-Base Laboratory
Ferrous (Fe ²⁺)	Colorimetric A3500-Fe D	Field only	Elevated ferrous iron concentrations may be indicative of the anaerobic biodegradation process of iron reduction	Semiannually	Collect 100 mL of water in a glass container, acidify with hydrochloric acid per method	Field
Ferrous (Fe ²⁺)	Colorimetric HACH 25140-25	Alternate method; field only	Elevated ferrous iron concentrations may be indicative of the anaerobic biodegradation process of iron reduction	Semiannually	Collect 100 mL of water in a glass container	Field
Temperature	E170.1	Field only	Metabolism rates for microorganisms depend on temperature	Semiannually	N/A	Field
Dissolved Oxygen	Dissolved oxygen meter	Refer to Method A4500 for a comparable laboratory procedure	The oxygen concentration is a data input to the Bioplume II model; concentrations less than 1 mg/L generally indicate an anaerobic pathway	Semiannually	Collect 300 mL of water in biochemical oxygen demand bottles; analyze immediately; alternately, measure dissolved oxygen in situ	Field
pH	E150.1/SW9040, direct reading meter	Protocols/Handbook methods ^a	Aerobic and anaerobic processes are pH-sensitive	Semiannually	Collect 100-250 mL of water in a glass or plastic container, analyze immediately	Field
Conductivity	E120.1/SW9050, direct reading meter	Protocols/Handbook methods	General water quality parameter used as a marker to verify that site samples are obtained from the same ground water system	Semiannually	Collect 100-250 mL of water in a glass or plastic container	Field
Nitrate (NO ₃ ⁻)	IC method E300 or method SW9056; colorimetric, method E353.2	Method E300 is a Handbook method; method SW9056 is an equivalent procedure	Substrate for microbial respiration if oxygen is depleted	Semiannually	Collect up to 40 mL of water in a glass or plastic container, cool to 4°C; analyze within 48 hours	Fixed-base

TABLE 7.1 (CONCLUDED)

LONG-TERM MONITORING ANALYTICAL PROTOCOL
UST SITE 870 INTRINSIC REMEDIATION EE/CA

HILL AFB, UTAH

Analyte	Method/Reference	Comments	Data Use	Recommended Frequency of Analysis	Sample Volume, Sample Container, Sample Preservation	Field or Fixed-Base Laboratory
Sulfate (SO ₄ ²⁻)	IC method E300 or method SW9056 or HACH SulfaVer 4 method	Method E300 is a Handbook method; method SW9056 is an equivalent procedure. HACH method is Photometric	Substrate for anaerobic microbial respiration	Semiannually	Collect up to 40 mL of water in a glass or plastic container, cool to 4°C	Fixed-base or field (for HACH method)
Redox potential	A2580 B	Measurements are made with electrodes; results are displayed on a meter, samples should be protected from exposure to atmospheric oxygen	The redox potential of ground water influences and is influenced by biologically mediated reactions; the redox potential of ground water may range from more than 200 mV to less than -400 mV	Semiannually	Collect 100-250 mL of water in a glass container, filling container from bottom; analyze immediately	Field
Methane	RKSOP-114 modified to analyze water samples for methane by headspace sampling with dual thermal conductivity and flame ionization detection.	Method published and used by the US Environmental Protection Agency Robert S. Kerr Laboratory	The presence of methane suggests BTEX degradation via an anaerobic pathway utilizing carbon dioxide (carbonate) as the electron acceptor (methanogenesis)	Semiannually	Collect water samples in 40 mL volatile organic analysis (VOA) vials with butyl gray/Teflon-lined caps (zero headspace); cool to 4°C	Fixed-base
Aromatic hydrocarbons (BTEX)	Purge and trap GC method SW8020	Handbook method; analysis may be extended to higher molecular weight alkylbenzenes	BTEX is the primary target analyte for monitoring natural attenuation; BTEX concentrations must also be measured for regulatory compliance	Semiannually	Collect water samples in a 40 mL VOA vial with zero headspace; cool to 4°C; add hydrochloric acid to pH 2	Fixed-base

a/ Protocol methods are presented by Wiedemeier *et al.*, 1994

TABLE 7.2
POINT-OF COMPLIANCE MONITORING ANALYTICAL PROTOCOL
UST SITE 870 INTRINSIC REMEDIATION EE/CA
HILL AFB, UTAH

Analyte	Method/Reference	Comments	Data Use	Recommended Frequency of Analysis	Sample Volume, Sample Container, Sample Preservation	Field or Fixed-Base Laboratory
Temperature	E170.1	Field only	Well development	Semiannually	N/A	Field
Dissolved Oxygen	Dissolved oxygen meter	Refer to method A4500 for a comparable laboratory procedure	The oxygen concentration is a data input to the Bioplume model; concentrations less than 1 mg/L generally indicate an anaerobic pathway	Semiannually	Collect 300 mL of water in biochemical oxygen demand bottles; analyze immediately; alternately, measure dissolved oxygen in situ	Field
pH	E150.1/SW9040, direct reading meter	Protocols/Handbook methods ^a	Aerobic and anaerobic processes are pH-sensitive	Semiannually	Collect 100-250 mL of water in a glass or plastic container; analyze immediately	Field
Conductivity	E120.1/SW9050, direct reading meter	Protocols/Handbook methods	General water quality parameter used as a marker to verify that site samples are obtained from the same ground water system	Semiannually	Collect 100-250 mL of water in a glass or plastic container	Field
Redox potential	A2580 B	Measurements are made with electrodes; results are displayed on a meter; samples should be protected from exposure to atmospheric oxygen	The redox potential of ground water influences and is influenced by biologically mediated reactions; the redox potential of ground water may range from more than 200 mV to less than -400 mV	Semiannually	Collect 100-250 mL of water in a glass container, filling container from bottom; analyze immediately	Field
Aromatic hydrocarbons (BTEX)	Purge and trap GC method SW8020	Handbook method; analysis may be extended to higher molecular weight alkylbenzenes	BTEX is the primary target analyte for monitoring natural attenuation; BTEX concentrations must also be measured for regulatory compliance	Semiannually	Collect water samples in a 40 mL VOA vial with zero headspace; cool to 4°C; add hydrochloric acid to pH 2	Fixed-base

a/ Protocol methods are presented by Wiedemeier *et al.*, 1994

SECTION 8

CONCLUSIONS AND RECOMMENDATIONS

This report presents the results of an EE/CA conducted by Parsons ES in conjunction with researchers from the USEPA RSKERL to determine the potential for intrinsic remediation of, and to develop an appropriate remedial alternative for, BTEX compounds dissolved in the shallow ground water at UST Site 870, Hill AFB, Utah. Previous investigations determined that JP-4 jet fuel had been released into the soil and shallow ground water at the site through POL operations. Chemical analysis of a sample of mobile LNAPL confirms that residual- and mobile-phase LNAPL contamination at the site is probably dominated by weathered JP-4 jet fuel. The main emphasis of the work described herein was to evaluate the potential for naturally occurring degradation mechanisms to reduce dissolved-phase fuel-hydrocarbon concentrations in ground water to levels that are protective of human health and the environment.

To collect the data necessary for the intrinsic remediation demonstration, Parsons ES and USEPA researchers collected soil and ground water samples from the site. Physical and chemical data collected under this program were supplemented with data collected during previous site characterization events. Site-specific geologic, hydrologic, and laboratory analytical data were then used in the Bioplume II numerical ground water model to simulate the effects of advection, dispersion, sorption, and biodegradation on the fate and transport of the dissolved-phase BTEX plume. Extensive site-specific data were used for model implementation. Model parameters that could not be obtained from existing site data were estimated using widely accepted literature values for sediments similar to those found at the site. Conservative aquifer parameters were used to construct the Bioplume II model for this study, and therefore, the model results presented herein represent a worst-case scenario. Actual dissolved-phase BTEX degradation rates observed during LTM at the site will probably be greater than predicted by this study. This will result in faster removal rates for the BTEX compounds and a shorter plume migration distance than predicted by the Bioplume II model.

The Bioplume II model predicts that the BTEX plume will approach the stormwater sewer that runs parallel to Cambridge Street in 1 to 4 years at concentrations of approximately 1 µg/L. After this time, the plume will recede somewhat and reach steady-state equilibrium (continuous source), or will continue to recede until the plume disappears (source reduction). Ground water geochemistry suggests that DO, nitrate, ferric hydroxide, sulfate, and carbon dioxide present in site ground water have the capacity to assimilate at least 31,370 µg/L of total BTEX. The highest plausible total BTEX concentration observed at the site was 26,576 µg/L in August 1992. Based on site observations, ground water at the POL site has enough assimilative capacity to degrade dissolved-phase BTEX that partitions from the LNAPL plume into the ground water before the plume migrates 1,600 feet downgradient from the source area.

The results of the modeling effort and the intrinsic remediation demonstration indicate that dissolved-phase petroleum hydrocarbon contamination present in ground water poses no significant risk to human health or the environment in its present known, or predicted future, concentration and distribution. It is therefore recommended that intrinsic remediation with LTM be implemented for dissolved-phase BTEX contamination found in ground water at this site. To reduce sources of continuing contamination, it is also recommended that mobile LNAPL recovery operations and bioventing activities currently operating at the site be continued.

To verify the predictions made during the Bioplume II modeling effort and to monitor the long-term migration and degradation of the contaminant plume, it is recommended that nine LTM wells, three POC monitoring wells, and a contingent sampling point be used at the mouth of the stormwater sewer that runs along Cambridge Street and empties into Pond 5. Regular sampling and analysis of ground water from the LTM and POC wells will allow sufficient time to implement hydraulic controls to contain the plume if BTEX compounds are detected in the POC wells. These wells should be sampled on a semiannual basis for 13 years. If Federal MCLs are exceeded at the LTM well near the Cambridge Street and Yorktown Street intersection, the contingency sampling point located at the stormwater outfall near Pond 5 must be sampled. If site conditions indicate that the contaminant plume is receding or gone at this time or sooner, sampling can be discontinued. Ground water samples should be analyzed for the analytes described in Section 7 of this report. If BTEX concentrations in ground water in the contingency sampling point or POC wells are found to exceed MCLs, additional corrective actions should be implemented to remediate ground water at the site, as described in this report.

SECTION 9

REFERENCES

- Abdul, S.A., Gibson, T.L., and Rai, D.N., 1987, Statistical Correlations for Predicting the Partition Coefficient for Nonpolar Organic Contaminants Between Aquifer Organic Carbon and Water. *Hazardous Waste and Hazardous Materials*, 4(3):211-222.
- Abdul, A.S., Kia, S.F., and Gibson, T.L., 1989, Limitations of monitoring wells for the detection and quantification of petroleum products in soils and aquifers: *Ground Water Monitoring Review*, Spring, 1989, p. 90-99.
- Anderson, M.P., and Woessner, W.W., 1992, Applied Groundwater Modeling - Simulation of Flow and Advective Transport: *Academic Press*, New York, 381 p.
- Ballesteros, T.P., Fiedler, F.R., and Kinner, N.E., 1994, An investigation of the relationship between actual and apparent gasoline thickness in a uniform sand aquifer: *Ground Water*, v. 32, no. 5, p. 708-718.
- Barr, K.D., 1993, Enhanced groundwater remediation by bioventing and its simulation by modeling, In Proceedings of the 1993 *Environmental Restoration Technology Transfer Symposium*, January 26-28, Wyndham Hotel, San Antonio, Texas: United States Air Force Center for Environmental Excellence.
- Beller, H.R., Reinhard, M., and Grbic-Galic, D., 1992, Metabolic byproducts of anaerobic toluene degradation by sulfate-reducing enrichment cultures: *Applied Environmental Microbiology*, v. 58, p. 3192-3195.
- Blake, S.B., and Hall, R.A., 1984, Monitoring petroleum spills with wells - some problems and solutions: In *Proceedings of the Fourth National Symposium on Aquifer Restoration and Ground Water Monitoring*: May 23-25, 1984, p. 305-310.
- Bohon, R.L., and Claussen, W.F., 1951, The Solubility of Aromatic Hydrocarbons in Water. *Journal of American Chemical Society*, 73(4):1571-1578.
- Borden, R.C. and P.B. Bedient. 1986. Transport of Dissolved Hydrocarbons Influenced by Oxygen Limited Biodegradation - Theoretical Development. *Water Resources Research*, 22 (13) 1973-1982.
- Bouwer, H., and Rice, R.C., 1976, A Slug Test for Determining Hydraulic Conductivity of Unconfined Aquifers With Completely or Partially Penetrating Wells: *Water Resources Research*, v. 12, no. 3, p. 423-428.

- Bouwer, H., 1989, The Bouwer and Rice slug test - an update: *Ground Water*, v. 27, no. 3, p. 304-309.
- Bouwer, E.J., 1992, Bioremediation of Subsurface Contaminants, In R. Mitchell, editor, *Environmental Microbiology*, Wiley-Liss, New York, New York.
- Concawe, 1979, Protection of groundwater from oil pollution; *Den Haag*, Report No. 3/79.
- Cozzarelli, I.M., Eganhouse, R.P., and Baedecker, M.J., 1990, Transformation of Monoaromatic Hydrocarbons to Organic Acids in Anoxic Ground Water Environment. *Environmental and Geological Water Science*, 16.
- Davies, J.S., and Westlake, D.W.S., 1979, Crude Oil Utilization by Fungi. *Canadian Journal of Microbiology*, 25:146-156.
- de Pastrovich, T.L., Baradat, Y., Barthel, R., Chiarelli, A., and Fussell, D.R., 1979, Protection of groundwater from oil pollution: *CONCAWE*, The Hague, 61 p.
- Domenico, P.A., and Schwartz, F.W., 1990, Physical and Chemical Hydrogeology: *John Wiley and Sons*, New York, 824 p.
- Edwards, E.A., and Grbic-Galic, D., 1992, Complete mineralization of benzene by aquifer microorganisms under strictly anaerobic conditions: *Applied Environmental Microbiology*, v. 58, p. 2663-2666.
- Edwards, E.A., Wells, L.E., Reinhard, M., and Grbic-Galic, D., 1992, Anaerobic degradation of toluene and xylene by aquifer microorganisms under sulfate-reducing conditions: *Applied Environmental Microbiology*, v. 58, p. 794-800.
- Feth, J.H., Barker, D.A., Moore, L.G., and Brown, R.J., and Veirs, C.E., 1966, Lake Bonneville - Geology and Hydrogeology of the Weber Delta District, Including Ogden, Utah: *US Geological Survey Professional Paper* 518, 76 p.
- Freeze, R.A., and Cherry, J.A., 1979, *Ground Water*. Prentice-Hall, Inc., Englewood Cliffs, New Jersey.
- Gemperline, Andrew, 1995, OO-ALC/EMR, personal written communication, Hill Air Force Base, 7276 Wardleigh Road, Utah, 84056-5127.
- Geoprobe Systems[®], 1994, Geoprobe GH-40 Soil Probing Hammer Operating Instructions, Technical Bulletin No. 94-040A.
- Goldstein, R.M., Mallory, L.M., and Alexander, M., 1985, Reasons for Possible Failure of Inoculation to Enhance Biodegradation. *Applied Environmental Microbiology*, 50(4):977-983.
- Grbic'-Galic', D., and Vogel, T.M., 1987, Transformation of toluene and benzene by mixed methanogenic cultures: *Applied and Environmental Microbiology*, v. 53, p. 254-260.
- Grbic'-Galic', D., 1990, Anaerobic microbial transformation of nonoxygenated aromatic and alicyclic compounds in soil, subsurface, and freshwater sediments: In J.M. Bollag and G. Stotzky, editors, *Soil Biochemistry*: Marcel Dekker, Inc., New York, p. 117-189.

- Hall, R.A., Blake, S.B., and Champlin, S.C. Jr., 1984, Determination of hydrocarbon thicknesses in sediments using borehole data: In *Proceedings of the Fourth National Symposium on Aquifer Restoration and Ground Water Monitoring*: May 23-25, 1984, p. 300-304.
- Hampton, D.R., and Miller, P.D.G., 1988, Laboratory investigation of the relationship between actual and apparent product thickness in sands:
- Hinchee, R.E., Alleman, B.C., Miller, R.N., and Vogel, C., 1993, Bioventing, In *Proceedings of the 1993 Environmental Restoration Technology Transfer Symposium*, January 26-28, Wyndham Hotel, San Antonio, Texas: United States Air Force Center for Environmental Excellence.
- Hine, J., and Mookerjee, P.K., 1975, The Intrinsic Hydrophilic Character of Organic Compounds. Correlations in Terms of Structural Contributions. *Journal of Organic Chemistry*, 40(3):292-298.
- Hopper, D.J., 1978, Microbial Degradation of Aromatic Hydrocarbons In R.J. Watkinson (editor), *Developments in Biodegradation of Hydrocarbons, I. Applied Science Publishers, Ltd., London*.
- Hughes, J.P., Sullivan, C.R., and Zinner, R.E., 1988, Two techniques for determining the true hydrocarbon thickness in an unconfined sandy aquifer: *In Proceedings of the Petroleum Hydrocarbons and Organic Chemicals in Ground Water: Prevention, Detection, and Restoration Conference: NWWA/API*, p. 291 -314.
- Hutchins, S.R., 1991, Biodegradation of monoaromatic hydrocarbons by aquifer microorganisms using oxygen, nitrate, or nitrous oxide as the terminal electron acceptor: *Applied Environmental Microbiology*, v. 57, p. 2403-2407.
- Isnard, S., and Lambert, S., 1988, Estimating Bioconcentration Factors from Octanol-Water Partition Coefficient and Aqueous Solubility. *Chemosphere*, 17(1):21-34.
- James M. Montgomery Consulting Engineers, Inc., 1991, *External Draft Site Characterization Report for UST Site 870.0 (AGSS)*, December, 1991.
- James M. Montgomery Consulting Engineers, Inc., 1992a, *Free Product Recovery Letter Report, UST Site 870.0 (EGSS)*, November, 1992.
- James M. Montgomery Consulting Engineers, Inc., 1992b, *Pumping Tests and Product Thickness Test Letter Report, UST Site 870.0 (EGSS)*, November, 1992.
- James M. Montgomery Consulting Engineers, Inc., 1993a, *Remedial Options Letter Report*, January, 1993.
- James M. Montgomery Consulting Engineers, Inc., 1993b, *Draft Investigation Summary Report, UST Site 870*, February, 1993.
- Jamison, V.W., Raymond, R.L., and Hudson, J.O. Jr., 1975, Biodegradation of high-octane gasoline in ground water: *Developments in Industrial Microbiology*, v. 16.

- Jones, J.G., and Eddington, M.A., 1968, An Ecological Survey of Hydrocarbon-Oxidizing Microorganisms. *Journal of General Microbiology*, 52:381-390.
- Jury, W.A., Spencer, W.F., and Farmer, W.J., 1984, Behavior Assessment Model for Trace Organics in Soil: III, Application of Screening Model. *Journal of Environmental Quality*, 13(4):573-579.
- Kemblowski, M.W., and Chiang, C.Y., 1990, Hydrocarbon thickness fluctuations in monitoring wells: *Ground Water* v. 28, no. 2, p. 244-252.
- Konikow, L.F., and Bredehoeft, J.D., 1978, Computer model of two-dimensional solute transport and dispersion in ground water: *United States Geological Survey, Techniques of Water Resources Investigations of the United States Geological Survey*, Book 7, Chapter C2, 90 p.
- Lenhard, R.J., and Parker, J.C., 1990, Estimation of free hydrocarbon volume from fluid levels in monitoring wells: *Ground Water*, v. 28, no. 1, p. 57-67.
- Lovely, D.R., Baedecker, M.J., Lonergan, D.J., Cozzarelli, I.M., Phillips, E.J.P., and Siegel, D.I., 1989, Oxidation of aromatic contaminants coupled to microbial iron reduction: *Nature*, v. 339, p. 297-299.
- Lyman, W.J., Reidy, P.J., and Levy, B., 1992, *Mobility and Degradation of Organic Contaminants in Subsurface Environments*. C.K. Smoley, Inc., Chelsea, Michigan.
- Mackay, D., and Wolkoff, A.W., 1973, Rate of Evaporation of Low-Solubility Contaminants from Water Bodies to Atmosphere. *Environmental Science and Technology*, 7(7):611-614.
- Mackay, D., and Shiu, W.Y., 1981, A Critical Review of Henry's Law Constants for Chemicals of Environmental Interest. *Journal of Physical Chemistry Reference Data*, 10(4):1175-1199.
- Martel, 1987, Military Jet Fuels 1944-1987: AF Wright Aeronautical Laboratories, Wright-Patterson Air Force Base, Ohio.
- Mercer, J.W., and Cohen, R.M., 1990, A review of immiscible fluids in the subsurface - properties, models, characterization and remediation: *Journal of Contaminant Hydrology*, v.6, p. 107-163.
- Miller, R.N., Downey, D.C., Carmen, V.A., Hinchee, R.E., and Leeson, A., 1993, A summary of bioventing performance at multiple sites, In Proceedings of the Petroleum Hydrocarbons and Organic Chemicals in Ground Water: *Prevention, Detection, and Restoration Conference*: NWWA/API, p. 397 - 411.
- Miller, M.M., Wasik, S.P., Huang, G.L., Shiu, W.Y., and Mackay, D., 1985, Relationships Between Octanol-Water Partition Coefficient and Aqueous Solubility. *Environmental Science and Technology*, 19(6):522-529.
- Montgomery Watson, Inc., 1994a, Site Monitoring and Product Recovery Progress Letter Report.

- Montgomery Watson, Inc., 1994b, December 1993/January 1994 Quarterly Ground-Water sampling letter.
- Pankow, J.F., and Rosen, M.E., 1988, Determination of Volatile Compounds in Water by Purging Directly to a Capillary Column with Whole Column Cryotrapping. *Environmental Science and Technology*, 22(4):398-405.
- Perry, J.J., 1984, Microbial Metabolism of Cyclic Alkanes In R.M. Atlas (editor), *Petroleum Microbiology*. Macmillan Publishing Co., New York, New York.
- Ribbons, D.W., and Eaton, R.W., 1992, Chemical Transformations of Aromatic Hydrocarbons that Support the Growth of Microorganisms In Ralph Mitchell (editor), *Environmental Microbiology*. Wiley-Liss, New York, New York.
- Rifai, H.S., Bedient, P.B., Wilson, J.T., Miller, K.M., and Armstrong, J.M., 1988, Biodegradation modeling at aviation fuel spill site: *Journal of Environmental Engineering*, v. 114, no. 5, p. 1007-1029.
- Rifai, H.S., 1995, Proceedings of the 3rd Annual Batelle Conference, San Diego, CA, April, 1995. (*To be published*)
- Smith, J.H., Harper, J.C., and Jaber, H., 1981, Analysis and environmental fate of Air Force distillate and high density fuels: *Engineering & Services Laboratory*, Tyndall Air Force Base, Florida
- Testa, S.M., and Paczkowski, M.T., 1989, Volume determination and recoverability of free hydrocarbon: *Ground Water Monitoring Review*, Winter, 1989, p. 120-128.
- US Environmental Protection Agency, 1991, Role of the Baseline Risk Assessment in Superfund Remedy Selection Decisions. Memorandum from Don R. Clay, Assistant Administrator of the Office of Solid Waste and Emergency Response, OSWER Directive 9355.0-30.
- Valsaraj, K.T., 1988, On the Physio-Chemical Aspects of Partitioning of Non-Polar Hydrophobic Organics at the Air-Water Interface. *Chemosphere*, 17(5):875-887.
- Verschueren, K., 1983, *Handbook of Environmental Data on Organic Chemicals*. Van Nostrand Reinhold Co., New York, New York.
- von Gunten, U., and Zobrist, J., 1993, Biogeochemical changes in groundwater-infiltration systems - Column Studies: *Geochem. Cosmochim Acta*, v.57, p. 3895-3906.
- Walton, W.C., 1988, Practical Aspects of Ground Water Modeling: *National Water Well Association*, Dublin, Ohio, 587 p.
- Wilson, B.H., Smith, G.B., and Rees, J.F., 1986, Biotransformations of Selected Alkylbenzenes and Halogenated Aliphatic Hydrocarbons in Methanogenic Aquifer Material: A Microcosm Study. *Environmental Science and Technology*, 20(10):997-1002.

- Wilson, B.H., Wilson, J.T., Kampbell, D.H., Bledsoe, B.E., and Armstrong, J.M., 1990, Biotransformation of Monoaromatic and Chlorinated Hydrocarbons at an Aviation Gasoline Spill Site. *Geomicrobiology Journal*, 8:225-240.
- Wilson, J.T., 1994, Personal Communication, RE: nitrate-BTEX reactions in ground water, USEPA RSKERL.
- Wiedemeier, T.H., Downey, D.C., Wilson, J.T., Kampbell, D.H., Miller, R.N., and Hansen, J.E., 1994, *Draft Technical Protocol for Implimenting the Intrinsic Remediation with Long-Term Monitoring Option for Natural Attenuation of Dissolved-Phase Fuel Contamination in Ground Water*: Air Force Center for Environmental Excellence, Brooks Air Force Base, Texas.

APPENDIX F

INTRINSIC REMEDIATION DEMONSTRATION AT PATRICK AFB, FLORIDA

**FINAL
INTRINSIC REMEDIATION
TREATIBILITY STUDY**

for

**SITE ST-29
PATRICK AIR FORCE BASE
FLORIDA**

August 1995

Prepared for:

**AIR FORCE CENTER FOR ENVIRONMENTAL EXCELLENCE
BROOKS AIR FORCE BASE
SAN ANTONIO, TEXAS**

AND

**PATRICK AIR FORCE BASE
FLORIDA**

Prepared by:

**Parsons Engineering Science, Inc.
1700 Broadway, Suite 900
Denver, Colorado 80290**

EXECUTIVE SUMMARY

This report presents the results of a treatability study (TS) performed by Parsons Engineering Science, Inc. (Parsons ES) at Patrick Air Force Base, Florida to evaluate the use of intrinsic remediation with long-term monitoring (LTM) as a remedial option for dissolved benzene, toluene, ethylbenzene, and xylene (BTEX) contamination in the shallow saturated zone near the BX Service Station (Site ST-29). Soil and groundwater contamination caused by motor vehicle gasoline is known to occur at the site, with contamination being present in the aqueous and gaseous phases and as residual light nonaqueous-phase liquid (LNAPL) within the aquifer matrix. There is no evidence of mobile LNAPL (free product) at this site. This study focused on the impact of the dissolved BTEX and residual LNAPL on the shallow groundwater system at the site. Site history and the results of previous soil and groundwater investigations also are summarized in this report. To ensure compliance with Chapter 62-770.600(8) of the Florida Administrative Code (FAC), future groundwater sampling at the site should include an analysis of all compounds specific to underground storage tank releases identified under this code (as listed in Table 6.1).

An important component of this study was an assessment of the potential for contamination in groundwater to migrate from Site ST-29 to potential exposure points. The Bioplume II solute fate and transport model was used to estimate the rate and direction of dissolved BTEX movement through the shallow saturated zone under the influence of advection, dispersion, sorption, and biodegradation. Input parameters for the Bioplume II model were obtained from existing site characterization data, supplemented with data collected by Parsons ES in conjunction with personnel from the United States Environmental Protection Agency (USEPA) Robert S. Kerr Environmental Research Laboratory. Model parameters that were not measured at the site were estimated using reasonable literature values for materials similar to those found at the site.

The results of this study suggest that dissolved BTEX contamination present in groundwater poses no significant threat to human health or the environment at its present, or predicted future, concentration and distribution under current land use conditions. The Air Force therefore proposes to implement intrinsic remediation with LTM for dissolved BTEX contamination in groundwater at this site. To reduce sources of continuing contamination, the Air Force also proposes to continue bioventing activities currently taking place at the site.

To verify the Bioplume II model predictions, the Air Force proposes to use six LTM wells/points and three point-of-compliance (POC) monitoring wells to monitor the long-term migration and degradation of the dissolved BTEX plume. Regular sampling and analysis of groundwater from these sampling points will allow the effectiveness of intrinsic remediation to be monitored and should allow sufficient time to implement hydraulic controls to contain the plume if BTEX compounds are detected at levels of regulatory concern in the POC wells. These wells should be sampled on a semiannual basis for at least 10 years. If the data collected during this period support the anticipated effectiveness of intrinsic remediation, the sampling frequency can be reduced to once every year for 5 years. If chemical concentrations in groundwater from the POC wells exceed the Florida regulatory standards [per 62-770.600(8), FAC] of 1 microgram per liter ($\mu\text{g/L}$) for benzene, 50 $\mu\text{g/L}$ for total BTEX, 3 $\mu\text{g/L}$ for 1,2-dichloroethane, 0.02 $\mu\text{g/L}$ for 1,2-dibromoethane, 50 $\mu\text{g/L}$ for lead, and 50 $\mu\text{g/L}$ for methyl tert-butyl ether, additional evaluation or corrective action may be necessary to remediate groundwater at the site.

TABLE OF CONTENTS

EXECUTIVE SUMMARY	ES-1
INTRODUCTION	1-1
1.1 SCOPE AND OBJECTIVES	1-2
1.2 FACILITY BACKGROUND	1-4
1.2.1 Operational and Site Investigation History	1-7
1.2.2 Current Remedial Activities	1-8
SITE CHARACTERIZATION ACTIVITIES	2-1
2.1 CONE PENETROMETRY, MONITORING POINT INSTALLATION, AND SOIL SAMPLING ACTIVITIES	2-2
2.1.1 CPT and Groundwater Monitoring Point Locations	2-4
2.1.2 Groundwater Monitoring Point Installation Procedures	2-4
2.1.3 Soil Sampling	2-12
2.2 GROUNDWATER SAMPLING	2-13
2.2.1 Groundwater Sampling Locations	2-14
2.2.2 Preparation for Sampling	2-14
2.2.3 Sampling Procedures	2-15
2.2.4 Onsite Chemical Parameter Measurement	2-17
2.2.5 Sample Handling	2-18
2.3 AQUIFER TESTING	2-19
2.3.1 Slug Testing	2-19
2.3.2 Slug Test Data Analysis	2-19
PHYSICAL CHARACTERISTICS OF THE STUDY AREA	3-1
3.1 SURFACE FEATURES	3-1
3.1.1 Topography and Surface Water Hydrology	3-1
3.2 REGIONAL GEOLOGY AND HYDROGEOLOGY	3-2
3.3 SITE GEOLOGY AND HYDROGEOLOGY	3-4
3.3.1 Lithology and Stratigraphic Relationships	3-4
3.3.2 Groundwater Hydraulics	3-5
3.3.4 Groundwater Use	3-14
3.4 CLIMATOLOGICAL CHARACTERISTICS	3-14
NATURE AND EXTENT OF CONTAMINATION AND SOIL AND GROUNDWATER GEOCHEMISTRY	4-1
4.1 SOURCE OF CONTAMINATION	4-1
4.2 SOIL CHEMISTRY	4-1
4.2.1 Residual Contamination	4-1
4.2.2 Total Organic Carbon	4-5
4.3 GROUNDWATER CHEMISTRY	4-7

4.3.1	Dissolved Contamination.....	4-7
4.3.2	Documented Loss of Contaminants at the Field Scale.....	4-7
4.3.3	Groundwater Geochemistry.....	4-17
4.3.3	Expressed Assimilative Capacity.....	4-35
4.4	DIRECT MICROBIOLOGICAL EVIDENCE OF BTEX BIODEGRADATION	4-36
GROUNDWATER MODEL		5-1
5.1	GENERAL OVERVIEW AND MODEL DESCRIPTION	5-1
5.2	CONCEPTUAL MODEL DESIGN AND ASSUMPTIONS.....	5-2
5.3	INITIAL MODEL SETUP	5-3
5.3.1	Grid Design and Boundary Conditions.....	5-3
5.3.2	Groundwater Elevation and Gradient.....	5-6
5.3.3	BTEX Concentrations.....	5-7
5.3.4	Dissolved Oxygen	5-7
5.4	MODEL CALIBRATION	5-7
5.4.1	Water Table Calibration	5-8
5.4.2	BTEX Plume Calibration.....	5-12
5.5	SENSITIVITY ANALYSIS	5-18
5.6	MODEL RESULTS	5-25
5.6.1	No Source Removal (Model PATC).....	5-25
5.6.2	Source Removal via Bioventing (Model PATD).....	5-28
5.7	CONCLUSIONS AND DISCUSSION.....	5-30
COMPARATIVE ANALYSIS OF REMEDIAL ALTERNATIVES.....		6-1
6.1	REMEDIAL ALTERNATIVE EVALUATION CRITERIA.....	6-1
6.1.1	Long-Term Effectiveness and Permanence	6-2
6.1.2	Implementability.....	6-2
6.1.3	Cost.....	6-2
6.2	FACTORS INFLUENCING ALTERNATIVES DEVELOPMENT.....	6-3
6.2.1	Program Objectives.....	6-3
6.2.2	Contaminant Properties.....	6-4
6.2.3	Site-Specific Conditions	6-5
6.2.4	Summary of Remedial Technology Screening.....	6-11
6.3	BRIEF DESCRIPTION OF REMEDIAL ALTERNATIVES	6-11
6.3.1	Alternative 1 - Bioventing in Source Area, Intrinsic Remediation, and Institutional Controls with Long-Term Monitoring	6-11
6.3.2	Alternative 2 - Intrinsic Remediation and Institutional Controls with Long-Term Groundwater Monitoring.....	6-17
6.4	EVALUATION OF ALTERNATIVES	6-18
6.4.1	Alternative 1 - Continued Bioventing in Source Area, Intrinsic Remediation, and Institutional Controls with Long-Term Monitoring	6-18
6.4.2	Alternative 2 - Intrinsic Remediation and Institutional Controls with Long-Term Groundwater Monitoring	6-20

6.5 RECOMMENDED REMEDIAL APPROACH.....	6-23
LONG-TERM MONITORING PLAN	7-1
7.1 OVERVIEW	7-1
7.2 MONITORING NETWORKS.....	7-2
7.2.1 Long-Term Monitoring Wells.....	7-2
7.2.2 Point-of-Compliance Wells.....	7-7
7.3 GROUNDWATER SAMPLING	7-7
7.3.1 Analytical Protocol.....	7-9
7.3.2 Sampling Frequency	7-9
CONCLUSIONS AND RECOMMENDATIONS	8-1
REFERENCES	9-1

APPENDICES

APPENDIX A	CPT Logs, Monitoring Point Completion Diagrams, and Slug Test Results
APPENDIX B	Soil and Groundwater Analytical Results
APPENDIX C	Model Input and Related Calculations
APPENDIX D	Model Results

TABLES

No.	Title	Page
2.1	CPT Activity Summary.....	2-7
3.1	Water Level Elevation Data.....	3-9
3.2	Slug Test Results.....	3-12
4.1	Fuel Hydrocarbon Compounds Detected in Soil.....	4-3
4.2	Soil Total Organic Carbon Results.....	4-6
4.3	Fuel Hydrocarbon Compounds Detected in Groundwater, March 1994.....	4-8
4.4	Fuel Hydrocarbon Compounds Detected in Groundwater, March/May 1995.....	4-10
4.5	Groundwater Geochemical Data, March 1994	4-19
4.6	Groundwater Geochemical Data, March 1995	4-21
4.7	Expressed Assimilative Capacity of Site Groundwater	4-36

4.8	Volatile Fatty Acids in Groundwater.....	4-37
5.1	Bioplume II Model Input Parameters.....	5-9
5.2	Calculation of Retardation Coefficients.....	5-17
6.1	Point-of-Compliance Remediation Goals	6-10
6.2	Initial Technical Implementability Screening of Technologies and Process Options for Groundwater Remediation	6-12
6.3	Alternative 1 - Cost Estimate.....	6-21
6.4	Alternative 2 - Cost Estimate.....	6-22
6.5	Summary of Remedial Alternatives Evaluation.....	6-24
7.1	Long-Term Monitoring Analytical Protocol.....	7-3
7.2	Point-of-Compliance Monitoring Analytical Protocol.....	7-5

FIGURES

No.	Title	Page
1.1	Site Location.....	1-5
1.2	Site ST-29 Layout.....	1-6
2.1	Schematic of Laser-Induced Fluorescence Cone Penetrometer Probe.....	2-5
2.2	Site ST-29 Sampling Locations	2-6
3.1	Generalized Stratigraphic Sequence.....	3-3
3.2	Location of Hydrogeologic Sections.....	3-6
3.3	Hydrogeologic Cross-Section A-A'	3-7
3.4	Hydrogeologic Cross-Section B-B'	3-8
3.5	Groundwater Elevation Map	3-10
4.1	Soil Hydrocarbon Contamination.....	4-4
4.2	Total BTEX Isopleth Map for Groundwater, March 1994	4-11
4.3	Vertical Profile of Total BTEX Isopleths for Groundwater, March 1994	4-12
4.4	Total BTEX Isopleth Map for Groundwater, March/May 1995	4-13
4.5A	Plot of Total BTEX versus Time for Sampling Locations with Decreasing BTEX Concentrations.....	4-15
4.5B	Plot of Total BTEX versus Time for Sampling Locations with Increasing BTEX Concentrations.....	4-16
4.6	Dissolved Oxygen Isopleth Map for Groundwater	4-22
4.7	Vertical Profile of Dissolved Oxygen Isopleths for Groundwater	4-23
4.8	Nitrate + Nitrite (as Nitrogen) Isopleth Map for Groundwater.....	4-26

4.9	Ferrous Iron Isopleth Map for Groundwater	4-27
4.10	Methane Isopleth Map for Groundwater	4-30
4.11	Vertical Profile of Methane Isopleths for Groundwater	4-31
4.12	Redox Potential Map for Groundwater	4-34
5.1	Model Grid	5-4
5.2	Calibrated Water Table Map.....	5-11
5.3	Location of Simulated Injection Wells	5-13
5.4	Calibrated BTEX Plume.....	5-15
5.5	Model Sensitivity to Variations in Transmissivity.....	5-20
5.6	Model Sensitivity to Variations in Dispersivity.....	5-21
5.7	Model Sensitivity to Variations in the Reaeration Coefficient.....	5-22
5.8	Model Sensitivity to Variations in the Coefficient of Retardation	5-23
5.9	Simulated BTEX Plume After 50 Years (No Source Removal).....	5-26
5.10	Simulated BTEX Plume After 2 Years (With Source Reduction).....	5-31
5.11	Simulated BTEX Plume After 3 Years (With Source Reduction).....	5-32
5.12	Simulated BTEX Plume After 5 Years (With Source Reduction).....	5-33
7.1	Proposed Locations of Long-Term Monitoring and Point-of-Compliance Wells.....	7-6
7.2	Proposed Monitoring Well Completion Diagram	7-8

SECTION 1

INTRODUCTION

This report was prepared by Parsons Engineering Science, Inc. (Parsons ES) and presents the results of a treatability study (TS) conducted for the Air Force Center for Environmental Excellence (AFCEE) to evaluate the use of intrinsic remediation with long-term monitoring (LTM) for remediation of fuel-hydrocarbon-contaminated groundwater at the Base Exchange (BX) Service Station (Site ST-29), Patrick Air Force Base (AFB), Florida. Previous investigations determined that motor vehicle gasoline (MOGAS) had been released into the soil and shallow groundwater at the site. The main emphasis of the work described herein was to evaluate the potential for naturally occurring degradation mechanisms to reduce dissolved benzene, toluene, ethylbenzene, and xylene (BTEX) concentrations in groundwater to levels that are protective of human health and the environment. This demonstration is not intended to be a contamination assessment report or a remedial action plan; rather, it is provided for the use of the Base and its prime environmental contractors as information to be used for future decision making regarding this site.

As used throughout this report, the term "intrinsic remediation" refers to a management strategy that relies on natural attenuation mechanisms to control exposure of potential receptors to concentrations of BTEX in the subsurface that exceed regulatory levels of concern. "Natural attenuation" refers to the actual processes (e.g., sorption, dispersion, and biodegradation) that facilitate intrinsic remediation.

Intrinsic remediation is an innovative remedial approach that relies on natural attenuation to remediate contaminants dissolved in groundwater. Mechanisms of natural attenuation of BTEX dissolved in groundwater include advection, dispersion, dilution from recharge, sorption, volatilization, and biodegradation. Of these processes, biodegradation is the only mechanism working to transform contaminants into innocuous byproducts. Intrinsic bioremediation occurs when indigenous microorganisms work to bring about a reduction in the total mass of contamination in the subsurface without the addition of nutrients. Patterns

and rates of intrinsic remediation can vary markedly from site to site depending on governing physical and chemical processes.

Three lines of evidence can be used to document and quantify the occurrence of intrinsic remediation (National Research Council, 1993; Wiedemeier *et al.*, 1995): 1) documented loss of contaminant mass at the field scale; 2) geochemical evidence; and 3) microbial evidence. All three lines of evidence are used herein to demonstrate the occurrence of intrinsic remediation at Site ST-29, as described in Section 4.

1.1 SCOPE AND OBJECTIVES

Parsons ES, in conjunction with researchers from the United States Environmental Protection Agency (USEPA) Robert S. Kerr Environmental Research Laboratory (RSKERL), was retained by the AFCEE to conduct site characterization and groundwater modeling in support of intrinsic remediation (natural attenuation) with long-term monitoring as part of a nation-wide, multi-site demonstration program.

The intent of the intrinsic remediation demonstration program sponsored by AFCEE is to develop a systematic process for scientifically investigating and documenting naturally occurring subsurface attenuation processes that can be factored into overall site remediation plans. The objective of the program and this specific demonstration is to provide solid evidence of intrinsic remediation of dissolved fuel hydrocarbons in groundwater so that this information can be used by the Base and its prime environmental contractor(s) to develop an effective groundwater remediation strategy. As a result, these demonstrations are not necessarily intended to fulfill specific federal or state requirements regarding site assessments, remedial action plans (RAPs), or other such mandated investigations and reports. A secondary goal of this multi-site initiative is to provide a database from multiple sites that demonstrates that natural processes of contaminant degradation often can reduce contaminant concentrations in groundwater to below acceptable cleanup standards before potential receptor exposure pathways are completed.

The scope of work for this project involved the following tasks:

- Reviewing existing hydrogeologic and soil and groundwater quality data for the site;
- Conducting supplemental site characterization activities to determine the nature and extent of soil and groundwater contamination and to collect geochemical data in support of intrinsic remediation;

- Developing a conceptual hydrogeologic model of the shallow saturated zone, including the current distribution of contaminants and probable contaminant pathways;
- Determining if natural processes of contaminant destruction are occurring in groundwater at the site;
- Performing contaminant fate and transport modeling based on site hydrogeologic conditions using the Bioplume II model;
- Evaluating a range of model input parameters to determine the sensitivity of the model to those parameters and to consider several contaminant fate and transport scenarios;
- Determining if naturally occurring processes are sufficient to minimize BTEX plume expansion so that groundwater quality standards can be met at a downgradient point of compliance (POC);
- Conducting a preliminary exposure assessment for fuel hydrocarbon contamination in groundwater;
- Developing remedial action objectives (RAOs) and reviewing available remedial technologies;
- Using the results of modeling to recommend the most appropriate remedial option based on specific effectiveness, implementability, and cost criteria; and
- Providing an LTM plan that includes LTM and POC well locations and a sampling and analysis plan (SAP).

Site characterization activities in support of intrinsic remediation included grab sampling of groundwater at cone penetrometer testing (CPT) locations, soil sample collection and analysis, groundwater monitoring point installation using the cone penetrometer, and sampling and analysis of groundwater from newly installed and existing monitoring wells and points.

Site-specific data were used to develop a fate and transport model for the site using Bioplume II and to conduct a preliminary exposure pathways analysis. The Bioplume II model was used to simulate the movement and degradation of BTEX in the shallow saturated zone under the influence of advection, dispersion, sorption, and biodegradation. As part of the TS, this modeling effort had three primary objectives: 1) to predict the future extent and concentration of a dissolved contaminant plume by modeling the combined effects of advection, dispersion, sorption, and biodegradation; 2) to assess the possible risk to potential downgradient receptors by conducting a preliminary exposure pathways analysis; and 3) to provide technical support for the intrinsic remediation with LTM remedial option at regulatory negotiations, as appropriate.

Bioventing and natural contaminant attenuation with LTM were evaluated during this TS. All hydrogeologic and groundwater chemical data necessary to evaluate these remedial options were collected under this program; however, the field work conducted under this program was oriented toward the collection of hydrogeologic data to be used as input into the Bioplume II groundwater model in support of intrinsic remediation with LTM for restoration of fuel-hydrocarbon-contaminated groundwater.

This report contains nine sections, including this introduction, and four appendices. Section 2 summarizes site characterization activities. Section 3 summarizes the physical characteristics of the study area. Section 4 describes the nature and extent of soil and groundwater contamination and the geochemistry of soil and groundwater at the site. Section 5 describes the Bioplume II model and design of the conceptual model for the site, lists model assumptions and input parameters, and describes sensitivity analyses, model output, and the results of the Bioplume II modeling. Section 6 presents a comparative analysis of remedial alternatives. Section 7 presents the LTM plan for the site. Section 8 presents the conclusions of this work and provides recommendations for further work at the site. Section 9 lists the references used to develop this document. Appendix A contains CPT logs, monitoring point completion diagrams, and slug test results. Appendix B presents soil and groundwater analytical results. Appendix C contains model input and calculations related to model calibration, and Appendix D contains Bioplume II model results in ASCII format on a diskette.

1.2 FACILITY BACKGROUND

Patrick AFB lies on a narrow barrier island off the eastern coast of Florida in Brevard County (Figure 1.1). Site ST-29 (Figure 1.2) is located in the north-central section of Patrick AFB and is approximately 400 feet west of the northeastern end of the northeast/southwest (NE/SW) runway. The BX Service Station has been in operation since 1954. The site consists of a small food market (Building 736), a gasoline dispensing area, and a car wash facility (Building 737). Four 10,000-gallon fiberglass MOGAS underground storage tanks (USTs) and one 1,000-gallon waste oil aboveground storage tank (AST) are currently used to dispense or store petroleum products.

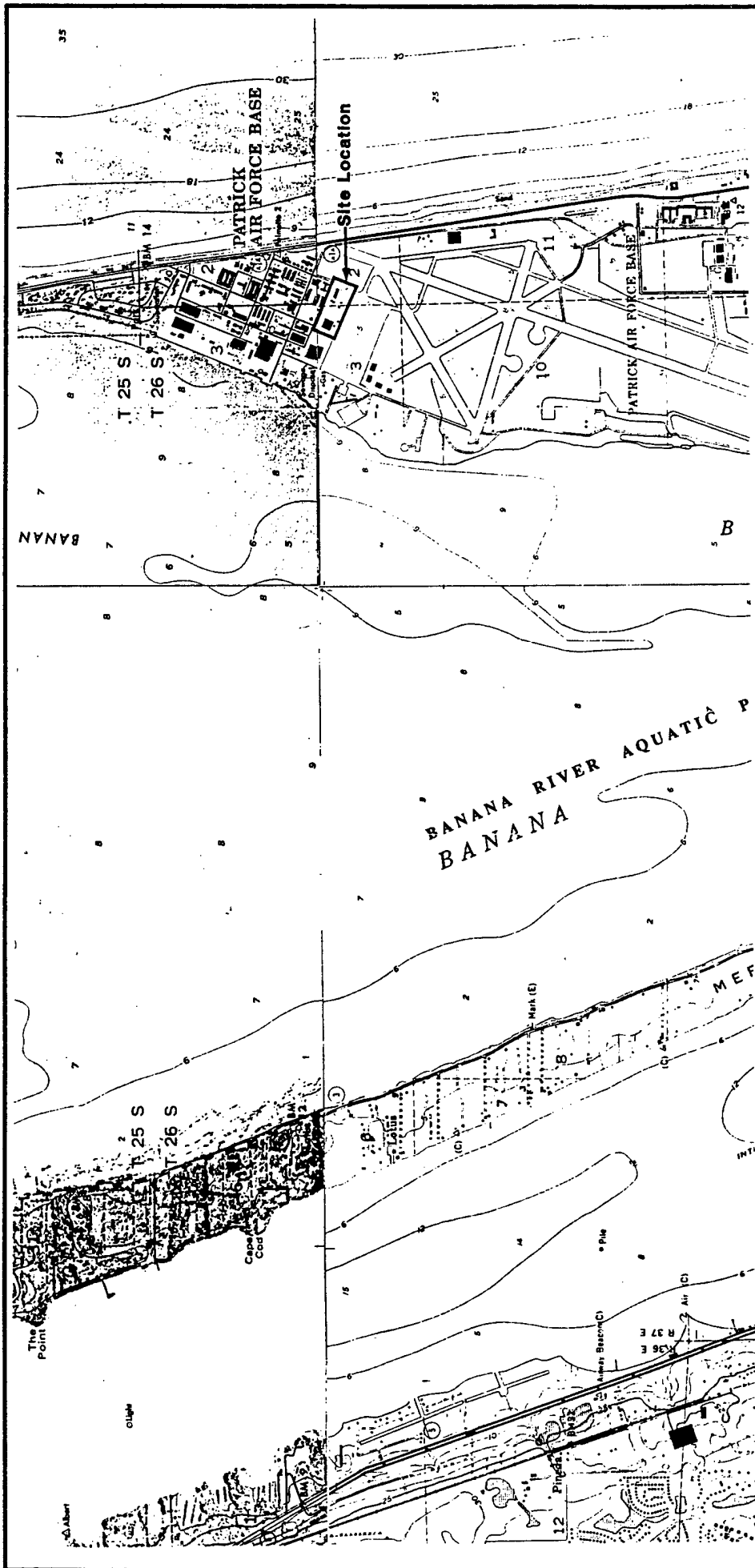
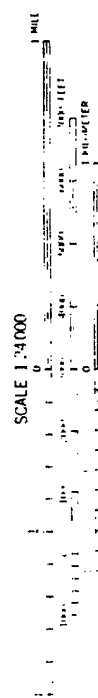
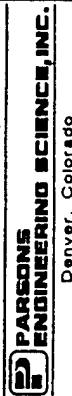

FIGURE 1.1

SITE LOCATION

Site ST-29
 Intrinsic Remediation TS
 Patrick Air Force Base, Florida



COURT INTERVAL 5 FEET
 NATIONAL GEODETIC VERTICAL DATUM OF 1929
 DEPTH CURVES AND SOUNDINGS IN FEET DATUM IS MEAN LOWER LOW WATER
 THE RELATIONSHIP BETWEEN THE TWO DATUMS IS VARIABLE
 HAZARD ZONE MAPPING: THE APPROXIMATE LINE OF MEAN HIGH WATER
 NO PERSONS LIVES IN THIS AREA

UTM GRID AND 1983 MAGNETIC NORTH
 THE LOCATION OF THE SITE IS SHOWN

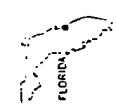

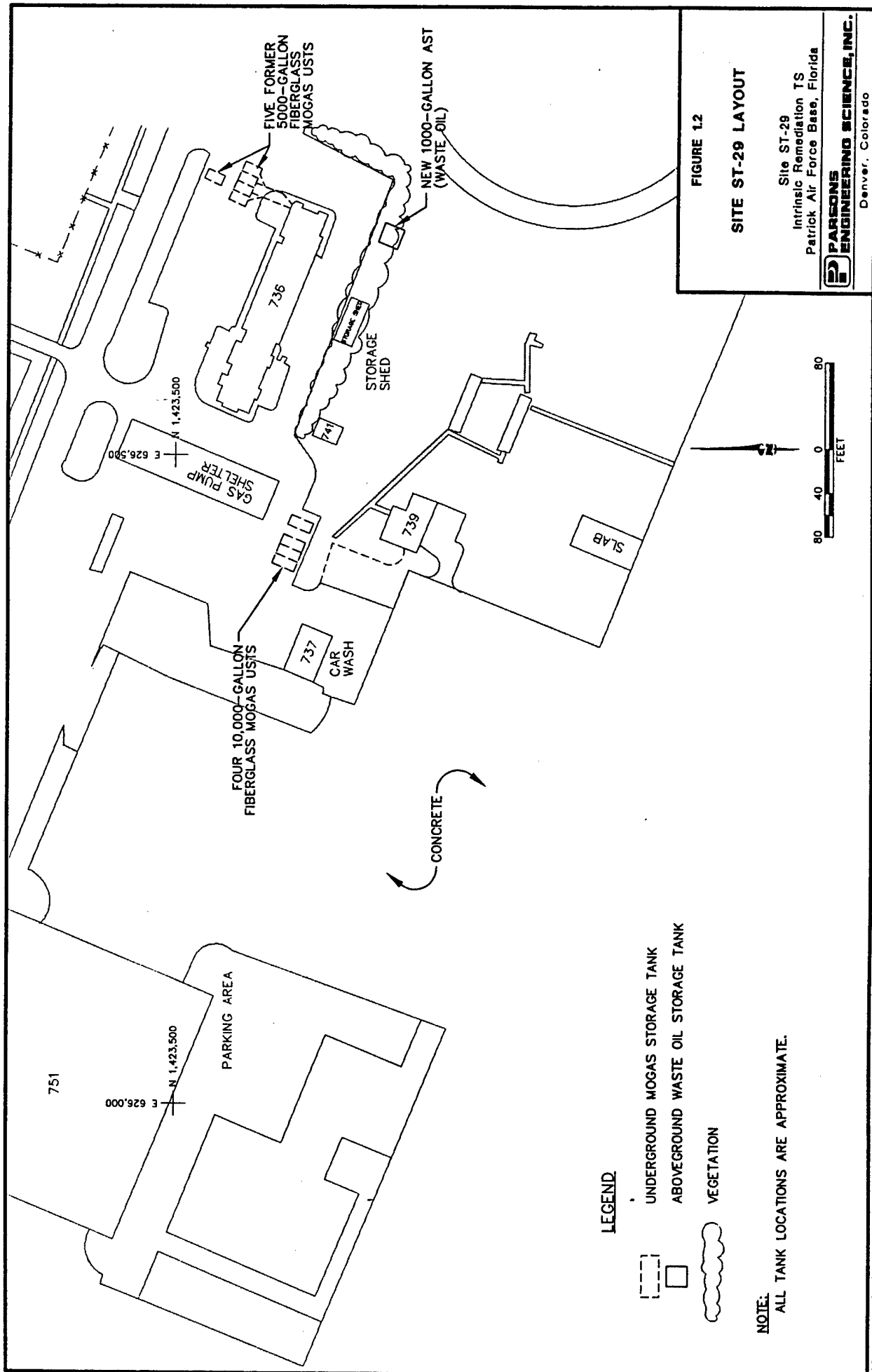
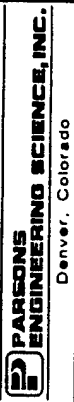

FIGURE 1.2

SITE ST-29 LAYOUT

Site ST-29
 Intrinsic Remediation TS
 Patrick Air Force Base, Florida



LEGEND

- UNDERGROUND MOGAS STORAGE TANK
- ABOVEGROUND WASTE OIL STORAGE TANK
- VEGETATION

NOTE:
 ALL TANK LOCATIONS ARE APPROXIMATE.

1.2.1 Operational and Site Investigation History

In 1973, five 5,000-gallon MOGAS USTs previously located northeast of Building 736 (the BX Service Station) were removed (Figure 1.2), and the excavations were backfilled with sand. In the same year, the MOGAS tanks were replaced with five 10,000-gallon fiberglass USTs. In 1985, one of the 10,000-gallon MOGAS USTs and product lines another of the 10,000-gallon fiberglass USTs were discovered to be leaking. Between 1985 and 1986, an estimated 700 gallons of unleaded gasoline was released into the subsurface as a result of the leaking lines and tank. In 1986, the leaking 10,000-gallon MOGAS UST was removed, leaving the four MOGAS USTs currently in operation. Records describing remedial activities conducted to mitigate the leaking tank and line were not available for review during preparation of this report. In February 1992, a 500-gallon waste oil UST was removed and replaced with the 1,000-gallon waste oil AST currently in use.

The Air Force Installation Restoration Program (IRP) was initiated at Patrick AFB in 1984 when the Air Force Engineering and Services Center (AFESC) retained Environmental Science & Engineering, Inc. (ESE) to conduct a records search of previous Base activities (Phase I of the IRP) (ESE, 1984). Phase II (stage 1) IRP work at Patrick AFB began in 1985 and consisted of monitoring well installation and collection and analysis of groundwater, soil, sediment, and surface water samples at a total of 16 sites (ESE, 1988). The BX Service Station (ST-29) was identified and added to the IRP during Phase II (stage 2) activities (ESE, 1988). Phase II (stage 2) work involved two sampling events to determine fluctuations in groundwater levels at the site. Round 1 sampling was conducted from late November 1988 to January 1989. Round 2 sampling was conducted from October to November 1989. A technical report documenting the results of stage 2 work was finalized in December of 1990 (ESE, 1991). A Phase II (stage 3) program at the BX Service Station was performed by O'Brien & Gere Engineers, Inc. (1992) in accordance with the Florida Department of Environmental Regulations (FDER) Petroleum Contamination Assessment (PCA) guidelines, as outlined in Chapters 17-770.600 and 17-770.630 of the Florida Administrative Code (FAC). The objective of the Phase II (stage 3) investigation was to evaluate the nature and extent of contamination at the site and to make remedial recommendations. A finalized report of the Phase II (stage 3) study was not available at the time this work plan was written.

A soil gas survey was conducted by ES (1993) at the BX Service Station in January 1993, prior to installation of a bioventing pilot test system. A 20-foot by 20-foot grid was laid out

in the field area where previous sampling had determined that soil hydrocarbon contamination was present. Total volatile petroleum hydrocarbons (TVPH) exceeded 10,000 parts per million, volume per volume (ppmv) at locations adjacent to the north and east sides of the car wash (Building 737) at Site ST-29.

1.2.2 Current Remedial Activities

A pilot-scale bioventing system is currently in place to treat the soil contamination north and east of the car wash. Initial results from this pilot test have been promising, with excellent biodegradation rates measured throughout a 3,000-square-foot area north of Building 737. Details regarding this system are presented in a bioventing work plan and interim results report (ES, 1993).

SECTION 2

SITE CHARACTERIZATION ACTIVITIES

This section presents the methods used by Parsons ES and researchers from the RSKERL to collect site-specific data at Patrick AFB, Florida. The majority of the site characterization data obtained under this program were collected in March 1994. In addition to the March 1994 site characterization activities, groundwater samples were collected in monitoring points and monitoring wells in March 1995 by RSKERL researchers and in May 1995 by CH2M Hill. To meet the requirements of the intrinsic remediation demonstration, several investigative techniques, including soil and groundwater sampling and aquifer testing, were utilized. CPT was used to collect stratigraphic information, and to collect soil samples. Previous investigations conducted at the site utilized standard hollow-stem auger (HSA) drilling and soil sampling. Groundwater samples were collected at monitoring points installed in CPT holes, and at previously installed monitoring wells. Previous investigations utilized monitoring wells installed in HSA boreholes. Aquifer slug tests were conducted in existing wells.

Data collected under this program were integrated to develop the conceptual site model and to aid interpretation of the physical setting (Section 3) and contaminant distribution (Section 4). The physical and chemical hydrogeologic data listed below were collected during the field work phase of the TS:

- Depth from measurement datum to the water table or potentiometric surface in monitoring wells and monitoring points;
- Location of potential groundwater recharge and discharge areas;
- Hydraulic conductivity as determined through slug tests;
- Stratigraphic analysis of subsurface media;
- Estimation of extent and thickness (if present) of mobile LNAPL;
- Dissolved oxygen (DO), nitrate, ferrous iron, sulfate, chloride, and total organic carbon (TOC) concentrations in groundwater;

- Temperature, specific conductance, reduction/oxidation (redox) potential, total alkalinity, and pH of groundwater;
- BTEX and trimethylbenzene (TMB) concentrations in groundwater; and
- BTEX and TMB concentrations in soil.

The following sections describe the procedures that were followed when collecting site-specific data. The applied CPT, soil sampling, and groundwater monitoring point installation and development procedures are described in Section 2.1. Procedures for sampling existing monitoring wells and newly installed monitoring points are described in Section 2.2. Aquifer testing procedures are described in Section 2.3.

2.1 CONE PENETROMETRY, MONITORING POINT INSTALLATION, AND SOIL SAMPLING ACTIVITIES

CPT-related activities took place between March 22 and March 31, 1994. CPT, soil sampling, and groundwater monitoring point installation were accomplished using the procedures described in the following sections and in the site-specific work plan.

Subsurface conditions at Site ST-29 were characterized using CPT coupled with laser-induced fluorescence (LIF). Cone penetrometry is an expeditious and effective means of analyzing the stratigraphy at a site by measuring the resistance of different soil types against the conical probe of the penetrometer as it is pushed into the subsurface. The resistance on the pressure tip and friction sleeves on the side of the cone is then correlated to soil cores collected to calibrate the CPT readings to the lithologies present at the site. Methodologies for the collection of soil core data are described in Section 2.1.3. The purpose of the LIF/CPT sampling at Site ST-29 was to determine subsurface stratigraphy and to help delineate the extent of mobile LNAPL (if present) and dissolved BTEX plumes.

CPT was conducted using the Applied Research Associates, Inc. (ARA) cone penetrometer truck, which consists of an instrumented probe that is forced into the ground using a hydraulic load frame mounted on a truck, with the weight of the truck providing the necessary reaction mass. The penetrometer equipment is mounted inside an 18-foot van body attached to a 10-wheel truck chassis with a turbo-charged diesel engine. Ballast in the form of metal weights and a steel water tank, which can hold 5,000 pounds of water, is added to the

truck to achieve an overall push capability of 45,000 pounds. Penetration force is supplied by a pair of large hydraulic cylinders bolted to the truck frame.

The penetrometer probe is of standard dimensions, having a 1.405-inch outside diameter (OD), 60-degree conical tip, and a 1.405-inch OD by 5.27-inch-long friction sleeve. A pressure gauge located above the cone tip monitors the pore water pressure so that corrected estimates of water depth and permeability can be made. Inside the probe, two load cells independently measure the vertical resistance against the conical tip and the side friction along the sleeve. Each load cell inside the probe is a cylinder of uniform cross section that is instrumented with four strain gauges in a full-bridge circuit. Forces are sensed by the load cells, and the data are transmitted from the probe assembly via a cable running through the push tubes. The analog data are digitized, recorded, and plotted by computer in the penetrometry truck. The penetrometer is usually advanced vertically into the soil at a constant rate of 48 inches per minute, although this rate must sometimes be reduced (e.g., when hard layers are encountered). The magnitude of the penetration pore pressure is a function of compressibility and, most importantly, permeability. Penetration, dissipation, and resistivity data will be used to determine soil types as they are encountered in the field.

The known propensity of aromatic or chlorinated hydrocarbons to fluoresce under ultraviolet wavelengths has allowed the use of LIF technology in conjunction with CPT technology to detect soil characteristics and hydrocarbon contamination simultaneously. The LIF/CPT system has a sapphire window in the side of the CPT pressure cone that allows a laser to scan the soil for fluorescent compounds as the LIF/CPT rod is pushed through soil. Assuming that aromatic hydrocarbons are simultaneously solvenated with other fuel-hydrocarbon constituents, the magnitude of aromatic fluorescence is indicative of hydrocarbon contamination in a soil matrix. A fiber optic cable connected to the laser spectrometer, and a 6-pair electrical conductor connected to the CPT data acquisition system, are routed through the interior of the push tubes to the CPT probe.

The basic laser system components of the CPT/LIF instrumentation are a Nd:YAG[®] pump laser, two separate and independent dye lasers, frequency-doubling crystals that convert the visible-dye laser output to ultraviolet, a fiber optic probe, a monochromator for wavelength resolution of the return fluorescence, a photomultiplier tube to convert photons into an electrical signal, a digital oscilloscope for waveform capture, and a control computer. The fiber optic probe for the cone penetrometer consists of a delivery and collection fiber, a

protective sheath, a fiber optic mount within the cone, and a sapphire window (Figure 2.1). The uphole portion of the system is adaptable to either groundwater monitoring fiber optic probes or an optical cone penetrometer probe. Optimal wavelengths to be used during a continuous CPT push are determined from initial data. Wavelength is selected to give the strongest fluorescence signal that can be attributed to the presence of contamination. Past experience suggested that a wavelength of less than 275 nanometers (nm) may be appropriate for detecting the fluorescence of BTEX.

2.1.1 CPT and Groundwater Monitoring Point Locations

CPT and/or groundwater monitoring point installation was performed at 25 locations in the vicinity of Site ST-29. All CPT and/or monitoring point locations are indicated on Figure 2.2, except for location CPT-25. CPT-25 was installed approximately 400 feet south-southwest of the BX Service Station (Building 736). At 23 of the 25 sites, groundwater monitoring points were installed. At the remaining two CPT sites, only soil characteristics and LIF data were recorded. Multiple groundwater monitoring points (with screens at different depths) were installed at several of the CPT locations. At eight of the locations where monitoring points were installed, the CPT unit was used only to install the points; no soil data were collected due to a failure in the probe instrumentation. Soil samples for laboratory analysis were collected at eight of the sites. Table 2.1 summarizes the CPT-related activity undertaken at each location. CPT locations were selected to provide the hydrogeologic data necessary for successful implementation of the Bioplume II model.

2.1.2 Groundwater Monitoring Point Installation Procedures

This section describes the procedures and equipment used for installation of new groundwater monitoring points with the CPT apparatus.

2.1.2.1 Pre-Installation Activities

All necessary digging, drilling, and groundwater monitoring well installation permits were obtained prior to mobilizing to the field. In addition, all utility lines were located, and proposed drilling locations were cleared prior to any drilling activities.

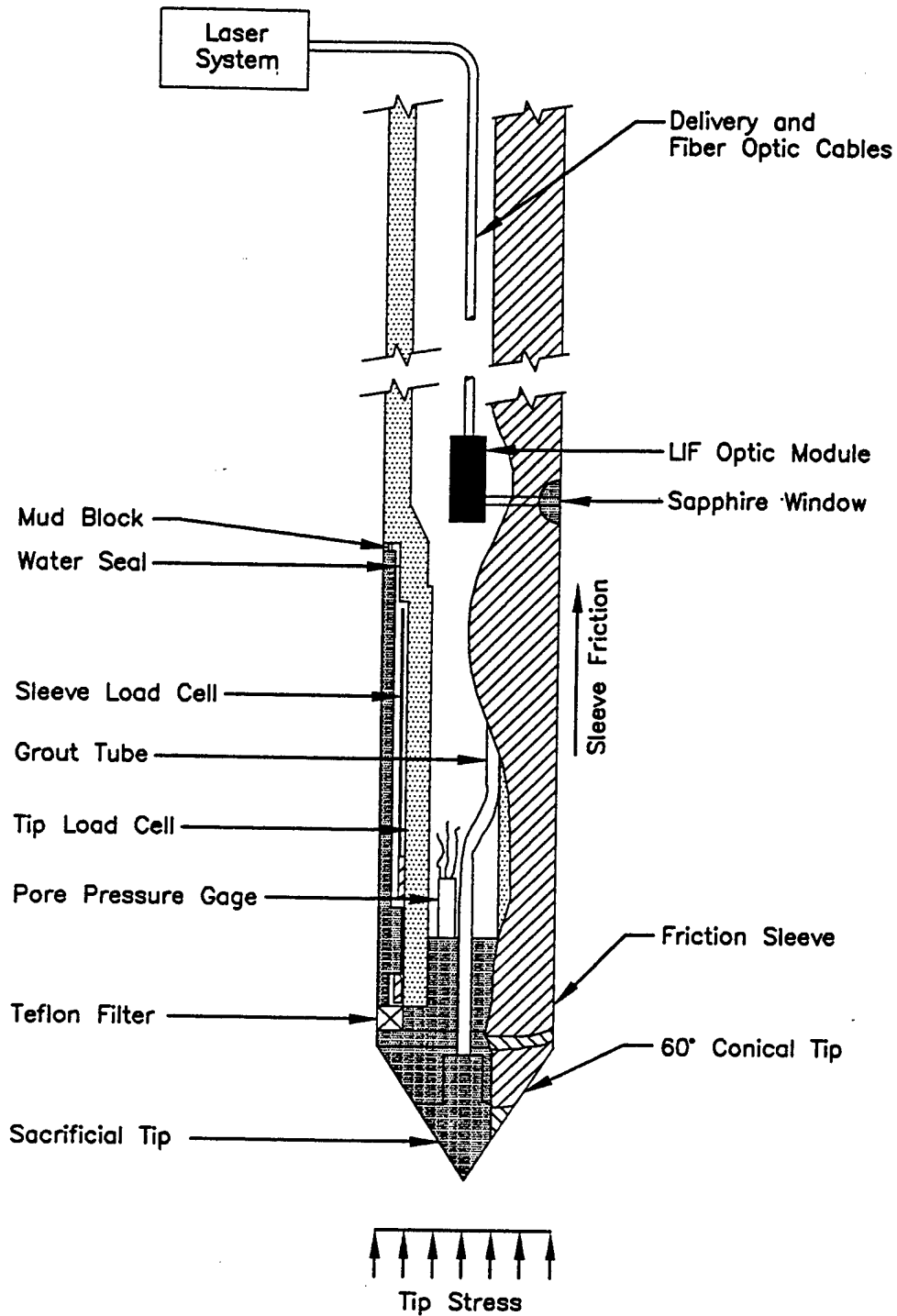

FIGURE 2.1
SCHEMATIC OF LASER-INDUCED
FLUORESCENCE CONE
PENETROMETER PROBE

Site ST-29
 Intrinsic Remediation TS
 Patrick Air Force Base, Florida

PARSONS
ENGINEERING SCIENCE, INC.

Denver, Colorado

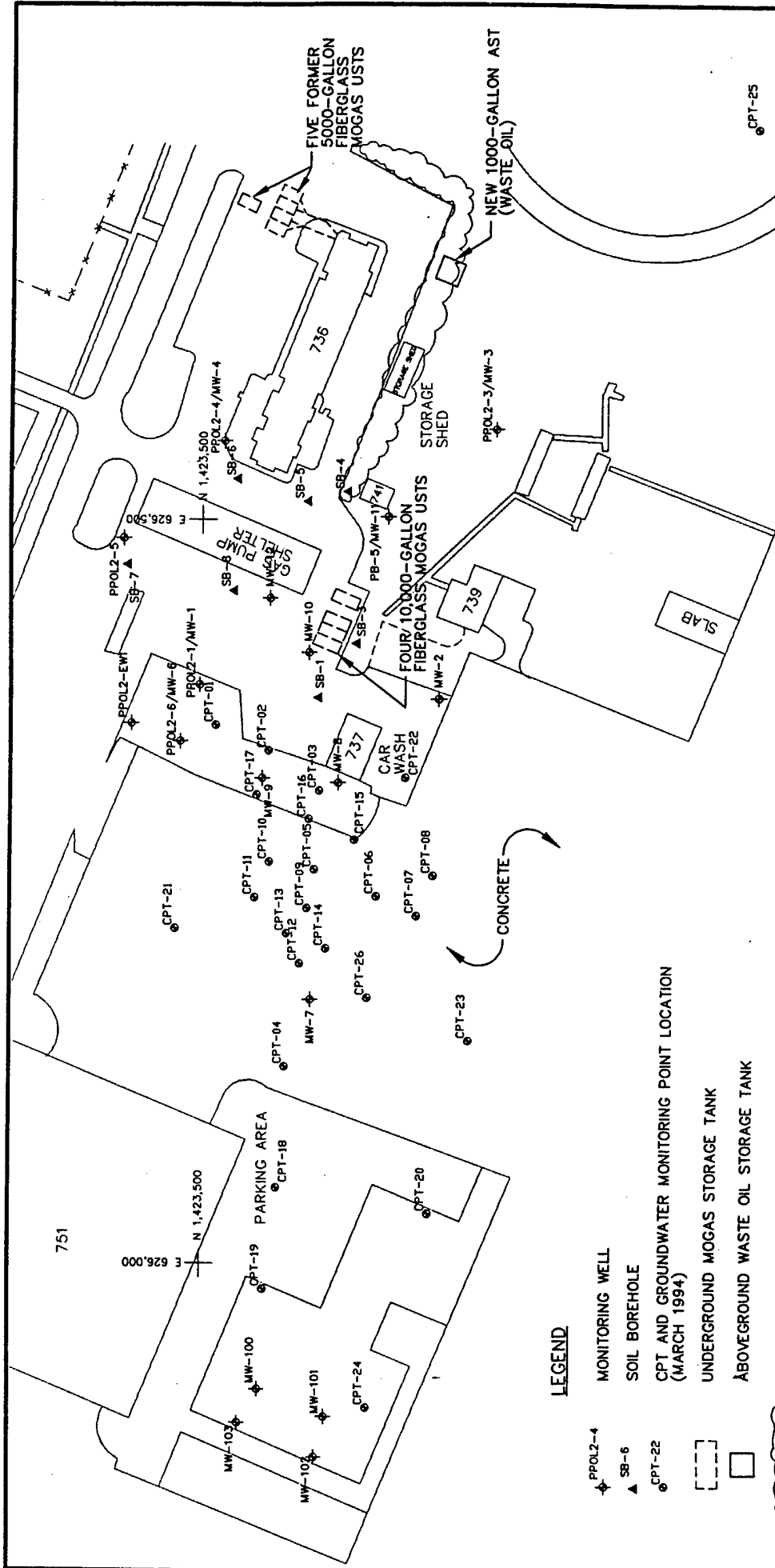

FIGURE 2.2
SITE ST-29
SAMPLING LOCATIONS
 Site ST-29
 Intrinsic Remediation TS
 Patrick Air Force Base, Florida
PARSONS
ENGINEERING SCIENCE, INC.
 Denver, Colorado

LEGEND

- ◆ PPOL2-4 MONITORING WELL
- ▲ SB-6 SOIL BOREHOLE
- CPT-22 CPT AND GROUNDWATER MONITORING POINT LOCATION (MARCH 1994)
- ▭ UNDERGROUND MOGAS STORAGE TANK
- ABOVEGROUND WASTE OIL STORAGE TANK
- ☁ VEGETATION

NOTE:
 ALL TANK LOCATIONS ARE APPROXIMATE.

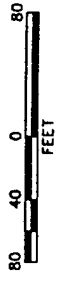

TABLE 2.1

**CPT ACTIVITY SUMMARY
SITE ST-29 INTRINSIC REMEDIATION TS
PATRICK AFB, FLORIDA**

Location	Northing	Easting	Ground Elevation (ft msl) ^{a/}	Total Depth (ft bgs) ^{b/}	Depth to Top of Screen (ft bgs)	Depth to Base of Screen (ft bgs)	CPT Profile Available?	Soil Sample Intervals (ft bgs)
CPT-01	626491	1423363	7.02	8.28	5	8.28	Y	NS ^{c/}
CPT-02S	626455	1423346	7.07	8.04	4.37	7.65	Y	4 - 5
CPT-86-002D	626455	1423346	7.07	13.42	10.14	13.42	Y	5 - 6 6 - 6.45 6.45 - 6.67 6.67 - 7 7 - 8
CPT-03S	626420	1423319	6.55	8.19	4.592	7.872	Y	3 - 4.5
CPT-03M	626420	1423319	6.55	14.1	10.82	14.1	Y	4.5 - 5.5
CPT-03D	626420	1423319	6.55	19.45	15.762	19.042	Y	5.5 - 6.5 6.5 - 7
CPT-04S	626443	1423133	6.57	10	6.64	9.92	Y	NS
CPT-04D	626443	1423133	6.57	11.92	8.26	11.54	Y	NS
CPT-05S	626423	1423266	6.26	8	4.72	8	Y	3.33 - 3.92 4.17 - 4.75 5.00 - 5.58 5.33 - 5.83
CPT-06S	626381	1423248	6.26	8	4.72	8	Y	NS
CPT-07S	626354	1423235	6.36	1.44	5.12	1.44	Y	NS
CPT-08S	626343	1423262	6.48	8	4.72	8	Y	NS
CPT-09S	626428	1423240	6.35	7.98	4.72	8	Y	2.5 - 3.5
CPT-09D	626428	1423240	6.35	15	11.72	15	Y	3.5 - 4.5 4.5 - 5.5 5.5 - 6.5
CPT-10S	626454	1423271	6.26	8	4.72	8	Y	NS
CPT-11S	626464	1423247	6.37	8	4.72	8	Y	NS
CPT-12S	626433	1423203	6.43	8.09	4.72	8	Y	NS
CPT-12D	626433	1423203	6.43	16	12.72	16	Y	NS
CPT-13S	626442	1423223	6.41	17.49	14.21	17.49	Y	4.5 - 6.5
CPT-14D	626415	1423213	6.36	16.73	13.45	16.73	Y	NS
CPT-15				19.39				3 - 4 4 - 5 5 - 6 5.5 - 6.5

TABLE 2.1 (CONCLUDED)

**CPT ACTIVITY SUMMARY
SITE ST-29 INTRINSIC REMEDIATION TS
PATRICK AFB, FLORIDA**

Location	Northing	Easting	Ground Elevation (ft msl) ^{a/}	Total Depth (ft bgs) ^{b/}	Depth to Top of Screen (ft bgs)	Depth to Base of Screen (ft bgs)	CPT Profile Available?	Soil Sample Intervals (ft bgs)
CPT-16S	626427	1423300	6.14	8	4.72	8	Y	3 - 5.35
CPT-16DD	626427	1423300	6.14	45	41.72	45	Y	5.35 - 6.53 6.53 - 7.7
CPT-17				14.60			Y	2 - 3 3 - 4 4 - 5 5 - 6
CPT-18S	626448	1423051	6.58	7.87	4.72	8	N	NS
CPT-18D	626448	1423051	6.58	16	12.72	16	N	NS
CPT-18DD	626448	1423051	6.58	40	36.72	40	N	NS
CPT-19S	626457	1422983	6.39	8	4.72	8	N	NS
CPT-19D	626457	1422983	6.39	16	12.72	16	N	NS
CPT-20S	626345	1423034	6.4	8	4.72	8	N	NS
CPT-20D	626345	1423034	6.4	16	12.72	16	N	NS
CPT-21S	626518	1423226	6.49	7.9	4.72	8	N	NS
CPT-21D	626518	1423226	6.49	15.3	12.02	15.3	N	NS
CPT-22S	626362	1423328	6.75	7.9	4.77	8.05	Y	NS
CPT-22D	626362	1423328	6.75	10.2	10.17	13.45	Y	NS
CPT-23S	626319	1423151	6.57	6.94	3.72	7	N	NS
CPT-23D	626319	1423151	6.57	13.43	10.22	13.5	N	NS
CPT-24S	626386	1422903	5.89	6.46	3.22	6.5	N	NS
CPT-24D	626386	1422903	5.89	12.94	9.72	13	N	NS
CPT-25S	626129	1423761	6.6	6.47	3.22	6.5	N	NS
CPT-25D	626129	1423761	6.6	12.83	9.72	13	N	NS
CPT-26S	626387	1423180	6.47	6.87	3.72	7	N	NS
CPT-26D	626387	1423180	6.47	13.41	10.22	13.5	N	NS

^{a/} ft msl = feet above mean sea level.

^{b/} ft bgs = feet below ground surface.

^{c/} NS = no soil sample collected

Water used in equipment cleaning or grouting was obtained from an onsite potable water supply. Water use approval was verified by contacting the appropriate facility personnel.

2.1.2.2 Equipment Decontamination Procedures

After sampling at each CPT location, CPT push rods were cleaned with ARA's CPT steam-cleaning system (rod cleaner) as the rods were withdrawn from the ground. A vacuum system located beneath the CPT truck was used to recover cleaning water. Use of this system resulted in nearly 100-percent recovery of steam-cleaning rinseate from the rod cleaner. Rinseate was generated only as the rods moved past the cleaner, thereby minimizing liquid waste generation. Rinseate was collected in 55-gallon drums provided by ARA. Filled 55-gallon drums were then emptied into a 6,000-gallon hazardous waste collection tank used as a Base-wide disposal tank for Patrick AFB operations.

Potable water to be used in CPT equipment cleaning, decontamination, or grouting was obtained from one of the Base water supplies. Water use approval was verified by contacting the appropriate facility personnel. Precautions were taken to minimize any impact to the surrounding area that might result from decontamination operations.

Fuel, lubricants, and other similar substances were handled in a manner consistent with accepted safety procedures and standard operating practices. Well completion materials were not stored near or in areas which could be affected by these substances.

2.1.2.3 Monitoring Point Installation

Groundwater monitoring points were installed at several locations under this program. Detailed well installation procedures are described in the following paragraphs. At most locations, two or three separate points (each screened at different depths) were installed. At each location, the point with the shallowest screened interval was designated with the suffix "S", while the deep point was designated with the suffix "D" (e.g., CPT-02S or CPT-02D). At CPT-03, CPT-16, and CPT-18, three points were installed. At CPT-03, the intermediate point was called CPT-03M, while at CPT-16 and CPT-18, the intermediate points were given the "D" suffix and the deepest points were given the suffix "DD". Well completion diagrams are included in Appendix A.

2.1.2.3.1 Monitoring Point Materials Decontamination

Well completion materials were inspected by the field hydrogeologist and determined to be clean and acceptable prior to use. All well completion materials were factory sealed. Materials were inspected for possible external contamination before use. Materials that could not be cleaned to the satisfaction of the field hydrogeologist were not used.

2.1.2.3.2 Monitoring Point Screen and Casing

Upon completion of CPT to the proper termination depth, monitoring point casing was installed. Construction details were noted on a Monitoring Point Installation Record form. This information became part of the permanent field record for the site.

Blank well casing was constructed of either Schedule 40 polyvinyl chloride (PVC) with an inside diameter (ID) of 0.5 inch or Teflon[®] tubing with an ID of 0.25 inch. All well casing sections were flush-threaded; glued joints were not used. The casing or tubing at each well was fitted with a top cap constructed of the same type of material as the casing/tubing. The top cap was vented to maintain ambient atmospheric pressure within the well casing. The purpose of using the Teflon[®] tubing was to field test the ability to connect this tubing directly to the PVC screen and successfully obtain a groundwater sample via the tubing.

Well screens were constructed of flush-threaded, Schedule 40 PVC with an ID of 0.5 inch. The screens were factory slotted with 0.010-inch openings. Where blank casing was also 0.5-inch ID, the screen was threaded to the casing. For the points where a Teflon[®] tube was used, a brass pipe fitting was used to connect the screen and the tube. Each well had a 1-meter screen. The position of the screen was selected by the field hydrogeologist after consideration was given to the geometry and hydraulic characteristics of the stratum in which the wells were screened.

The field hydrogeologist verified and recorded the hole depth and the lengths of all casing sections. All lengths and depths were measured to the nearest 0.1 foot.

2.1.2.3.3 Flush-Mount Protective Cover

Each monitoring point was completed with an at-grade protective cover. In areas with pavement, the at-grade covers were cemented in place using concrete blended to the existing

pavement. All wells were completed with concrete pads that slope gently away from the protective casing to facilitate runoff during precipitation events.

2.1.2.4 Monitoring Point Development

Before being sampled, newly installed monitoring points were developed. Well development removes sediment from inside the well casing and flushes fines, cuttings, and drilling fluids from the sand pack and the portion of the formation adjacent to the well screen.

Monitoring point development was accomplished using a peristaltic pump. In points with PVC casing, the pump tubing was regularly lowered to the bottom of the well so that fines were agitated and removed from the well in the development water. For points with Teflon[®] tubing as the well casing, the pump was attached to the tubing and used to remove water. Development was continued until a minimum of 10 casing volumes of water were removed from the well and the pH, temperature, specific conductivity, DO concentration, and redox potential of the groundwater had stabilized. All well development waters were collected in 55-gallon drums and transported to the Patrick AFB waste collection tank.

2.1.2.5 Water Level Measurements

Water levels were measured at monitoring points with PVC casing. Measurements were made using an electric water level probe capable of recording to the nearest 1/8 inch (0.01 foot). Water levels could not be measured in points constructed with Teflon[®] casing because the casing was too small to accommodate the water level probe. Additional water level measurements were also made in several existing monitoring wells, although these measurements were not collected on the same day as measurements made at monitoring points.

2.1.2.6 Well Location and Datum Survey

The location and elevation of the new wells were surveyed by ARA personnel soon after well completion. The horizontal locations were measured relative to established Patrick AFB coordinates. Horizontal coordinates were measured to the nearest 1 foot. Vertical location of the adjacent ground surface was measured relative to a US Geological Survey (USGS) mean sea level (msl) datum. The ground surface elevation was measured to the nearest 0.01 foot,

and the distance from the ground surface to the measurement datum was later measured to the nearest 0.01 foot by hand. Survey results are presented in Table 2.1.

2.1.3 Soil Sampling

Soil samples were obtained from eight CPT holes (Table 2.1) using a Mostap-35[®] sampling device. The sampler is coupled to the penetrometer rod and pushed into the soil with the same equipment used for CPT/LIF. While the Mostap-35[®] cone is in position, soil is prevented from entering the sampling tube until the desired depth is achieved. After the sampler was pushed to the depth at which the soil sample was to be taken, the sampling unit was raised a few inches, and the Mostap-35[®] apparatus was unlocked. After unlocking the Mostap-35[®] attachment, a soil section was cut, and the sampling apparatus was pulled from the ground as quickly as possible. The Mostap-35[®] sampling apparatus allowed collection of 2-foot-long continuous samples. Recovery efficiencies for samples in saturated soils were occasionally reduced because of spillage of the soil from the device after extraction. To mitigate this problem, soil samples were compressed *in situ* with the penetrometer and Mostap assembly to expel the pore water before extraction. Compressed soil samples were then extracted and measured to give a description of the soil stratigraphy accurate for the length of soil core taken.

Soil samples collected for laboratory analysis were removed from the sampler and placed in clean glass jars. In addition to samples collected with the CPT, shallow soil stratigraphy was examined at two locations (CPT-3 and CPT-5) by digging test holes with a post-hole digger. Soil sample locations and depths are summarized on Table 2.1.

Parsons ES field personnel observed CPT and monitoring point installation activities and maintained a log documenting any unusual conditions encountered during installation. ARA kept logs of CPT instrument readings and presented the results as strip charts in their report on site activities (Gildea *et al.*, 1994). Final CPT logs are presented in Appendix A. These logs indicate lithologic characteristics and contacts as indicated by CPT readings, as well as sample intervals and laboratory results for total BTEX analyses.

All soil sampling tools were cleaned onsite prior to use and between each sampling event with a clean water/phosphate-free detergent mix and a clean water rinse. All decontamination

activities were conducted in a manner so that the excess water was contained and properly disposed of.

2.2 GROUNDWATER SAMPLING

This section describes the procedures used for collecting groundwater quality samples in March 1994. Groundwater sampling conducted at this time followed established USEPA procedures, as did the groundwater sampling that occurred in March 1995. The sampling protocol followed by CH2M Hill during the May 1995 sampling event was not available at the time of this report. In order to maintain a high degree of quality control during this sampling event, the procedures described in the following sections were followed during the March 1994 sampling event.

Groundwater samples were collected during and after installation of monitoring points. Existing wells were sampled by Parsons ES and/or RSKERL personnel while new monitoring points were being installed. Sampling of monitoring wells and points is described in Section 2.2.3.1. Sample analysis was performed by USEPA RSKERL personnel.

Activities that occurred during groundwater sampling are summarized below:

- Assembly and preparation of equipment and supplies;
- Inspection of the well integrity (for monitoring well sampling), including
 - Protective cover, cap, and lock,
 - External surface seal and pad,
 - Well stick-up, cap, and datum reference, and
 - Internal surface seal;
- Groundwater sampling, including
 - Water level measurements,
 - Visual inspection of water,
 - Well casing or monitoring point evacuation, and
 - Sampling;
- Sample preservation and transport, including
 - Sample preparation,
 - Onsite measurement of physical parameters,
 - Sample labeling,

- Transport of samples to the onsite USEPA mobile laboratory;
- Completion of sampling records; and
- Sample disposition.

Detailed groundwater sampling and sample handling procedures that were used are presented in following sections.

2.2.1 Groundwater Sampling Locations

Groundwater samples were collected from existing monitoring wells and from newly installed groundwater monitoring points.

2.2.1.1 Monitoring Well Sampling Locations

Groundwater samples were collected from seven existing monitoring wells. Existing wells that were sampled include MW-100 through MW-103 (installed as part of the monitoring system for a UST site present to the west of Site ST-29), PB-5, PPOL2-1, and PPOL2-6. These wells were sampled using a peristaltic pump with dedicated polyethylene tubing. Locations of these wells are indicated on Figure 2.2.

2.2.1.2 Monitoring Point Locations

Groundwater samples were collected from 41 monitoring points at 23 locations. After completion of installation and development activities, monitoring points were sampled using a peristaltic pump and dedicated tubing (where needed). Locations of groundwater monitoring points are indicated on Figure 2.2.

2.2.2 Preparation for Sampling

All equipment used for sampling was assembled and properly cleaned and calibrated (if required) prior to arriving in the field. In addition, all record-keeping materials were gathered prior to leaving the office.

2.2.2.1 Equipment Cleaning

All portions of sampling and test equipment that contacted the samples were thoroughly cleaned before use. This equipment included the water level probe and cable, lifting line, test equipment for onsite use, and other equipment that contacted the samples or was placed downhole. The following cleaning protocol was used:

- Cleaned with potable water and phosphate-free laboratory detergent;
- Rinsed with potable water;
- Rinsed with distilled or deionized water;
- Rinsed with reagent-grade acetone; and
- Air dried prior to use.

Any deviations from these procedures were documented in the field scientist's field notebook and on the groundwater sampling form.

2.2.2.2 Equipment Calibration

As required, field analytical equipment was calibrated according to the manufacturer's specifications prior to field use. This applied to equipment used for onsite chemical measurements of DO, redox potential, pH, specific conductivity, and temperature.

2.2.3 Sampling Procedures

Special care was taken to prevent contamination of the groundwater and extracted samples through cross contamination from improperly cleaned equipment. Water level probes and cable used to determine static water levels and well total depths were thoroughly cleaned before and after field use and between uses at different sampling locations according to the procedures presented in Section 2.2.2.1. In addition, a clean pair of new, disposable nitrile gloves was worn each time a different well was sampled.

2.2.3.1 Groundwater Monitoring Well and Monitoring Point Sampling

2.2.3.1.1 Preparation of Location

Prior to starting the sampling procedure, the area around the existing wells and new monitoring points was cleared of foreign materials, such as brush, rocks, and debris. This prevented sampling equipment from inadvertently contacting debris around the monitoring well/point.

2.2.3.1.2 Water Level and Total Depth Measurements

Prior to removing any water from the monitoring well or monitoring point, the static water level was measured. An electric water level probe was used to measure the depth to groundwater to the nearest 0.01 foot below the datum. After measuring the static water level, the water level probe was slowly lowered to the bottom of the monitoring well/point, and the total depth was measured to the nearest 0.01 foot. Based on these measurements, the volume of water to be purged from each monitoring well/point was calculated.

2.2.3.1.3 Monitoring Well/Point Purging

The volume of water contained within the monitoring well/point casing at the time of sampling was calculated, and at least three times the calculated volume was removed from the well/point. USEPA RSKERL and Parsons ES personnel monitored temperature and DO concentrations during purging, and purging continued until these parameters stabilized, and at least three casing volumes were removed. All purge water was placed in ARA-provided, 55-gallon drums and disposed of by ARA in the Patrick AFB 6,000-gallon hazardous waste collection tank. Emptied drums were rinsed with hot water and returned to Base personnel for reuse. A peristaltic pump was used for monitoring well and monitoring point purging.

2.2.3.1.4 Sample Extraction

Dedicated high-density polyethylene (HDPE) tubing and a peristaltic pump were used to extract groundwater samples from the monitoring wells and points. For points with Teflon[®] tubing/casings, the pump was attached directly to the casing. Where possible, the tubing was lowered through the casing into the water gently to prevent splashing. The sample was

transferred directly into the appropriate sample container(s), with water carefully poured down the inner walls of the sample bottle to minimize aeration of the sample.

Excess water collected during sampling was placed into the 55-gallon drums used for monitoring well/point purge waters and transported by ARA to the 6,000-gallon hazardous waste collection tank at Patrick AFB.

2.2.4 Onsite Chemical Parameter Measurement

2.2.4.1 Dissolved Oxygen Measurements

DO measurements were taken using an Orion[®] model 840 DO meter. DO concentrations were determined by extracting groundwater from the subsurface using a peristaltic pump, and running the extracted groundwater over the probe of the DO meter while the probe was immersed in an Erlenmeyer flask. This effectively produces a flow-through cell that minimizes aeration of the sample. DO concentrations were recorded after the readings stabilized and in all cases represent the lowest DO concentration observed.

2.2.4.2 Reduction/Oxidation Potential Measurements

Redox potential measurements were taken using an Orion[®] model 290A redox potential meter. Redox potential measurements were recorded after the readings stabilized and generally represent the lowest redox potential observed.

2.2.4.3 pH, Temperature, and Electric Conductance

Because the pH, temperature, and electric conductance of the groundwater change significantly within a short time following sample acquisition, these parameters were measured in the field or in the USEPA Mobile Laboratory immediately after sample collection. The measurements were made in a clean glass container separate from those intended for laboratory analysis, and the measured values were recorded on the groundwater sampling record.

2.2.5 Sample Handling

2.2.5.1 Sample Preservation

The USEPA Mobile Laboratory added any necessary chemical preservatives to sample containers prior to sampling.

2.2.5.2 Sample Container and Labels

Sample containers and appropriate container lids were provided by the USEPA Mobile Laboratory. The sample containers were filled as described in Section 2.2.3.1.4, and the container lids were tightly closed. The sample label was firmly attached to the container side, and the following information was legibly and indelibly written on the label:

- Facility name;
- Sample identification;
- Sample type (e.g., groundwater);
- Sampling date;
- Sampling time;
- Preservatives added; and,
- Sample collector's initials.

2.2.5.3 Sample Shipment

After the samples were sealed and labeled, they were packaged for transport to the onsite USEPA Mobile Laboratory. The following packaging and labeling procedures were followed:

- Sample was packaged to prevent leakage or vaporization from its container;
- Shipping container was labeled with
 - Sample collector's name, address, and telephone number;
 - Laboratory's name, address, and telephone number;
 - Description of sample;
 - Quantity of sample; and
 - Date of shipment.

The packaged samples were hand-delivered directly to the USEPA Mobile Laboratory. Delivery occurred shortly after sample acquisition.

2.3 AQUIFER TESTING

2.3.1 Slug Testing

Slug tests were conducted to estimate the hydraulic conductivity of the shallow saturated zone at Site ST-29. Slug tests are single-well hydraulic tests used to determine the hydraulic conductivity of an aquifer in the immediate vicinity of the tested well. Slug tests can be used for both confined and unconfined aquifers that have a transmissivity of less than 7,000 square feet per day (ft²/day). Slug testing can be performed using either a rising head or a falling head test. Rising head tests, which generally give more accurate results, were used at this site. Slug tests were performed in monitoring wells PPOL2-1, PPOL2-4, PPOL2-5, and PPOL2-6 (Figure 2.2). Detailed slug testing procedures are presented in the *Draft Technical Protocol for Implementing Intrinsic Remediation with Long-Term Monitoring for Natural Attenuation of Fuel Contamination Dissolved in Groundwater* (Wiedemeier *et al.*, 1995), hereafter referred to as the Technical Protocol document.

2.3.2 Slug Test Data Analysis

Data obtained during slug testing were analyzed using AQTESOLV software and the methods of Bouwer and Rice (1976) and Bouwer (1989) for unconfined conditions. The results of slug testing are presented in Section 3.3.

SECTION 3

PHYSICAL CHARACTERISTICS OF THE STUDY AREA

This section incorporates data collected during investigations summarized by ESE (1991) and O'Brien and Gere Engineers, Inc. (1992), and a more recent investigation conducted in March 1994, by Parsons ES in conjunction with researchers from the USEPA RSKERL to describe the physical characteristics of Site ST-29. The investigative techniques used by Parsons ES and RSKERL researchers to determine the physical characteristics of Site ST-29 are discussed in Section 2.

3.1 SURFACE FEATURES

3.1.1 Topography and Surface Water Hydrology

Patrick AFB lies on a long barrier island situated off Florida's east coast, in Brevard County. The City of Cocoa Beach is located immediately north of the Base, and Satellite Beach is directly south. Patrick AFB encompasses approximately 1,800 acres of coastal strip that is composed largely of relic beach deposits of the Cocoa-Sebastian Ridge of the Central Atlantic Coastal Strip in the Eastern Flatwoods Physiographic District.

The barrier island parallels the eastern Florida shoreline and is bounded on the east by the Atlantic Ocean and on the west by the Banana River (Figure 1.1). The widest section of the barrier island lies north of Patrick AFB at Cape Canaveral (width 4.5 miles). The island extends approximately 90 miles from Ponce de Leon Inlet south to Sebastian Inlet. Patrick AFB is 4.1 miles long (north to south), and its width varies from 800 feet at its northern end to 7,200 feet at its southern end. The highest elevations of Patrick AFB are located on sand dune features which lie inland from the Atlantic Ocean. These dunes form ridges with elevations of 10 to 20 feet above msl. Elevation of the land surface at the base varies from 0 to 20 feet msl. The land surface at the base slopes gently westward toward the shoreline of the Banana River (Figure 1.1).

The Site ST-29 vicinity has a generally level ground surface that varies from approximately 7 to 8 feet above msl. Portions of this area have been raised or leveled with fill. There are no surface water bodies located in the immediate vicinity of Site ST-29, and the bodies of surface water closest to the site are the Atlantic Ocean (750 feet east) and the Banana River (2,400 feet west) (Figure 1.1).

3.2 REGIONAL GEOLOGY AND HYDROGEOLOGY

Patrick AFB is situated on undifferentiated marine sands overlying the Pleistocene-age Anastasia Formation and Caloosahatchee Marl Formation; these three units comprise the surficial unconsolidated deposits in the area. Above the Caloosahatchee Marl, the surficial deposits form a shallow, unconfined aquifer. The Anastasia Formation is a discontinuous layer of undifferentiated sands with silt and shells that may not be present in this area. The Caloosahatchee Marl Formation consists primarily of calcareous sandy clay deposits.

Underlying the Caloosahatchee Formation is the Tamiami Formation, which is made up of limestones, marls, silty sands, and clay. The Tamiami Formation forms a shallow bedrock aquifer. The marine sands, clays, and limestones of the Hawthorn Formation underlie the Tamiami Formation. Interspersed limestone layers form localized aquifers within the Hawthorn Formation. Beneath the Hawthorn Formation is the Floridan Aquifer, which is comprised of Ocala Formation limestone and extends to a depth of over 1,500 feet below msl. Figure 3.1 shows the generalized stratigraphic sequence for the area.

The likelihood of contamination of the deep aquifers from sources in the shallow aquifer is assumed to be minimal. This is because the deep aquifers have sufficient pressure head to cause the potentiometric surface for the deep aquifers to be greater than that for the water table within the shallow unconfined aquifer, thus preventing vertical groundwater flow (and the associated migration of contaminants) from the shallow aquifer into the deeper units.

Patrick AFB receives its water from the City of Cocoa Beach, which is supplied by inland well fields screened in the Floridan aquifer in East Orange County. A backup water supply for Patrick AFB is supplied by the City of Melbourne. Patrick AFB maintains five standby potable water supply wells, primarily for fire suppression. These wells are screened in the limestones of the Ocala Formation (ESE, 1984). Groundwater in the surficial aquifer beneath Site ST-29 is classified as G-II based on Chapter 3 of the FAC regulations [designated as potable if less than 10,000 milligrams per liter (mg/L) of total dissolved solids (TDS) is present].

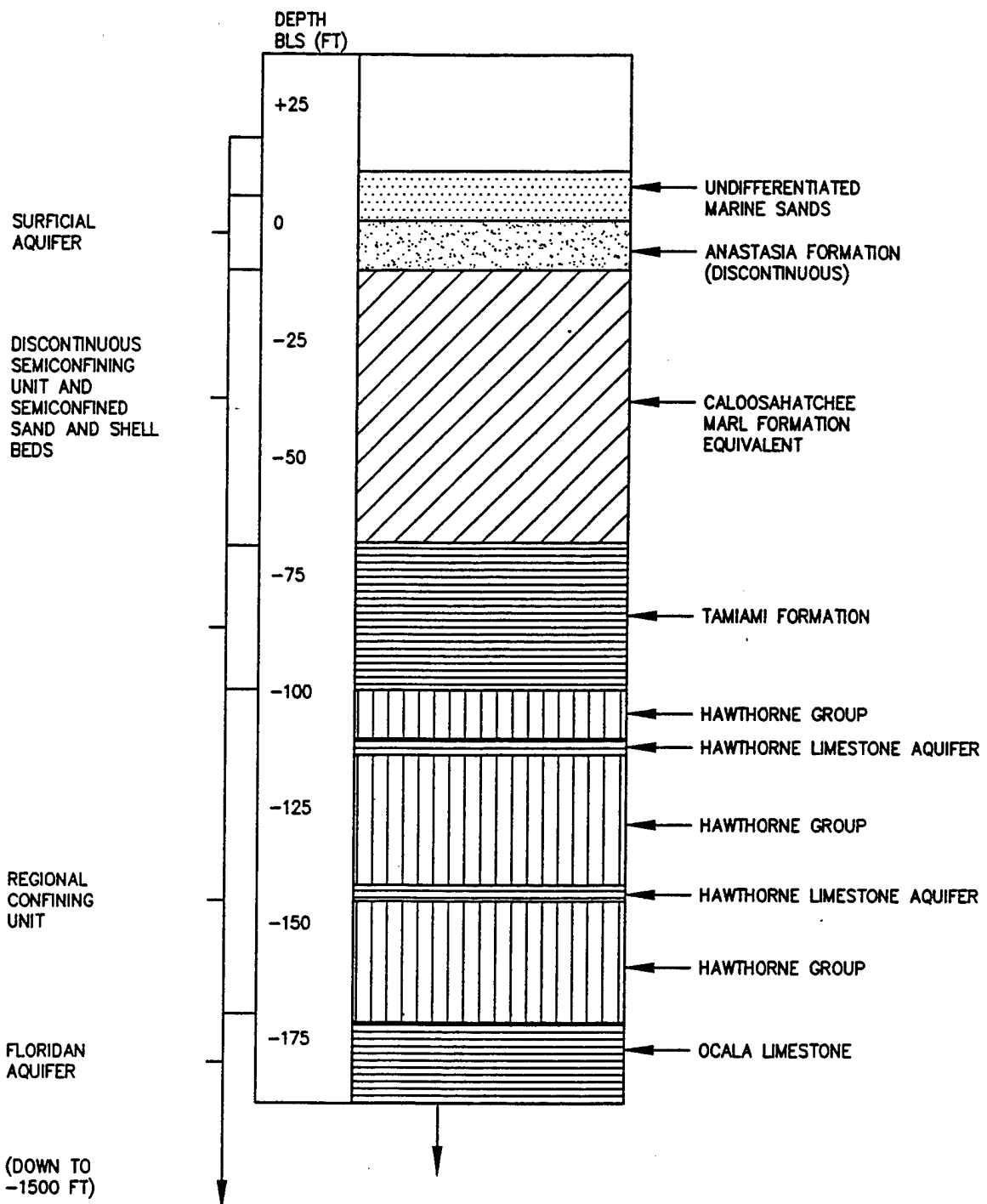

FIGURE 3.1

GENERALIZED STRATIGRAPHIC SEQUENCE

Site ST-29
 Intrinsic Remediation TS
 Patrick Air Force Base, Florida

PARSONS ENGINEERING SCIENCE, INC.
 Denver, Colorado

3.3 SITE GEOLOGY AND HYDROGEOLOGY

Characterization of the vadose zone and shallow aquifer system at Site ST-29 was the objective of a previous site investigation. ESE (1991) installed eight soil boreholes and six monitoring wells in the immediate vicinity of the BX Service Station.

3.3.1 Lithology and Stratigraphic Relationships

Logs for boreholes and wells installed by ESE (1991) indicate that near-surface deposits consist of Holocene- and Pleistocene-age, fine- to coarse-grained marine sand that is poorly to moderately sorted and contains up to 40 percent shell fragments. These sand deposits extend to a depth of approximately 25 feet and contain interspersed organic matter. In some locations, the sand is stained dark gray and black from petroleum constituents. Soil borehole samples exhibited organic vapor readings ranging from background levels to greater than 200 ppmv.

The Anastasia Formation is discontinuous in this area and apparently was not encountered in boreholes installed by ESE at Site ST-29. A unit of the Caloosahatchee Marl formation was reportedly encountered at a depth of 25 feet below ground surface (bgs) in PPOL2-6 (ESE, 1991). Below 25 feet bgs, the soil was blue-gray, dense, moderately well-sorted fine- to medium-grained silty sand with 5 to 65 percent shell fragments. Organic matter was dispersed throughout this unit, occasionally occurring in thin beds approximately 0.25-foot thick.

Below 51 feet in PPOL2-6, the Caloosahatchee Formation is a clay marl. As observed in this well, the unit is a blue-gray to dark-green clay marl layer with shell and limestone fragments. No soil discoloration or organic vapor readings above background were noted in these soils. The clay marl encountered in PPOL2-6 was observed from 51 feet bgs to at least 57 feet bgs. The clay marl reportedly correlates with a discontinuous, semiconfining clayey sand and silt unit within the Caloosahatchee Marl. The clayey unit has been encountered at Patrick AFB during other investigations, but the extent and thickness of the deposit has not been fully documented (ESE, 1991).

CPT data collected by ARA and Parsons ES in March 1994 indicate that deposits from the ground surface to approximately 20 feet bgs generally consist of sand and gravelly sand. Field observations by Parsons ES personnel indicate that the upper 2 to 4 feet of soil is fill, underlain in some locations by a thin layer of decayed organic material. The fill is reportedly material dredged from the Banana River and graded to level the Base area and raise it above marshy or wetland

areas. Based on the CPT logs, the fill generally appears as gravelly sand or poorly sorted sand. Native sand units are generally well sorted with some intervals of poorly sorted sand. Given the available information on the local geology, it is likely that the much of the soil indicated by CPT to be gravelly sand is actually sand with shell material. In some locations, visual inspection of soil samples collected near the water table indicated the presence of a thin, organic-rich layer. This layer is not distinguishable using the CPT logs, and is likely soil or vegetation that was buried when the site was filled.

A body of silty clay and/or clayey silt was detected below 11 to 13 feet bgs in the vicinity of CPT locations CPT-05, CPT-06, CPT-08, CPT-09, and CPT-13. The exact geometry of the silt and clay unit is uncertain, but it appears to be of limited horizontal extent, pinching out north of CPT-13 and possibly pinching out south of CPT-08. Thickness of this unit appears to range up to at least 8 feet. The presence of these fine-grained deposits may indicate that the Anastasia Formation is present, but it is more likely that they represent a small, localized lens of fine material. Figure 3.2 shows the locations of cross-sections constructed using the geologic information gathered through CPT. Figure 3.3 shows cross-section A - A', oriented parallel to the direction of groundwater flow. Cross-section B - B', which is oriented perpendicular to groundwater flow, is presented as Figure 3.4.

3.3.2 Groundwater Hydraulics

3.3.2.1 Flow Direction and Gradient

Shallow groundwater at Site ST-29 is present at depths of 4 to 5 feet bgs. Based on available hydrogeologic data, this shallow aquifer is unconfined. Historic groundwater elevation data for existing wells indicate that flow in the Site ST-29 area is generally to the west (ESE, 1991). Groundwater elevation data collected in March 1994 is presented in Table 3.1. Figure 3.5 shows the configuration of the shallow groundwater surface in the vicinity of Site ST-29 in March 1994. As indicated on Figure 3.5, the overall groundwater flow direction is to the west, toward the Banana River. The available data suggest that the flow in the site vicinity converges from the north and south in a relative low area from which flow is then to the west.

Water level data from CPT-25 indicate that a groundwater divide is present in the vicinity of Building 736. The groundwater elevation measured at CPT-25 (south and east of Building 736) was 0.78 foot above msl, while the measurement, at CPT-22 (just south of Building 737), was

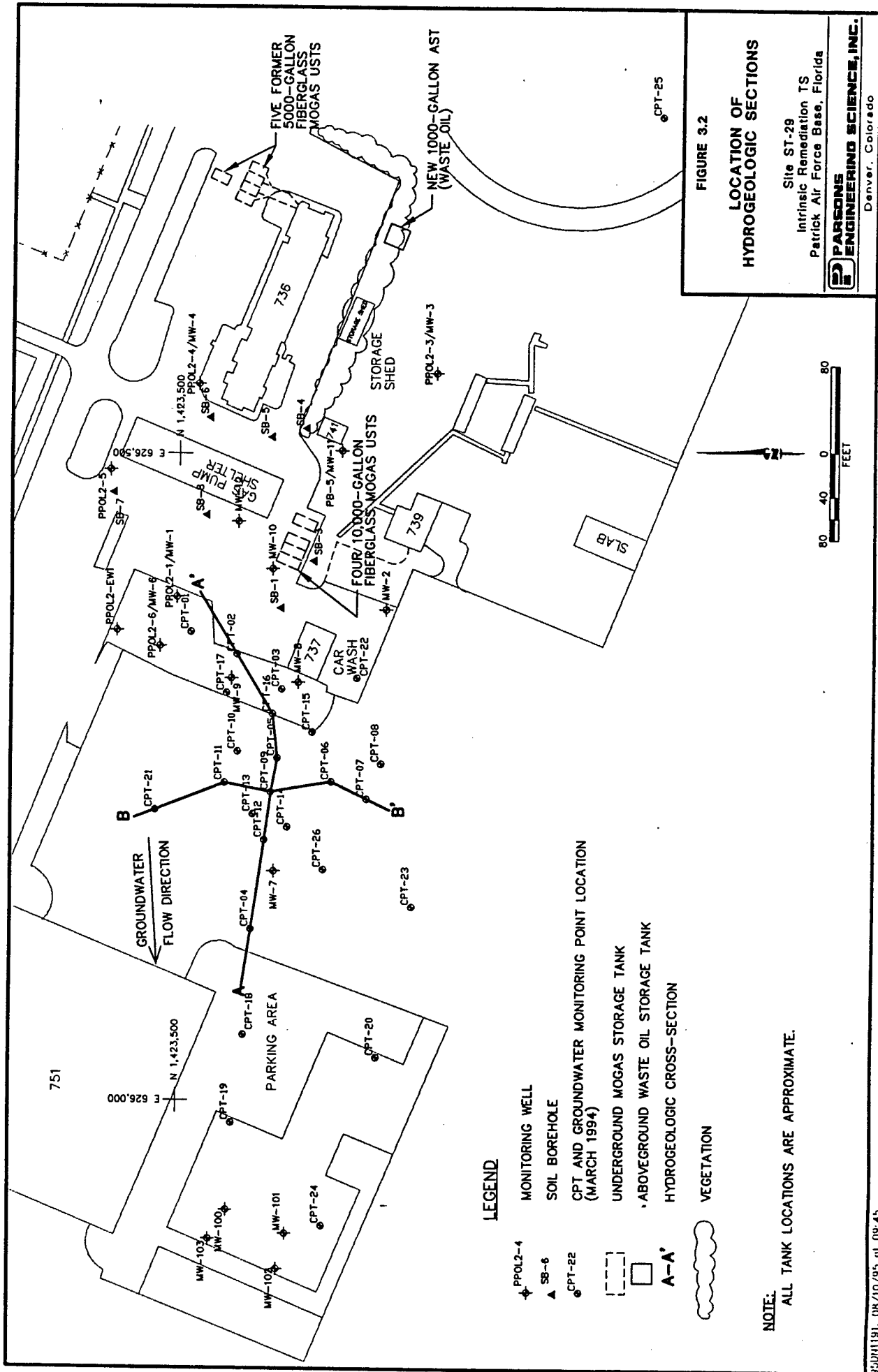
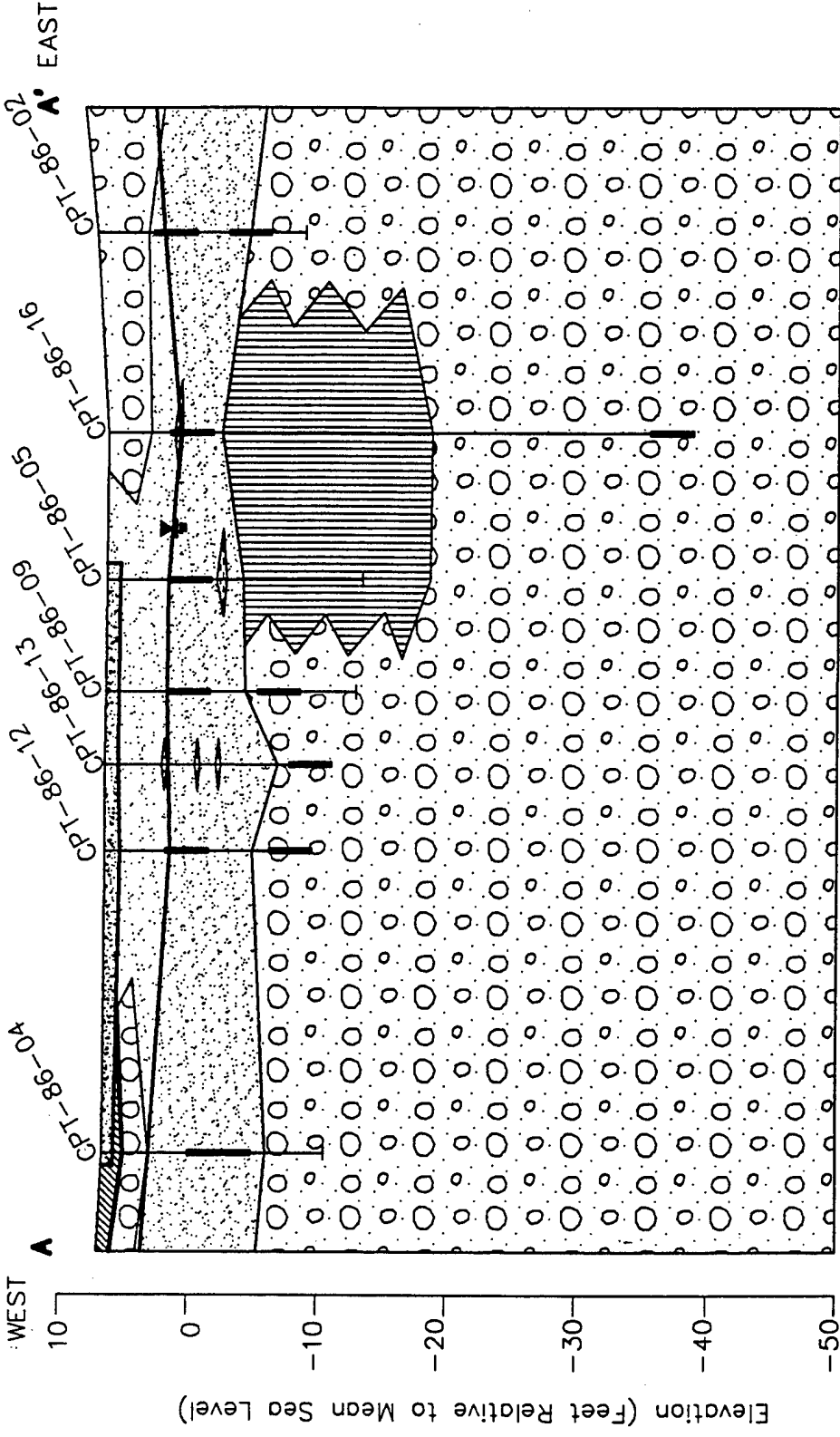

FIGURE 3.2
LOCATION OF
HYDROGEOLOGIC SECTIONS
 Site ST-29
 Intrinsic Remediation TS
 Patrick Air Force Base, Florida
PARSONS
ENGINEERING SCIENCE, INC.
 Denver, Colorado

LEGEND

- ◆ PPOL2-4 MONITORING WELL
- ▲ SB-6 SOIL BOREHOLE
- CPT-22 CPT AND GROUNDWATER MONITORING POINT LOCATION (MARCH 1994)
- ▭ UNDERGROUND MOGAS STORAGE TANK
- ▭ ABOVEGROUND WASTE OIL STORAGE TANK
- A-A' HYDROGEOLOGIC CROSS-SECTION
- ⊖ VEGETATION

NOTE:
 ALL TANK LOCATIONS ARE APPROXIMATE.



3X VERTICAL EXAGGERATION

- LEGEND**
- GRAVELLY SAND
 - SAND
 - CLAY
 - SILT
 - CONCRETE

CPT-86-09

- Well Point Identification
- Well Point
- Well Point Screen
- Bottom of Well Point
- Location of Water Table

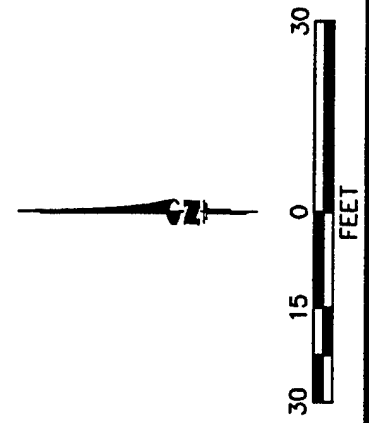

FIGURE 3.3

**HYDROGEOLOGIC
CROSS-SECTION 'A-A'**

Site ST-29
Intrinsic Remediation TS
Patrick Air Force Base, Florida

**PARSONS
ENGINEERING SCIENCE, INC.**
Denver, Colorado

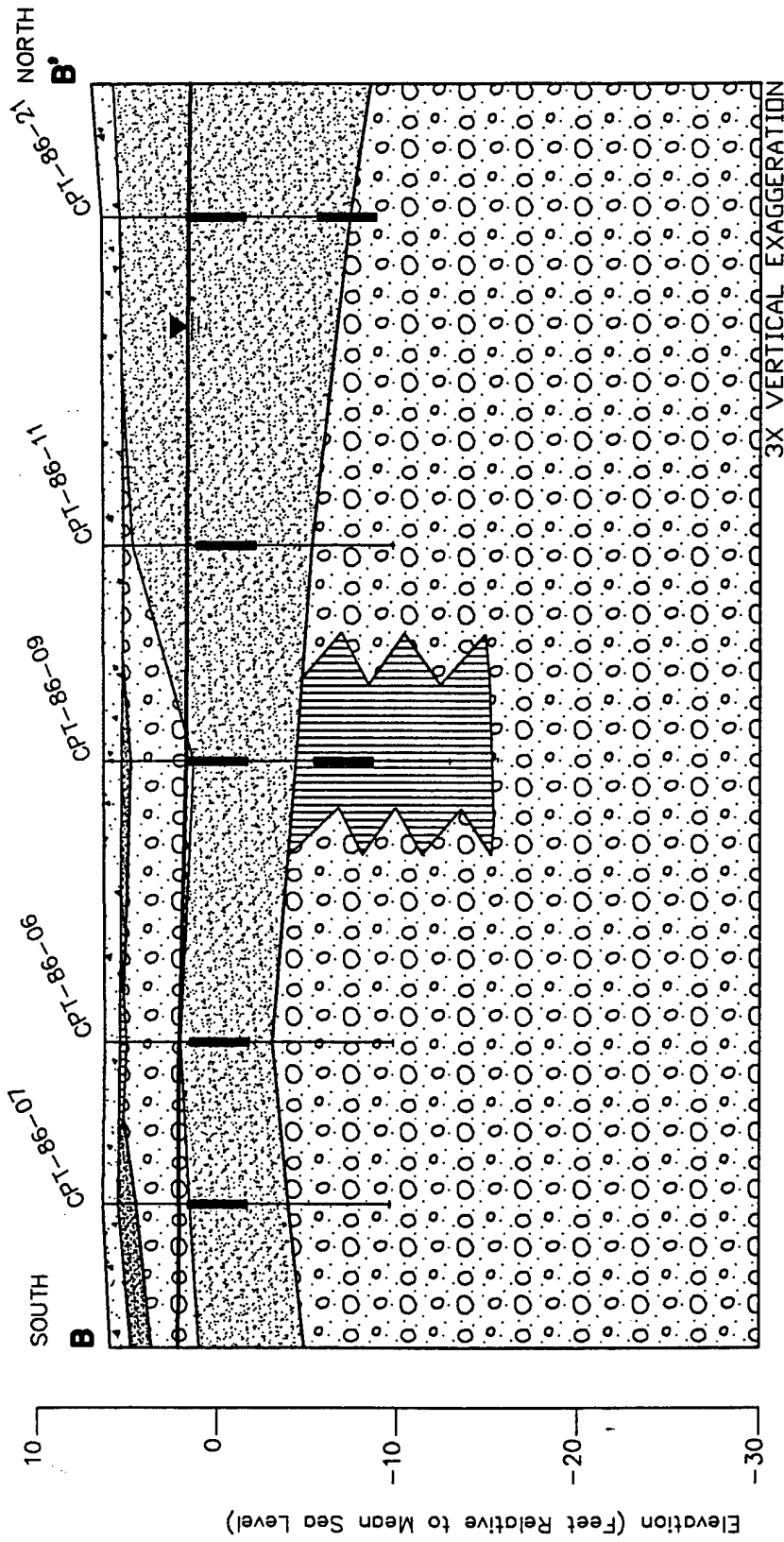

FIGURE 3.4

**HYDROGEOLOGIC
CROSS-SECTION B-B'**

Site ST-29
Intrinsic Remediation TS
Patrick Air Force Base, Florida



Denver, Colorado

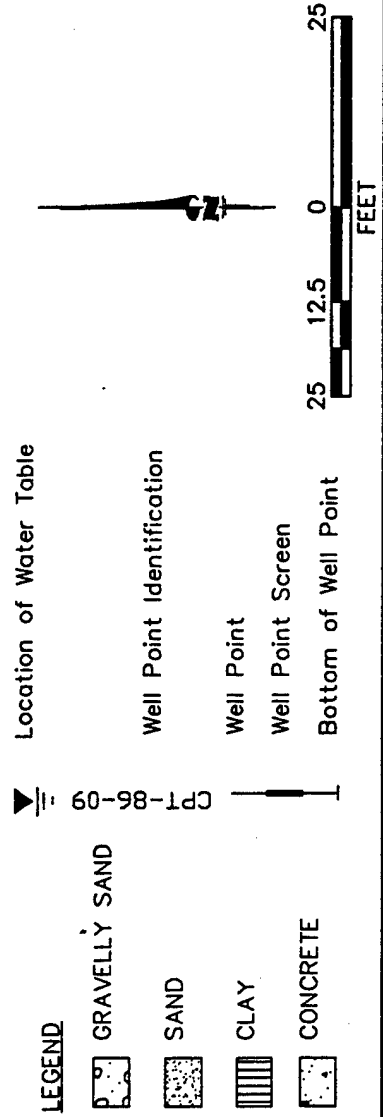

TABLE 3.1

WATER LEVEL ELEVATION DATA
 SITE ST-29 INTRINSIC REMEDIATION TS
 PATRICK AFB, FLORIDA

Sample Location	Sample Date	Easting	Northing	Datum ^{a/} Elevation (ft msl)	Ground Elevation (ft msl)	Total Depth (ft btoc)	Depth to Water (ft btoc)	Water Elevation (ft msl)
CPT-02S	3/27/94	1423346	626455	6.61	7.07	7.58	4.93	1.68
CPT-03D	3/27/94	1423319	626420	6.23	6.55	19.13	4.59	1.64
CPT-03S	3/27/94	1423319	626420	6.26	6.55	7.90	4.57	1.69
CPT-04D	3/27/94	1423133	626443	6.01	6.57	11.36	4.46	1.55
CPT-04S	3/27/94	1423133	626443	5.99	6.57	NR ^{b/}	4.46	1.53
CPT-09S	3/27/94	1423240	626428	6.13	6.35	7.76	4.35	1.78 ^{c/}
CPT-12S	3/27/94	1423203	626433	5.90	6.43	7.56	4.40	1.50
CPT-18S	3/27/94	1423051	626448	6.11	6.58	7.40	4.69	1.42
CPT-22D	3/27/94	1423328	626362	6.32	6.75	9.77	4.49	1.83
CPT-22S	3/27/94	1423328	626362	6.35	6.75	7.50	4.50	1.85
CPT-23D	3/27/94	1423151	626319	5.84	6.57	12.70	4.20	1.64
CPT-23S	3/27/94	1423151	626319	5.94	6.57	6.31	4.30	1.64
CPT-24D	3/27/94	1422903	626386	5.44	5.89	12.49	4.46	0.98
CPT-24S	3/27/94	1422903	626386	5.49	5.89	6.06	4.52	0.97
CPT-25D	3/27/94	1423761	626129	6.49	6.60	12.72	5.72	0.77
CPT-25S	3/27/94	1423761	626129	6.43	6.60	6.31	5.66	0.77
CPT-26D	3/27/94	1423180	626387	5.79	6.47	12.73	4.13	1.66
CPT-26S	3/27/94	1423180	626387	5.89	6.47	6.29	4.25	1.64 ^{c/}
PB5	3/23/94	NA ^{d/}	NA	10.86	7.39	15.45	8.75	2.11
PPOL2-1	3/25/94	1423390	626502	7.47	6.92	NA	5.33	2.14
PPOL2-5	3/25/94	NA	NA	7.48	NA	12.51	5.36	2.12
PPOL2-6	3/25/94	1423352	626515	6.64	6.39	NA	4.93	1.71

^{a/} Datum is top of well casing.

^{b/} NR = No Reading.

^{c/} Data are suspect.

^{d/} NA = Not available.

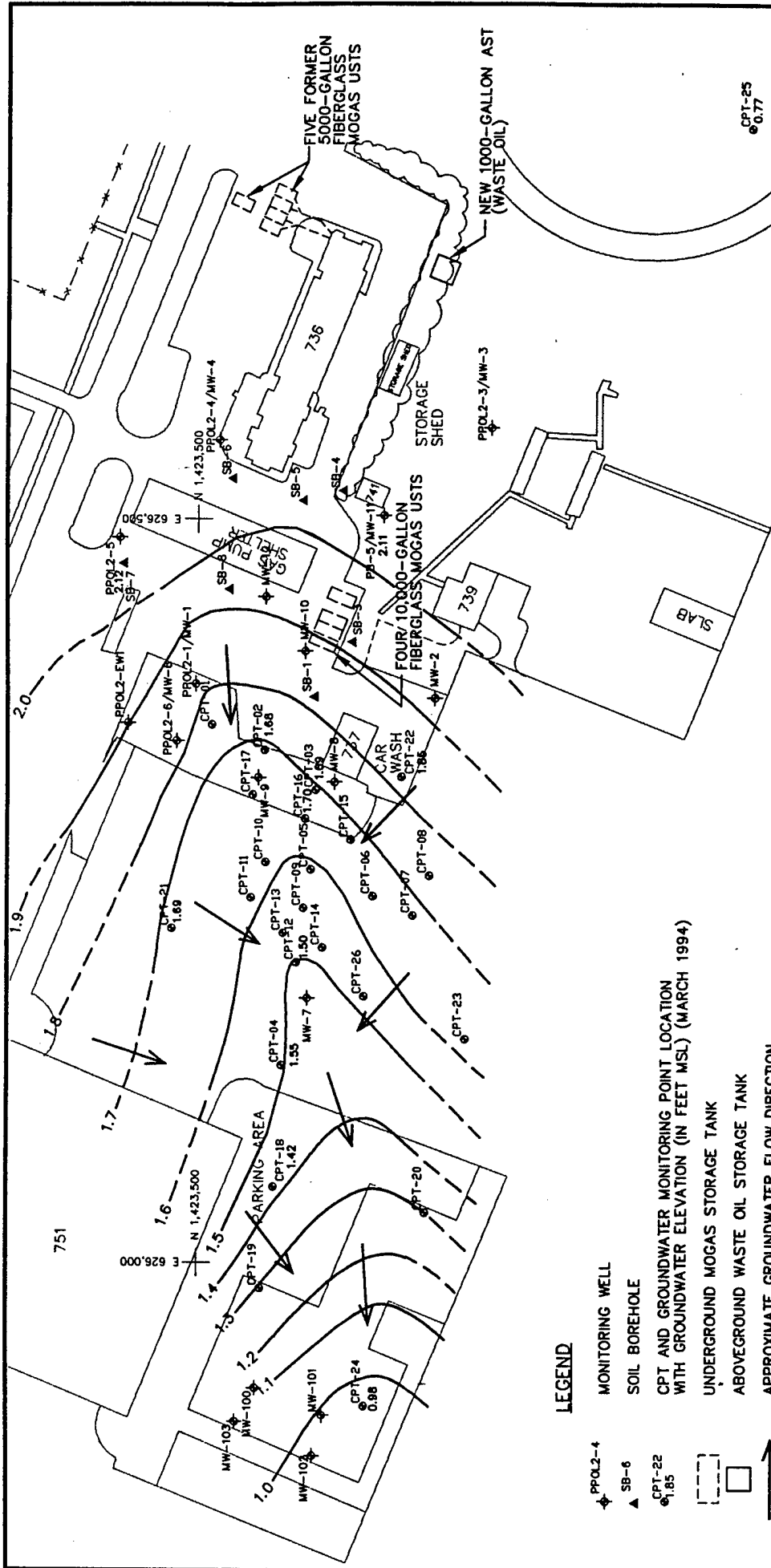

FIGURE 3.5
GROUNDWATER ELEVATIONS (MARCH 1994)
 Site ST-29
 Intrinsic Remediation TS
 Patrick Air Force Base, Florida

PARSONS ENGINEERING SCIENCE, INC.
 Denver, Colorado

LEGEND

- ◆ PPOL-4 MONITORING WELL
- ▲ SB-6 SOIL BOREHOLE
- CPT-22 WITH GROUNDWATER ELEVATION (IN FEET MSL) (MARCH 1994)
- UNDERGROUND MOGAS STORAGE TANK
- ▭ ABOVEGROUND WASTE OIL STORAGE TANK
- ➔ APPROXIMATE GROUNDWATER FLOW DIRECTION
- 1.6 — LINE OF EQUAL GROUNDWATER ELEVATION (IN FEET MSL) (DASHED WHERE INFERRED)
- ☁ VEGETATION
- CONTOUR INTERVAL = 0.1 FOOT

NOTE:
 ALL TANK LOCATIONS ARE APPROXIMATE.

1.85 feet above msl, suggesting a southeasterly or easterly flow direction east of Building 736. The presence of a divide in this area is also supported by previous data from wells PPOL2-1 through PPOL2-6, which indicate groundwater flow in the area of the service station is to the west. Additional water level elevation data collected in 1994 (but not concurrent with the data from the CPT points) also confirms that the divide exists, likely to the east of wells PPOL2-4 and PPOL2-3 (CH2M Hill, 1994).

Previous data indicated that the horizontal hydraulic gradient at the site ranges from 0.00096 to 0.003 foot per foot (ft/ft) (ESE, 1991; O'Brien and Gere Engineers, Inc., 1992). Water level measurements made by Parsons ES in March 1994 also indicate that the local hydraulic gradient is approximately 0.002 ft/ft. Given the distance to the Banana River (2,400 feet) and the water level elevations observed at the site (1 to 2 feet above msl), it is likely that the gradient diminishes to the west. If the observed gradient (0.002) extended all the way to the Banana River, the water table would be 2 to 3 feet below msl at the Banana River.

Vertical hydraulic gradients measured in monitoring point nests range from 0.000 ft/ft (i.e., no vertical gradient) at CPT-23 to 0.003 ft/ft (downward) at CPT-03 and CPT-22. There is no evidence of upward gradients within the shallow aquifer at this site, which is consistent with the proximity of the area to a groundwater divide. In typical groundwater flow systems, the vertical component of flow is downward in the vicinity of a divergent groundwater divide. Vertical gradients typically decrease or flatten out away from the divergent divide, eventually turning upward in the vicinity of groundwater discharge areas or convergent groundwater divides. It appears that the local flow system exhibits a pattern similar to this description. Downward vertical gradients were observed at CPT-03 and CPT-22, which are closer to the divide than most other nests. Further downgradient from the divide, such as at CPT-23, the vertical gradient diminishes. The apparent discharge area for the local western groundwater flow component is the Banana River, and it likely that vertical gradients nearer the river are directed upward. On the eastern side of the divide, groundwater flow discharges to the Atlantic Ocean.

3.3.2.2 Hydraulic Conductivity

No previous slug test data are available for the site. ESE (1991) estimated average hydraulic conductivity (K) in the ST-29 area to be 0.26 foot per minute (ft/min), based on data gathered in other areas of Patrick AFB and the assumption that the soil lithologies throughout Patrick AFB are relatively similar (ESE, 1991). Rising head slug tests were conducted by Parsons ES in March 1994 according to methods mentioned in Section 2. Results of these tests suggest that the

hydraulic conductivity of the shallow portion of the aquifer is in the range of 0.023 to 0.089 ft/min, with an average K of approximately 0.052 ft/min, or 0.026 centimeter per second (cm/sec). Slug test results are summarized in Table 3.2.

TABLE 3.2
SLUG TEST RESULTS
SITE ST-29 INTRINSIC REMEDIATION TS
PATRICK AFB, FLORIDA

WELL	TEST	HYDRAULIC CONDUCTIVITY (feet/minute)	HYDRAULIC CONDUCTIVITY (cm/sec)
PPOL2-1	Rising Head #2	0.023	0.012
PPOL2-4	Rising Head #1	0.064	0.032
PPOL2-4	Rising Head #2	0.089	0.045
PPOL2-5	Rising Head #1	0.031	0.016
PPOL2-5	Rising Head #2	0.025	0.013
PPOL2-6	Rising Head #1	0.096	0.049
	AVERAGE*	0.052	0.026

* Average of wells PPOL2-1, PPOL2-4, and PPOL2-5.
 Well PPOL2-6 completed near base of shallow aquifer.

3.3.2.3 Effective Porosity (n_e)

Because of the difficulty involved in accurately determining effective porosity, accepted literature values for the type of soil comprising the shallow saturated zone were used. Freeze and Cherry (1979) give a range of effective porosity for sand and/or gravel of 0.25 to 0.50. The effective porosity for sediments of the shallow saturated zone was initially assumed to be 0.35 for calculating the advective groundwater velocity.

3.3.2.4 Advective Groundwater Velocity (\bar{v})

The advective velocity of groundwater in the direction parallel to groundwater flow is given by:

$$\bar{v} = \frac{-K}{n_e} \frac{dH}{dL}$$

Where: \bar{v} = Average advective groundwater velocity (seepage velocity) [L/T]

K = Hydraulic conductivity [L/T]

dH/dL = Gradient [L/L]

n_e = Effective porosity.

Using this relationship in conjunction with site-specific gradient (0.002 ft/ft) and hydraulic conductivity (0.052 ft/min) data, the average advective groundwater velocity at the site can be calculated. Because effective porosity was not measured at the site, velocity calculations were performed for the assumed value of 0.35, as well as for 0.25 and 0.50, which define the limits of the range indicated by Freeze and Cherry (1979).

Using an effective porosity of 0.35, the average advective groundwater velocity is 0.43 foot per day (ft/day) or approximately 156 ft/year. Using effective porosity values of 0.25 and 0.50 yields velocities of 0.6 ft/day and 0.3 ft/day, respectively (220 ft/yr and 110 ft/yr, respectively).

3.3.2.5 Preferential Flow Paths

One preferential contaminant migration pathway was identified during the field work phase of this project. This pathway is a storm sewer located just west of the car wash area. This storm sewer runs northeast-southwest, 6 feet west of and roughly parallel to the western edge of the car wash building.

The influence of this corridor on contaminant migration has not been directly investigated. However, during field work conducted by Parsons ES and RSKERL personnel in March 1994, some visual observations were made. Access to the sewer was limited by heavy steel grates that could not readily be removed, so observations were made through the grates. It appeared that the storm sewer piping is made of concrete and did not contain moving water, although the base of the pipe may be deep enough to be near the water table. Puddles of standing water were present in the piping, but no petroleum sheen or odor was observed.

Because of the relatively high hydraulic conductivity of the shallow saturated zone and the nature of storm sewer construction (concrete), it is unlikely that this drain has a significant impact on groundwater flow at the site, unless preferential flow occurs through the backfill envelope surrounding the sewer. Further investigation of this occurrence was not possible at the time the observations were made. However, water level and BTEX data from CPT points installed near the sewer suggest that there is no groundwater flow or contaminant migration parallel to the sewer line. The BTEX plume described in Section 4 appears to pass beneath the storm sewer without redirection.

3.3.4 Groundwater Use

Groundwater from the unconsolidated surficial deposits at Patrick AFB is not extracted for any use. Water is obtained from the City of Cocoa Beach, with the City of Melbourne, Florida providing supplemental water if necessary. Patrick AFB maintains five standby water supply wells, primarily for fire suppression use. These wells are screened in Ocala Formation limestones that are part of the confined Floridan Aquifer.

3.4 CLIMATOLOGICAL CHARACTERISTICS

The climate of the barrier island is humid subtropical. Monthly mean high temperatures range from 69 degrees Fahrenheit (°F) in January to 87°F in July and August. Extreme high and low temperatures for the period from 1950 to 1980 were 99°F and 27°F, respectively.

Rainfall is unevenly distributed throughout the year, with the period from June through October having distinctly more precipitation than the rest of the year. A 30-year (1950 to 1980) mean of the annual precipitation recorded at Patrick AFB is 44.7 inches, and the mean annual evapotranspiration is 40.3 inches (ESE, 1991). Based on these data, an average of 4.4 inches of precipitation is available to infiltrate through surface soils and recharge groundwater on an annual basis.

SECTION 4

NATURE AND EXTENT OF CONTAMINATION AND SOIL AND GROUNDWATER GEOCHEMISTRY

4.1 SOURCE OF CONTAMINATION

The former 10,000-gallon MOGAS UST and the product lines that were discovered to be leaking in 1986 were apparently the sources of contamination at Site ST-29. It was estimated that 700 gallons of product was released between 1985, when the tanks were installed, and 1986, when the leaking UST was removed and the line was presumably repaired. Records describing activities to mitigate the leaks and remediate soil at that time were not available during preparation of this report. Data from previous investigations (ESE, 1991; ES, 1993) indicate that soil contamination is concentrated in the areas near and downgradient from the 10,000-gallon MOGAS USTs, north of the car wash (Building 737, Figure 3.5).

4.2 SOIL CHEMISTRY

4.2.1 Residual Contamination

Residual light nonaqueous-phase liquid (LNAPL) is defined as the LNAPL that is trapped in the aquifer by the processes of cohesion and capillarity, and therefore will not flow within the aquifer and will not flow from the aquifer matrix into a well under the influence of gravity. Mobile LNAPL (i.e., free product) is defined as the LNAPL that is free to flow in the aquifer and that will flow from the aquifer matrix into a well under the influence of gravity. Mobile LNAPL has not been detected in monitoring wells or monitoring points at Site ST-29. Observations made during installation of a bioventing unit northeast of the car wash suggest that significant contamination was present, with the soil reportedly saturated with fuel hydrocarbons (ES, 1993). The following sections describe the residual LNAPL contamination found at Site ST-29.

4.2.1.1 Soil BTEX Contamination

Residual BTEX contamination resulting from vertical and lateral migration of mobile LNAPL and dissolved hydrocarbons is found over a wide area at Site ST-29. Table 4.1 contains soil BTEX data. Figure 4.1 shows the extent of contaminated soil indicated by LIF data and laboratory analytical results. Soil BTEX contamination appears to extend at least to CPT-09, approximately 220 feet downgradient from the source area. The zone of contaminated soil is approximately 90 feet wide at its widest point.

LIF data collected during CPT activities suggest that hydrocarbon contamination is present in the vicinity of points CPT-02, CPT-03, CPT-09, and possibly CPT-10. LIF profiles (Gildea *et al.*, 1994) suggest the presence of hydrocarbons at or slightly above the water table in these locations. It appears that the hydrocarbons detected by LIF are residual LNAPL and not mobile LNAPL, because monitoring points installed at the water table in the same locations did not contain free product. These detections may represent dissolved contamination carried into the unsaturated zone during a period of elevated groundwater levels or the remains of a smear zone created as a thin layer of free product migrated laterally with groundwater flow and was introduced to the soil as the water table fluctuated.

The highest observed concentration of residual total BTEX is 1,236.07 milligrams per kilogram (mg/kg) in a soil sample taken from 6 feet bgs at CPT-02, which is about 120 feet west-northwest of the suspected source of hydrocarbon contamination (Figure 4.1). A total BTEX concentration of 974.83 mg/kg was detected at 5.5 feet bgs at CPT-03, which is directly downgradient from the source area. At CPT-02 and CPT-03, the highest concentrations were in the vicinity of the water table (e.g., 5.5 to 6 feet bgs). In both locations, concentrations are generally an order of magnitude lower within 1 foot above and below the highest concentrations, and another order of magnitude lower 2 feet above and below the interval with the greatest contamination. Samples collected from CPT-05, CPT-09, CPT-13, and CPT-15 also contained BTEX compounds, but at total concentrations below 0.1 mg/kg (Table 4.1).

Benzene was detected in samples from CPT-02 and CPT-03 in concentrations ranging from 0.164 to 6.99 mg/kg. Benzene also was detected in one sample from CPT-16 at a concentration of 0.00752 mg/kg. These locations are downgradient from the main source area; in the source area, benzene was not detected in soil or soil gas samples collected

TABLE 4.1

FUEL HYDROCARBON COMPOUNDS DETECTED IN SOIL
SITE ST-29 INTRINSIC REMEDIATION TS
PATRICK AFB, FLORIDA

Sample Location	Depth (ft bgs)	Benzene (mg/kg)	Toluene (mg/kg)	Ethylbenzene (mg/kg)	p-Xylene (mg/kg)	m-Xylene (mg/kg)	o-Xylene (mg/kg)	Total Xylenes (mg/kg)	Total BTEX (mg/kg)	1,3,5-TMIB (mg/kg)	1,2,4-TMIB (mg/kg)	1,2,3-TMIB (mg/kg)	TPH ^w (mg/kg)
CPT-02-A17	4	BLQ ^b	BLQ	0.0345	0.0249	0.054	0.0296	0.1085	0.143	0.018	0.0514	0.017	ND ^c
CPT-02-A18	5	0.197	0.0605	0.514	1.44	0.976	0.703	3.119	3.8905	3.1	3.28	2.65	140
CPT-02-A19	6	6.99	8.08	191	257	542	231	1030	1236.07	274	786	180	17100
CPT-02-A20	6.45	0.68	0.345	16.1	20.3	45.9	17.9	84.1	101.225	26	77.4	17.5	1660
CPT-02-A21	7	0.339	0.106	2.26	2.91	6.77	2.74	12.42	15.125	3.75	11.7	2.59	289
CPT-03-A22	3	0.164	0.0142	0.21	0.253	0.323	0.243	1.019	1.4072	0.319	0.844	0.227	20.9
CPT-03-A23	4.5	ND	BLQ	0.00838	0.0102	0.0209	0.0107	0.0418	0.05018	0.0155	0.0461	0.013	0.2
CPT-03-A24	5.5	BLQ	0.462	BLQ	39.8	45.7	85.8	171.3	171.762	253	332	123	11700
CPT-03-A25	6.5	2.33	29.5	120	186	428	209	823	974.83	181	675	124	9300
CPT-03-A26	7	0.366	0.532	2.02	3.48	7.58	4.4	15.46	18.378	3.97	12.7	2.87	287
CPT-5-A1	3.5	BLQ	BLQ	BLQ	BLQ	BLQ	BLQ	BLQ	BLQ	BLQ	0.00746	BLQ	ND
CPT-5-A2	4.5	BLQ	BLQ	BLQ	BLQ	BLQ	BLQ	BLQ	BLQ	BLQ	0.0117	BLQ	ND
CPT-5-A3	5	BLQ	BLQ	BLQ	0.00725	BLQ	BLQ	0.00725	0.00725	BLQ	0.00879	BLQ	ND
CPT-5-A4	5.5	BLQ	BLQ	BLQ	BLQ	BLQ	BLQ	BLQ	BLQ	BLQ	0.0149	BLQ	ND
CPT-9-A4	2.5	BLQ	BLQ	ND	BLQ	BLQ	BLQ	BLQ	BLQ	BLQ	ND	ND	2
CPT-9-A5	4.5	BLQ	BLQ	BLQ	BLQ	BLQ	ND	BLQ	BLQ	BLQ	BLQ	BLQ	47.1
CPT-9-A6	5	BLQ	0.034	BLQ	0.0311	0.0229	0.0109	0.0649	0.0989	0.0121	BLQ	0.00976	2740
CPT-9-A7	6	BLQ	BLQ	BLQ	BLQ	BLQ	BLQ	BLQ	BLQ	BLQ	0.00818	BLQ	15.2
CPT-13	5.5	BLQ	BLQ	BLQ	BLQ	BLQ	BLQ	BLQ	BLQ	BLQ	BLQ	BLQ	ND
CPT-15-A8	3	BLQ	BLQ	ND	BLQ	BLQ	BLQ	BLQ	BLQ	BLQ	0.016	BLQ	ND
CPT-15-A9	4	BLQ	BLQ	ND	BLQ	BLQ	BLQ	BLQ	BLQ	BLQ	0.0128	BLQ	0.01
CPT-15-A10	5	BLQ	0.012	0.00978	BLQ	BLQ	0.0226	0.0226	0.04438	BLQ	0.0114	BLQ	526
CPT-15-A11	5.5	ND	ND	BLQ	BLQ	BLQ	BLQ	BLQ	BLQ	BLQ	0.0179	BLQ	ND
CPT-16-A1	4.5	0.00752	0.00761	BLQ	BLQ	BLQ	BLQ	BLQ	0.01513	BLQ	0.00658	BLQ	0.04
CPT-16-A2	6	ND	BLQ	ND	BLQ	BLQ	BLQ	BLQ	BLQ	BLQ	0.0104	BLQ	ND
CPT-17-A12	2	ND	BLQ	BLQ	BLQ	BLQ	BLQ	BLQ	BLQ	BLQ	0.0127	BLQ	ND
CPT-17-A13	3	ND	BLQ	ND	BLQ	BLQ	BLQ	BLQ	BLQ	BLQ	0.0248	BLQ	ND
CPT-17-A14	4	ND	BLQ	BLQ	BLQ	0.00779	BLQ	0.00779	0.00779	BLQ	0.0176	BLQ	ND
CPT-17-A15	5	ND	BLQ	ND	BLQ	BLQ	BLQ	BLQ	BLQ	BLQ	0.0172	BLQ	ND

^w TPH = Total petroleum hydrocarbons (quantified with a JP-4 standard).

^b BLQ = Below limit of quantitation, or <0.02 mg/kg.

^c ND = Not detected

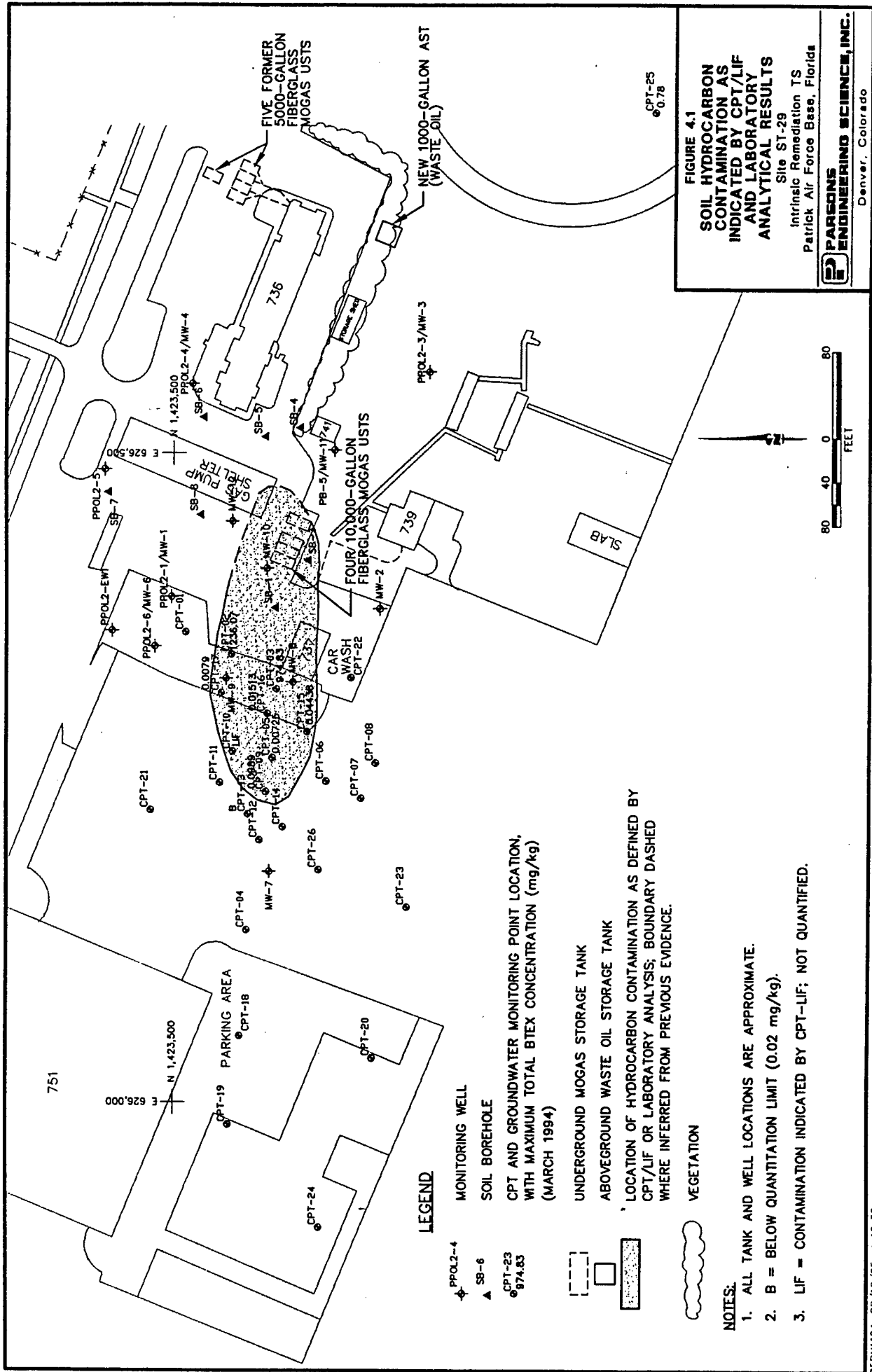

FIGURE 4.1
SOIL HYDROCARBON
CONTAMINATION AS
INDICATED BY CPT/LIF
AND LABORATORY
ANALYTICAL RESULTS
 Site ST-29
 Intrinsic Remediation TS
 Patrick Air Force Base, Florida

PARSONS
ENGINEERING SCIENCE, INC.
 Denver, Colorado

LEGEND

- PPOL2-4 MONITORING WELL
- SB-6 SOIL BOREHOLE
- CPT-23 974.83 CPT AND GROUNDWATER MONITORING POINT LOCATION, WITH MAXIMUM TOTAL BIEX CONCENTRATION (mg/kg) (MARCH 1994)
- UNDERGROUND MOGAS STORAGE TANK
- ABOVEGROUND WASTE OIL STORAGE TANK
- LOCATION OF HYDROCARBON CONTAMINATION AS DEFINED BY CPT/LIF OR LABORATORY ANALYSIS; BOUNDARY DASHED WHERE INFERRED FROM PREVIOUS EVIDENCE.
- VEGETATION

NOTES:

1. ALL TANK AND WELL LOCATIONS ARE APPROXIMATE.
2. B = BELOW QUANTITATION LIMIT (0.02 mg/kg).
3. LIF = CONTAMINATION INDICATED BY CPT-LIF; NOT QUANTIFIED.

during installation and evaluation of the bioventing system. Total BTEX concentrations of 2,816 mg/kg were detected in soils during installation of the horizontal bioventing test well (ES, 1993 and 1994a).

4.2.1.2 Soil TPH Contamination

Total petroleum hydrocarbons (TPH) were detected in nearly all of the locations where BTEX compounds were detected. Table 4.1 presents the soil TPH data. All locations where TPH were detected are located within the shaded area shown on Figure 4.1, although TPH concentrations are not indicated on this figure. The USEPA laboratory quantified TPH concentrations by comparison to a JP-4 standard, while the source of contamination is MOGAS, which is composed of larger fractions of lighter hydrocarbons (e.g., the BTEX compounds). While there is a possibility that this could bias the TPH concentrations below those measured against a gasoline-based standard, it does not appear to present a problem at this site. In most locations where both TPH and BTEX compounds were detected, TPH concentrations are at least 10 times the BTEX concentrations. In addition, it is likely that the residual product in the soil is weathered, and that the fraction of BTEX has diminished such that the remaining fraction is largely comprised of heavier gasoline hydrocarbons, such as those that comprise a large fraction of JP-4. In addition, TPH data were collected only to provide additional information on the nature and extent of hydrocarbon contamination.

4.2.2 Total Organic Carbon

TOC concentrations are used to estimate the amount of organic matter sorbed on soil particles or trapped in the interstitial passages of a soil matrix. The TOC concentration in the saturated zone is an important parameter used to estimate the amount of contaminant that could potentially be sorbed to the aquifer matrix. Sorption results in retardation of the contaminant plume relative to the average advective groundwater velocity. Measurements of TOC were taken from core samples obtained from several CPT locations. TOC in the soil at this site ranges from 0.016 to 1.86 percent (Table 4.2). Some of the highest values are from samples that also contained significant concentrations of BTEX compounds. However, TOC concentrations are high in some samples because of organic matter.

TABLE 4.2
SOIL TOTAL ORGANIC CARBON RESULTS
SITE ST-29 INTRINSIC REMEDIATION TS
PATRICK AFB, FLORIDA

Sample Location	Sample Number	Depth (feet bgs)	% Total Organic Carbon (mean \pm SD) ^{a/}
CPT-02	86-02-A17	4.0	0.016 \pm 0.002
CPT-02	86-02-A18	5.0	0.707 \pm 0.022
CPT-02	86-02-A19	6.0	0.166 \pm 0.022
CPT-02	86-02-A20	6.5	0.089 \pm 0.015
CPT-02	86-02-A21	7.0	0.158 \pm 0.034
CPT-03	86-03-A22	3.0	0.189 \pm 0.068
CPT-03	86-03-A23	4.5	0.087 \pm 0.008
CPT-03	86-03-A24	5.5	0.373 \pm 0.030
CPT-03	86-03-A25	6.5	0.111 \pm 0.020
CPT-03	86-03-A26	7.0	0.182 \pm 0.040
CPT-05	86-05-A1	3.5	0.028 \pm 0.001
CPT-05	86-05-A2	4.5	0.065 \pm 0.002
CPT-05	86-05-A3	5.0	0.334 \pm 0.003
CPT-05	86-05-A4	5.5	1.260 \pm 0.220
CPT-09	86-09-A4	2.5	0.036 \pm 0.003
CPT-09	86-09-A5	4.5	0.042 \pm 0.006
CPT-09	86-09-A6	5.0	0.307 \pm 0.015
CPT-09	86-09-A7	6.0	1.860 \pm 0.083
CPT-13	86-13-SS1-A16	5.5	1.050 \pm 0.077
CPT-15	86-15-A8	3.0	0.031 \pm 0.001
CPT-15	86-15-A9	4.0	0.053 \pm 0.003
CPT-15	86-15-A10	5.0	1.130 \pm 0.030
CPT-15	86-15-A11	5.5	0.558 \pm 0.044
CPT-16	86-16-A1	4.5	0.580 \pm 0.029
CPT-16	86-16-A2	6.0	0.441 \pm 0.010
CPT-17	86-17-A12	2.0	0.026 \pm 0.001
CPT-17	86-17-A13	3.0	0.034 \pm 0.001
CPT-17	86-17-A14	4.0	0.294 \pm 0.009
CPT-17	86-17-A15	5.0	0.379 \pm 0.016

a/ SD = Standard Deviation.

4.3 GROUNDWATER CHEMISTRY

4.3.1 Dissolved Contamination

Laboratory analytical results for groundwater samples collected during previous site investigations indicated the presence of fuel-hydrocarbon contamination in the shallow saturated zone in the vicinity of Site ST-29. Groundwater samples collected in March 1994 by Parsons ES and RSKERL personnel, by RSKERL personnel in March 1995, and by CH2M Hill in May 1995, confirmed these results. Table 4.3 summarizes groundwater contaminant data for March 1994. Table 4.4 summarizes groundwater contaminant data for March and May 1995.

During March 1994 sampling activities, Parsons ES and RSKERL personnel noted that the groundwater in the site vicinity often displayed unusual odors or characteristics. For example, water from existing wells MW-100 through MW-103, locations downgradient from the site near Building 751, appeared sudsy, as if soap or a surfactant were present. In addition, water from locations nearer the service station (e.g., CPT-05) had an odor similar to sulfur.

Figure 4.2 is an isopleth map that shows the distribution of total BTEX dissolved in groundwater in March 1994. Isopleths are drawn based on the maximum concentration detected at any of the sample depths at each location. Figure 4.3 is a vertical profile through the plume, showing the vertical distribution of contamination in March 1994. Figure 4.4 is an isopleth map that shows the distribution of total BTEX dissolved in groundwater in March and May 1995. Isopleths are drawn based on the maximum concentration detected at each location.

4.3.2 Documented Loss of Contaminants at the Field Scale

As noted in Section 1, the documented loss of contaminants at the field scale is the first of three lines of evidence that can be used to document the occurrence of intrinsic remediation. The data presented below provide strong evidence of the loss of contaminant mass at Site ST-29.

Dissolved BTEX contamination is migrating to the west in the direction of groundwater flow. As defined by the 5-microgram-per-liter ($\mu\text{g/L}$) total BTEX isopleth,

TABLE 4.3

FUEL HYDROCARBON COMPOUNDS DETECTED IN GROUNDWATER, MARCH 1994
 SITE ST-29 INTRINSIC REMEDIATION TS
 PATRICK AFB, FLORIDA

Sample Location	Sample Number	Sample Date	Benzene (µg/L)	Toluene (µg/L)	Ethylbenzene (µg/L)	p-Xylene (µg/L)	m-Xylene (µg/L)	o-Xylene (µg/L)	Total Xylenes (µg/L)	Total BTEX (µg/L)	1,3,5-TMB (µg/L)	1,2,4-TMB (µg/L)	1,2,3-TMB (µg/L)
CPT-01	CPT-86-001	3-23-94	BLQ ^v	2.42	BLQ	BLQ	BLQ	BLQ	BLQ	2.42	BLQ	BLQ	BLQ
CPT-02S	CPT-86-002S	3-23-94	375	18.9	165	166	353	119	638	1196.9	71.2	NA ^v	86.3
CPT-02D	CPT-86-002D	3-23-94	1.5	1.7	1.1	1.4	2.6	1.4	5.4	9.7	BLQ	NA	1.3
CPT-03S	CPT-86-003S	3-23-94	724	737	823	1220	2410	1390	5020	7304	347	NA	403
CPT-03M	CPT-86-003M	3-23-94	207	15.6	40.5	42.2	24	7.5	73.7	336.8	2.8	NA	16
CPT-03D	CPT-86-003D	3-23-94	1.8	1.1	BLQ	BLQ	1.4	BLQ	1.4	4.3	BLQ	NA	BLQ
CPT-04S	CPT-86-004S	3-23-94	BLQ	6	BLQ	BLQ	BLQ	BLQ	BLQ	6	BLQ	BLQ	BLQ
CPT-04D	CPT-86-004D	3-25-94	BLQ	3.7	BLQ	BLQ	BLQ	BLQ	BLQ	3.7	BLQ	BLQ	BLQ
CPT-05S	CPT-86-005S	3-25-94	BLQ	1.2	BLQ	BLQ	BLQ	BLQ	BLQ	1.2	BLQ	NA	BLQ
CPT-06S	CPT-86-006S	3-25-94	BLQ	11.1	BLQ	1.3	2.3	BLQ	3.6	14.7	BLQ	NA	BLQ
CPT-07S	CPT-86-007S	3-25-94	BLQ	3.9	BLQ	BLQ	1	BLQ	1	4.9	BLQ	NA	BLQ
CPT-08S	CPT-86-008S	3-25-94	BLQ	2.8	BLQ	BLQ	BLQ	BLQ	BLQ	2.8	BLQ	BLQ	BLQ
CPT-09S	CPT-86-009S	3-25-94	2	4	BLQ	BLQ	BLQ	BLQ	BLQ	6	BLQ	BLQ	BLQ
CPT-09D	CPT-86-009D	3-25-94	427	14.1	2.9	11.7	12.1	9.7	33.5	477.5	BLQ	NA	9.4
CPT-10S	CPT-86-010S	3-25-94	BLQ	3.1	BLQ	BLQ	BLQ	BLQ	BLQ	3.1	BLQ	BLQ	BLQ
CPT-11S	CPT-86-011S	3-25-94	BLQ	1	BLQ	BLQ	BLQ	BLQ	BLQ	1	BLQ	BLQ	BLQ
CPT-12S	CPT-86-012S	3-25-94	BLQ	1.1	BLQ	BLQ	1.2	BLQ	1.2	2.3	BLQ	NA	BLQ
CPT-12D	CPT-86-012D	3-25-94	93.5	5.9	BLQ	8.4	7	3.7	19.1	118.5	BLQ	NA	4.1
CPT-13S	CPT-86-013S	3-25-94	BLQ	8.4	BLQ	10.4	5.4	3.1	18.9	56.4	BLQ	NA	6.7
CPT-16S	CPT-86-016S	3-26-94	1	1.9	BLQ	BLQ	BLQ	BLQ	BLQ	2.9	BLQ	BLQ	BLQ
CPT-16(D)	CPT-86-016(D)	3-31-94	BLQ	1.9	BLQ	BLQ	BLQ	BLQ	BLQ	1.9	BLQ	BLQ	BLQ
CPT-18S	CPT-86-018S	3-24-94	BLQ	1.7	2.3	3.8	6.6	4	14.4	18.4	1.4	NA	1.6
CPT-18D	CPT-86-018D	3-24-94	8.3	2.1	BLQ	BLQ	BLQ	BLQ	BLQ	10.4	BLQ	BLQ	BLQ
CPT-18(D)	CPT-86-018(D)	3-31-94	BLQ	3.5	BLQ	BLQ	BLQ	BLQ	BLQ	3.5	BLQ	BLQ	BLQ
CPT-19S	CPT-86-019S	3-24-94	BLQ	BLQ	1.1	1.5	2.7	BLQ	4.2	5.3	BLQ	NA	BLQ
CPT-19D	CPT-86-019D	3-24-94	1.5	BLQ	BLQ	BLQ	BLQ	BLQ	BLQ	1.5	BLQ	BLQ	BLQ
CPT-20S	CPT-86-020S	3-24-94	BLQ	2.1	BLQ	1.5	2.7	1.8	6	8.1	BLQ	NA	1
CPT-20D	CPT-86-020D	3-24-94	BLQ	BLQ	BLQ	BLQ	BLQ	BLQ	BLQ	BLQ	BLQ	BLQ	BLQ
CPT-21S	CPT-86-021S	3-25-94	NA	5.1	BLQ	BLQ	BLQ	BLQ	BLQ	5.1	BLQ	NA	BLQ
CPT-21D	CPT-86-021D	3-25-94	NA	BLQ	BLQ	BLQ	BLQ	BLQ	BLQ	BLQ	BLQ	BLQ	BLQ
CPT-22S	CPT-86-022S	3-26-94	NA	1.9	BLQ	BLQ	BLQ	BLQ	BLQ	1.9	BLQ	BLQ	BLQ
CPT-22D	CPT-86-022D	3-26-94	1.5	BLQ	BLQ	BLQ	BLQ	BLQ	BLQ	1.5	BLQ	BLQ	BLQ
CPT-23S	CPT-86-023S	3-25-94	BLQ	BLQ	BLQ	BLQ	1.7	BLQ	1.7	1.7	BLQ	NA	BLQ
CPT-23D	CPT-86-023D	3-25-94	BLQ	BLQ	BLQ	BLQ	BLQ	BLQ	BLQ	BLQ	BLQ	BLQ	BLQ
CPT-24S	CPT-86-024S	3-26-94	BLQ	BLQ	BLQ	BLQ	BLQ	BLQ	BLQ	BLQ	BLQ	BLQ	BLQ

TABLE 4.3 (CONCLUDED)
FUEL HYDROCARBON COMPOUNDS DETECTED IN GROUNDWATER, MARCH 1994
SITE ST-29 INTRINSIC REMEDIATION TS
PATRICK AFB, FLORIDA

Sample Location	Sample Number	Sample Date	Benzene (µg/L)	Toluene (µg/L)	Ethylbenzene (µg/L)	p-Xylene (µg/L)	m-Xylene (µg/L)	o-Xylene (µg/L)	Total Xylenes (µg/L)	Total BTEX (µg/L)	1,3,5-TMB (µg/L)	1,2,4-TMB (µg/L)	1,2,3-TMB (µg/L)
CPT-24D	CPT-86-024D	3-26-94	BLQ	BLQ	BLQ	BLQ	BLQ	BLQ	BLQ	BLQ	BLQ	BLQ	BLQ
CPT-25S	CPT-86-025S	3-26-94	BLQ	2.1	2.3	4.1	6.9	3.5	14.5	18.9	1.7	NA	1.5
CPT-25D	CPT-86-025D	3-26-94	BLQ	1	BLQ	BLQ	1.4	BLQ	1.4	2.4	BLQ	NA	BLQ
CPT-26S	CPT-86-026S	3-26-94	BLQ	1.1	BLQ	BLQ	BLQ	BLQ	BLQ	1.1	BLQ	BLQ	BLQ
CPT-26D	CPT-86-026D	3-26-94	BLQ	1	BLQ	BLQ	BLQ	BLQ	BLQ	1	BLQ	BLQ	BLQ
CPT-14D	CPT-86-014D	3-25-94	960	16.6	11.5	39.2	36.8	44.2	120.2	1108.3	15.3	NA	23
MW-100	CPT-86-100	3-23-94	4.1	BLQ	BLQ	1.1	1	BLQ	2.1	6.2	BLQ	BLQ	BLQ
PH5	CPT-86-PH5	3-26-94	BLQ	BLQ	BLQ	BLQ	BLQ	BLQ	BLQ	BLQ	BLQ	BLQ	BLQ
MW-101	CPT-86-101	3-23-94	BLQ	BLQ	BLQ	BLQ	BLQ	BLQ	BLQ	BLQ	BLQ	BLQ	BLQ
MW-102	CPT-86-102	3-23-94	BLQ	BLQ	BLQ	BLQ	BLQ	BLQ	BLQ	BLQ	BLQ	BLQ	BLQ
MW-103	CPT-86-103	3-23-94	BLQ	BLQ	BLQ	BLQ	BLQ	BLQ	BLQ	BLQ	BLQ	BLQ	BLQ
PPOL-2-6	CPT-86-PPOL-2-6	3-26-94	BLQ	BLQ	BLQ	BLQ	BLQ	BLQ	BLQ	BLQ	BLQ	BLQ	BLQ
PPOL-2-1	CPT-86-PPOL-2-1	3-26-94	BLQ	BLQ	BLQ	BLQ	1.4	BLQ	1.4	1.4	BLQ	BLQ	BLQ

✓ BLQ = Below quantitation limit, or < 1 µg/L.

✓ NA=Not available.

TABLE 4.4

**FUEL HYDROCARBON COMPOUNDS DETECTED IN GROUNDWATER, MARCH AND MAY 1995
SITE ST-29 INTRINSIC REMEDIATION TS
PATRICK AFB, FLORIDA**

Sample Location	Sample Number	Sample Date	Benzene (µg/L)	Toluene (µg/L)	Ethylbenzene (µg/L)	p-Xylene (µg/L)	m-Xylene (µg/L)	o-Xylene (µg/L)	Total Xylene (µg/L)	Total BTEX (µg/L)	1,3,5 TMB (µg/L)	1,2,4 TMB (µg/L)	1,2,3 TMB (µg/L)	Total TMB (µg/L)	TOC (mg/L)
CPT-02S	2S	3/23/95	167.29	6.25	132.59	95.65	156.04	8.58	260.27	566.4	43.95	203.4	89.18	336.53	14.9
CPT-02S	2S DUP	3/23/95	156.45	6.37	135.4	107.45	168.18	9.36	284.99	583.21	48	202.48	89.97	340.45	16.3
CPT-03D	3D	3/23/95	30.95	BLQ ^w	10.49	22.49	2.96	1.39	26.84	68.28	1.4	1.97	2.87	6.24	13.8
CPT-03D	3D DUP	3/23/95	30.31	0.99	10.39	17.78	1.12	2.05	20.95	62.64	1.42	1.64	3.26	6.32	NA ^w
CPT-03M	3M	3/23/95	134.41	14.03	21.8	58.18	32.43	32.14	122.75	292.99	7.75	30.67	18.58	57	35.8
CPT-03S	3S	3/23/95	1496.39	1526.23	2252.51	2855.12	3466.78	2498.73	8820.63	14095.76	776.78	2903.48	850.57	4530.83	181.9
CPT-09D	9D	3/23/95	44.78	4.35	0.98	4.81	4.01	5.36	14.18	64.29	1.38	1.45	7.26	10.09	21.8
CPT-09S	9S	3/25/95	1.09	BLQ	1.29	1.82	1.73	1.45	5	7.38	1.09	2.46	3.6	7.15	3
CPT-12D	12D	3/25/95	BLQ	BLQ	BLQ	1.21	1.33	0.99	3.53	3.53	1.15	1.33	2.75	5.23	10.9
CPT-12S	12S	3/25/95	BLQ	ND ^d	BLQ	BLQ	1.08	BLQ	1.08	1.08	ND	ND	1.27	1.27	6.1
CPT-26D	26D	3/26/95	BLQ	ND	BLQ	BLQ	0.96	ND	0.96	0.96	1.04	ND	ND	1.04	9.5
CPT-26S	26S	3/26/95	BLQ	1.67	ND	BLQ	BLQ	ND	BLQ	1.67	1.06	1.31	ND	2.37	3.4
CPT-04D	86-4D	3/25/95	BLQ	1	BLQ	1.06	1.13	1.35	3.54	4.54	1.11	ND	1.98	3.09	7.8
CPT-04S	86-4S	3/23/95	BLQ	0.97	BLQ	1.06	1.22	1.3	3.58	4.55	1.27	ND	1.84	3.11	7.5
CPT-04S	86-4S DUP	3/23/95	BLQ	ND	BLQ	BLQ	0.99	ND	0.99	0.99	ND	1.7	1.42	3.12	7.5
CPT-16DD	86-16DD	3/31/95	BLQ	BLQ	BLQ	BLQ	1.03	BLQ	1.03	1.03	ND	ND	ND	ND	4.6
CPT-18D	86-MW18D	3/24/95	ND	ND	ND	BLQ	BLQ	ND	BLQ	BLQ	ND	ND	ND	ND	5.8
CPT-18DD	86-MW18DD	3/31/95	ND	ND	ND	ND	ND	ND	ND	ND	ND	ND	ND	ND	4.2
CPT-18S	86-MW18S	3/24/95	ND	ND	ND	ND	ND	ND	ND	ND	ND	ND	ND	ND	4
MW-100	86-MW100	3/23/95	ND	ND	ND	ND	ND	ND	ND	ND	ND	ND	ND	ND	3.3
CPT-21D	86-MW21D	3/25/95	ND	ND	ND	ND	ND	ND	ND	ND	ND	ND	ND	ND	NA
CPT-21S	86-MW21S	3/25/95	ND	ND	ND	ND	ND	ND	ND	ND	ND	ND	ND	ND	4.9
MW-1 ^w	-	5/95	ND	ND	ND	NA	NA	NA	NA	NA	NA	NA	NA	NA	NA
MW-2 ^w	-	5/95	ND	ND	ND	NA	NA	NA	NA	NA	NA	NA	NA	NA	NA
MW-3 ^w	-	5/95	ND	ND	ND	NA	NA	NA	NA	NA	NA	NA	NA	NA	NA
MW-4 ^w	-	5/95	ND	ND	ND	NA	NA	NA	NA	NA	NA	NA	NA	NA	NA
MW-6 ^w	-	5/95	ND	ND	ND	NA	NA	NA	NA	NA	NA	NA	NA	NA	NA
MW-7 ^w	-	5/95	ND	ND	ND	NA	NA	NA	NA	NA	NA	NA	NA	NA	NA
MW-8 ^w	-	5/95	140	85	270	NA	NA	NA	2450	2945	NA	NA	NA	NA	NA
MW-9 ^w	-	5/95	37	ND	46	NA	NA	NA	ND	83	NA	NA	NA	NA	NA
MW-10 ^w	-	5/95	180	ND	360	NA	NA	NA	220	760	NA	NA	NA	NA	NA
MW-11 ^w	-	5/95	ND	ND	ND	NA	NA	NA	ND	ND	NA	NA	NA	NA	NA
MW-12 ^w	-	5/95	210	ND	700	NA	NA	NA	2310	3220	NA	NA	NA	NA	NA

a/ BLQ = Below limit of quantitation, 1.0 µg/L.

b/ NA = Data not available or sample not analyzed for this parameter.

c/ ND = Compound not detected at the method detection limit.

d/ Sample collected and analyzed by CH2M Hill on May 10 and 11, 1995.

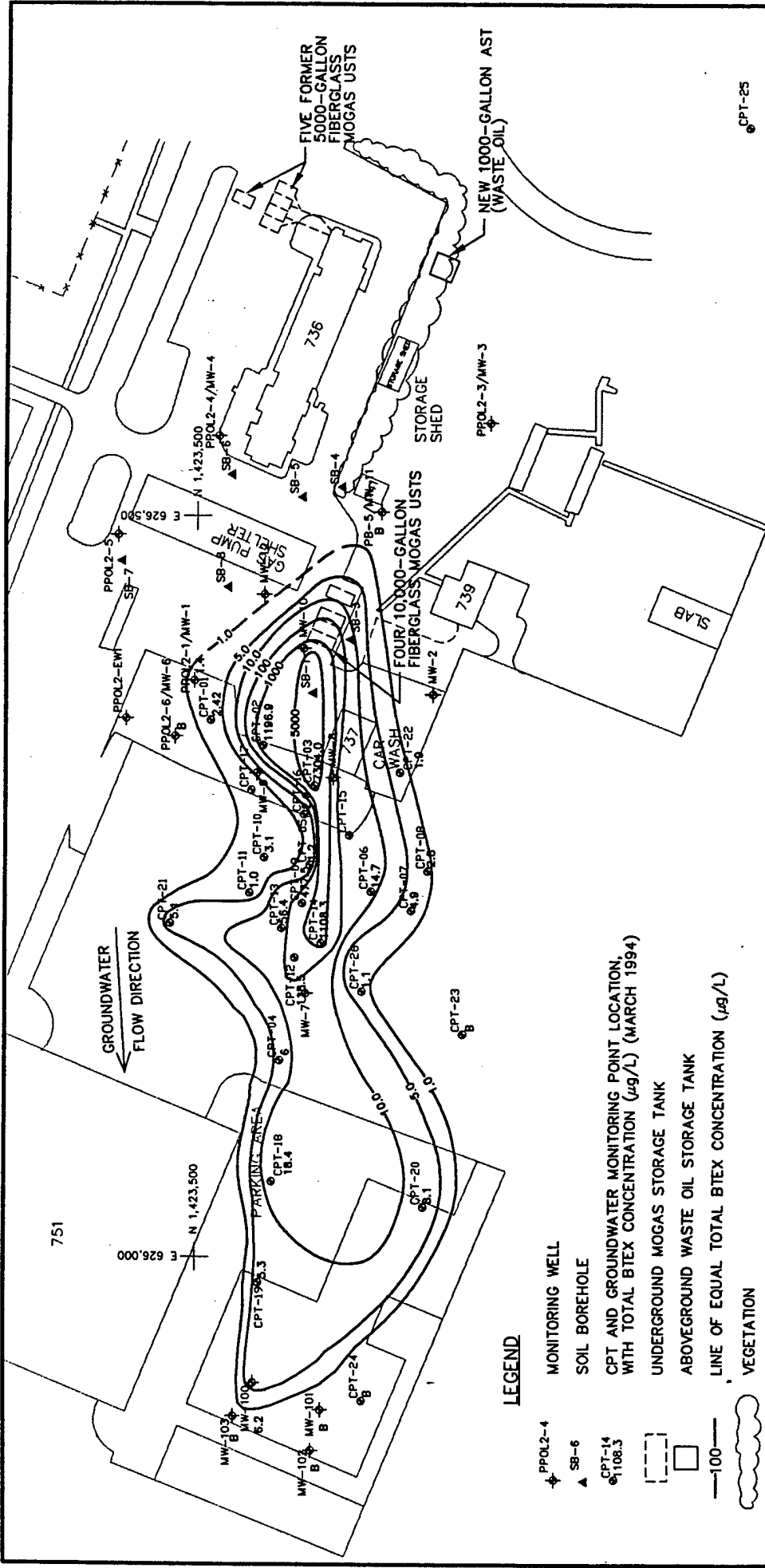

FIGURE 4.2
TOTAL BTEX ISOPLETH MAP
FOR GROUNDWATER
MARCH 1994
 Site ST-29
 Intrinsic Remediation TS
 Patrick Air Force Base, Florida
PARSONS ENGINEERING SCIENCE, INC.
 Denver, Colorado

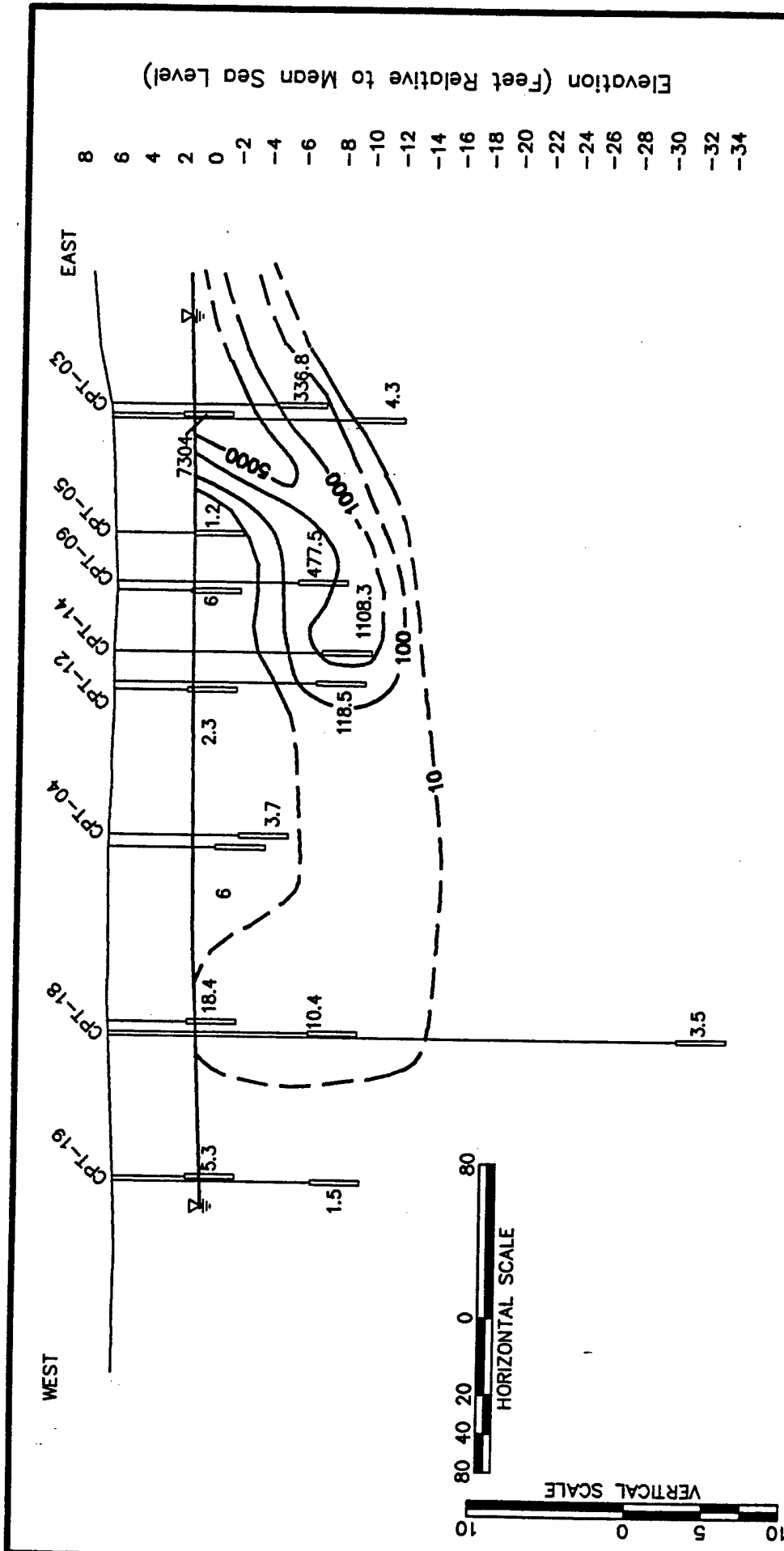

FIGURE 4.3
VERTICAL PROFILE OF
TOTAL BTEX ISOPLETHS
FOR GROUNDWATER
MARCH 1994

Site ST-29
 Intrinsic Remediation TS
 Patrick Air Force Base, Florida



LEGEND

- APPROXIMATE GROUNDWATER SURFACE
- 3.756 WELL OR MONITORING POINT, WITH SCREENED INTERVAL AND TOTAL BTEX CONCENTRATION (µg/L)
- 10 LINE OF EQUAL TOTAL BTEX CONCENTRATION (µg/L) (DASHED WHERE INFERRED)

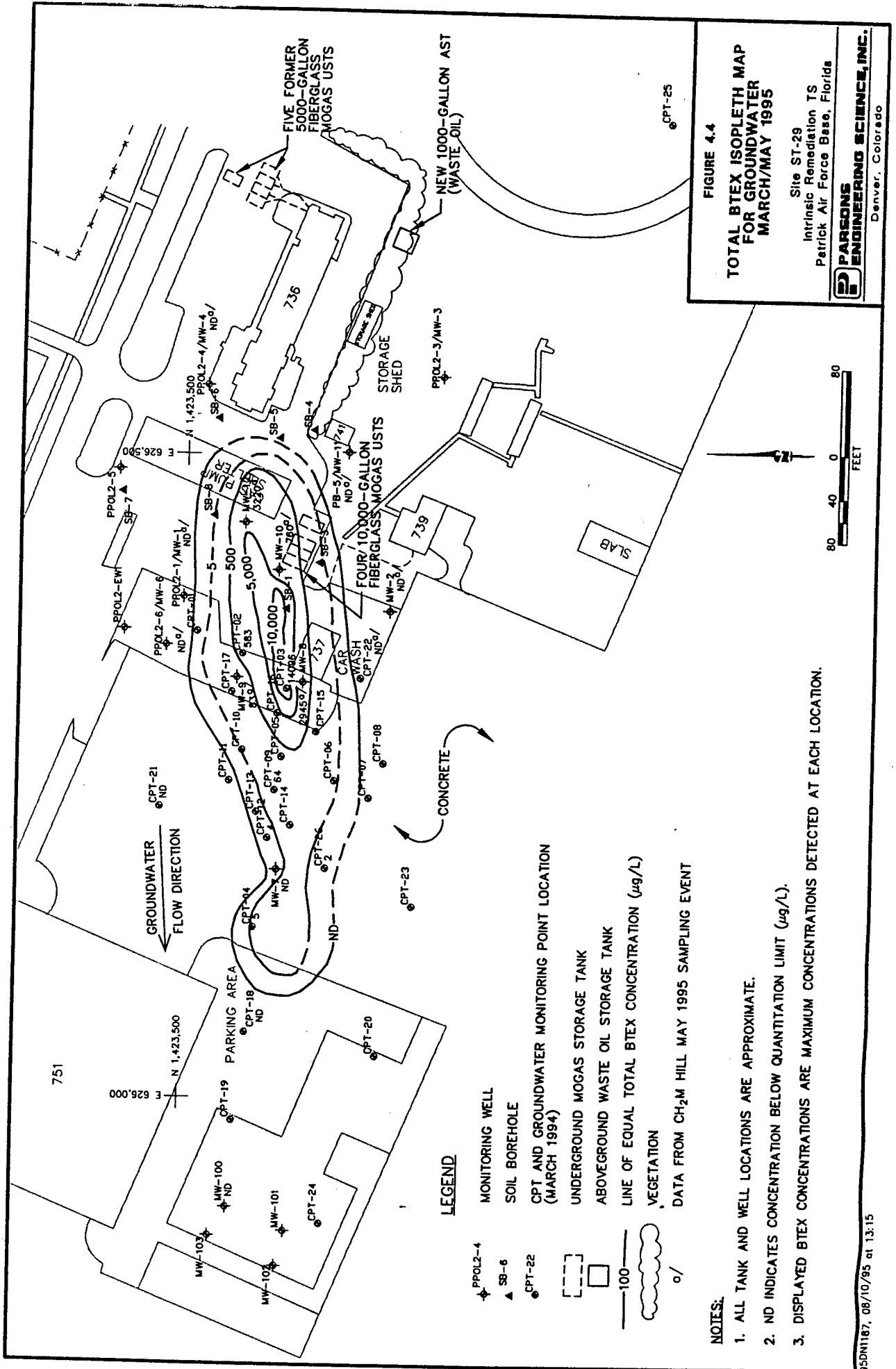

FIGURE 4.4
TOTAL BTEX ISOPLETH MAP FOR GROUNDWATER MARCH/MAY 1995
 Site ST-29
 Intrinsic Remediation TS
 Patrick Air Force Base, Florida
PARSONS ENGINEERING SCIENCE, INC.
 Denver, Colorado

LEGEND

- PPOL2-4 MONITORING WELL
- SB-6 SOIL BOREHOLE
- CPT-22 CPT AND GROUNDWATER MONITORING POINT LOCATION (MARCH 1994)
- UNDERGROUND MOGAS STORAGE TANK
- ABOVEGROUND WASTE OIL STORAGE TANK
- 100 LINE OF EQUAL TOTAL BTEX CONCENTRATION (µg/L)
- VEGETATION
- DATA FROM CH₂M HILL MAY 1995 SAMPLING EVENT

NOTES:

1. ALL TANK AND WELL LOCATIONS ARE APPROXIMATE.
2. ND INDICATES CONCENTRATION BELOW QUANTITATION LIMIT (µg/L).
3. DISPLAYED BTEX CONCENTRATIONS ARE MAXIMUM CONCENTRATIONS DETECTED AT EACH LOCATION.

the plume was approximately 560 feet in length and 200 feet in width at the widest point in March 1994. As defined by the 100 µg/L isopleth, the plume was 300 feet long by 80 feet wide (at its widest point) in March 1994. As indicated by the March 1994 vertical profile, the plume is migrating downward in the vicinity of CPT-03, CPT-05, and CPT-09. Based on March 1994 data, the plume appears to be leveling out downgradient from CPT-14, although the plume geometry is not well defined beyond that point.

In March 1994, 10 monitoring points/wells at the site contained groundwater with dissolved benzene concentrations above the Florida regulatory maximum contaminant level (MCL) of 1 µg/L. Where detected in March 1994, benzene concentrations ranged from 1 to 960 µg/L, with the maximum detected benzene concentration at CPT-14D (the deep point at that nest). Toluene concentrations ranged from 1 to 737 µg/L, with the maximum detected toluene concentration at CPT-14D; most toluene concentrations were in the range of 1 to 18.9 µg/L in March 1994. In March 1994, ethylbenzene was detected much less frequently than benzene or toluene. Where detected, total xylene concentrations ranged from 1 to 5,020 µg/L. The highest concentration was detected in CPT-03S; concentrations elsewhere were generally below 120 µg/L.

Contaminant data collected in March and May 1995, also show that dissolved BTEX contamination is migrating to the west in the direction of groundwater flow. As defined by the 5 µg/L total BTEX isopleth, the plume was approximately 480 feet in length and 120 feet in width at the widest point during this period. Thus, the total BTEX plume contracted considerably between March 1994 and March/May 1995.

Available dissolved BTEX data indicate that the BTEX plume receded and shrank in both the longitudinal and lateral directions between March 1994 and March/May 1995 (compare Figures 4.2 and 4.4). In addition, maximum observed total BTEX concentrations, in general, decreased during the same time period. This is illustrated by Figure 4.5, which was prepared from monitoring data collected from March 1994 and March 1995. For clarity, only sampling points with total BTEX concentrations greater than 10 µg/L are shown on Figure 4.5. Also for purposes of clarity, Figure 4.5 has been split into two plots. Figure 4.5A shows data from sampling points where a decrease in contaminant concentrations was observed between March 1994 and March/May 1995. Figure 4.5B shows data from sampling points where an increase in contaminant

FIGURE 4.5A

PLOT OF TOTAL BTEX VERSUS TIME FOR SAMPLING LOCATIONS
WITH DECREASING BTEX CONCENTRATIONS
SITE ST-29 INTRINSIC REMEDIATION TS
PATRICK AFB, FLORIDA

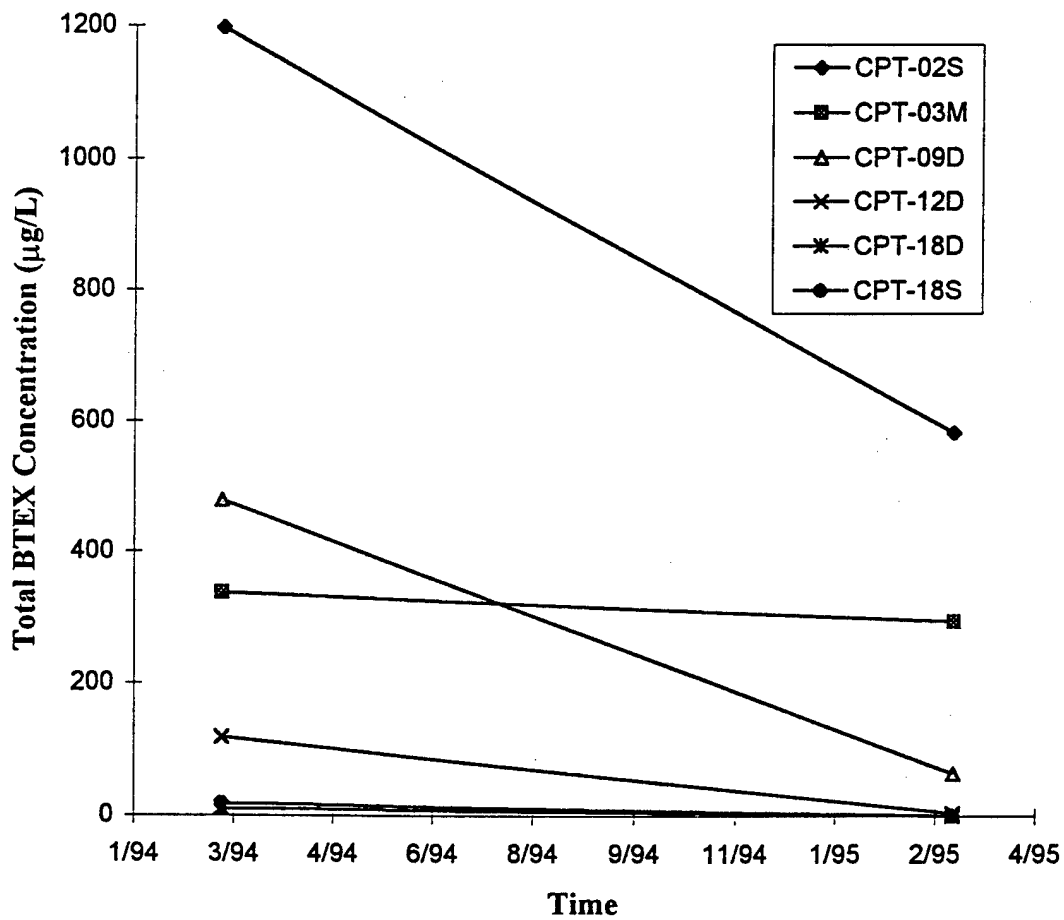
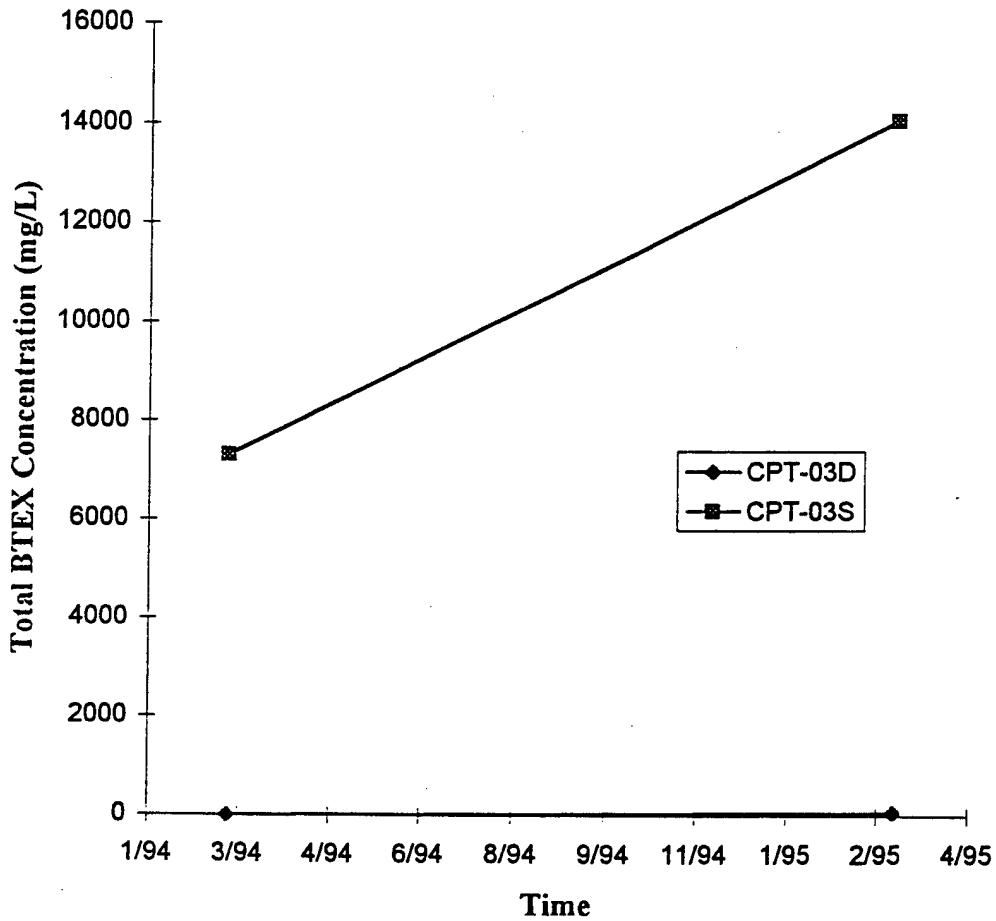

FIGURE 4.5B

PLOT OF TOTAL BTEX VERSUS TIME FOR SAMPLING LOCATIONS
WITH INCREASING BTEX CONCENTRATIONS
SITE ST-29 INTRINSIC REMEDIATION TS
PATRICK AFB, FLORIDA



concentrations was observed between March 1994 and March/May 1995. From these figures it appears that, with the exception of data collected at sampling points CPT-03S and CPT-03D, total BTEX concentrations at the site are decreasing. The combination of decreasing contaminant concentrations and the smaller plume area imply that dissolved BTEX is being removed from the system, because the apparent mass loss cannot be attributed to plume spreading (i.e., dilution due to dispersion).

On the basis of the advective groundwater transport velocity calculated in Section 3.3.2.4, the BTEX plume should have migrated between 110 and 220 feet downgradient (excluding biodegradation and sorption) between March 1994 and March/May 1995. Given that the plume receded during this period, it appears that biodegradation has been effective in preventing downgradient migration of the dissolved BTEX plume. In conjunction with the evidence of decreasing contaminant concentrations, this is a further indication that contaminant mass is being lost, most likely due to biodegradation and other natural attenuation mechanisms.

4.3.3 Groundwater Geochemistry

Microorganisms obtain energy for cell production and maintenance by catalyzing the transfer of electrons from electron donors to electron acceptors. This results in the oxidation of the electron donor and the reduction of the electron acceptor. Electron donors at Site ST-29 are natural organic carbon and fuel hydrocarbon compounds. Fuel hydrocarbons are completely degraded (or detoxified) if they are utilized as the primary electron donor for microbial metabolism (Bouwer, 1992). Electron acceptors are elements or compounds that occur in relatively oxidized states and include oxygen, nitrate, ferrous iron, sulfate, and carbon dioxide. Microorganisms preferentially utilize electron acceptors while metabolizing fuel hydrocarbon (Bouwer, 1992). DO is utilized first as the prime electron acceptor. After the DO is consumed, anaerobic microorganisms use electron acceptors in the following order of preference: nitrate, ferric iron, sulfate, and finally carbon dioxide.

Depending on the type of electron acceptors present (e.g., nitrate, ferric iron, sulfate, or carbon dioxide), pH conditions, and redox potential, anaerobic biodegradation can occur by denitrification, ferric iron reduction, sulfate reduction, or methanogenesis. Other, less common anaerobic degradation mechanisms such as manganese reduction may dominate if the physical and chemical conditions in the subsurface favor use of these

electron acceptors. Anaerobic destruction of the BTEX compounds is associated with the accumulation of fatty acids, production of methane, solubilization of iron, and reduction of nitrate and sulfate (Cozzarelli *et al.*, 1990; Wilson *et al.*, 1990). Environmental conditions and microbial competition will ultimately determine which processes will dominate. Vroblesky and Chapelle (1994) show that the dominant terminal electron accepting process can vary both temporally and spatially in an aquifer with fuel hydrocarbon contamination.

Site ST-29 data for electron acceptors such as nitrate and sulfate do not indicate intrinsic remediation of hydrocarbons in the shallow aquifer by denitrification or sulfate reduction. However, ferrous iron (Fe^{2+}) data suggest a minor amount of anaerobic degradation via ferric iron reduction. Methane data suggest that methanogenesis is the most significant anaerobic process. Geochemical parameters for Site ST-29 groundwater are discussed in the following sections.

4.3.3.1 Dissolved Oxygen

DO concentrations were measured at groundwater monitoring points and at existing monitoring wells in March 1994. Table 4.5 summarizes DO concentrations measured in March 1995. In addition, DO concentrations were measured at select groundwater monitoring points in March 1995. Table 4.6 summarizes DO concentrations measured in March 1995. Figure 4.6 is an isopleth map showing the distribution of DO concentrations in groundwater in March 1994, and Figure 4.7 is a vertical section through the DO plume during this same period. Comparison of Figures 4.2 and 4.6 and Figures 4.3 and 4.7 shows graphically that areas with elevated total BTEX concentrations correlate with areas with depleted DO concentrations. This is a strong indication that aerobic biodegradation of the BTEX compounds is occurring at the site. Based on the background DO concentrations measured at the site in March 1994 (up to 3.7 mg/L), it is likely that DO is an important electron acceptor at Site ST-29.

The following equations describe the overall stoichiometry of aromatic hydrocarbon mineralization caused by microbial biodegradation. In the absence of microbial cell production, the oxidation (mineralization) of benzene to carbon dioxide and water is given by:

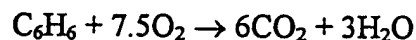

TABLE 4.5

GROUNDWATER GEOCHEMICAL DATA, MARCH 1994
SITE ST-29 INTRINSIC REMEDIATION TS
PATRICK AFB, FLORIDA

Sample Location	Sample Number	Water Temp. (°C)	pH	Conductivity (µmhos/cm)	Dissolved Oxygen (mg/L)	Redox Potential (mV)	Total Alkalinity (mg/L)	Hydrogen Sulfide (mg/L)	Ferrous Iron (mg/L)	Chloride (mg/L)	Sulfate (mg/L)	NO ₂ +NO ₃ Nitrogen (mg/L)	TOC ^v (mg/L)	Methane (mg/L)
CPT-01	CPT-86-001	24.7	NA ^v	NA	0.4	NA	NA	NA	NA	44.4	4.37	0.13	14	4.99
CPT-02D	CPT-86-002D	24.7	7.1	771	0.6	-190	330	0.4	0.4	45.7	ND2 ^d	0.13	6.8	5.953
CPT-02S	CPT-86-002S	24.7	6.7	1061	0.2	-156	498	0.2	1.6	42.6	ND2	0.12	16.9	14.953
CPT-03D	CPT-86-003D	NA	7.3	721	NA	-255	315	1	0.4	41.6	ND2	0.12	5.4	1.63
CPT-03M	CPT-86-003M	26.4	7.1	898	0.2	-50	398	0	0.3	40.7	2.52	0.11	10.9	3.164
CPT-03S	CPT-86-003S	26.4	6.7	1733	0.1	-208	520	0.1	1.2	132	118	14.8	63.1	14.021
CPT-04D	CPT-86-004D	26.1	7.2	457	0.2	-266	212	0.2	0.6	12.4	1.47	0.09	5.6	3.756
CPT-04S	CPT-86-004S	26.9	6.9	469	0.3	-286	215	0.5	0.6	12.5	ND2	0.19	6.6	7.661
CPT-05S	CPT-86-005S	26.4	7.3	488	1.1	-160	215	0.1	0.1	23.6	6.86	0.17	12	4.858
CPT-06S	CPT-86-006S	25.1	7.6	437	0.2	-278	148	1.5	0.3	47.8	7.03	0.13	3.8	6.595
CPT-07S	CPT-86-007S	25.3	7.2	577	0.2	-250	254	1.2	1	30.2	2.52	0.12	3.4	6.339
CPT-08S	CPT-86-008S	25	7.1	974	0.2	-60	420	0	1.9	44.7	8.51	0.1	10.1	1.742
CPT-09D	CPT-86-009D	27.8	7.1	938	0.3	-200	422	0.6	0.2	34.7	15.3	0.11	12	4.236
CPT-09S	CPT-86-009S	27.3	7.3	530	0.2	-24	340	0	0.2	14.3	6.64	0.1	10.2	3.797
CPT-10S	CPT-86-010S	26	7.3	460	0.1	-35	192	0	0.2	26.6	9.5	0.13	21.3	3.493
CPT-11S	CPT-86-011S	25.9	7.2	508	0.1	-35	210	0	0.4	12.7	15.9	0.15	NA	4.244
CPT-12D	CPT-86-012D	27.1	7.2	715	0.4	10	329	0.1	0.1	28.1	3.86	0.12	8.1	0.983
CPT-12S	CPT-86-012S	27.3	7	564	0.9	30	266	0	0.1	15.2	8.38	0.1	10.5	5.372
CPT-13S	CPT-86-013S	25.7	7.3	801	0.1	-230	362	0.6	0.3	35.5	6.94	0.12	7.2	2.043
CPT-14D	CPT-86-014D	25.5	7	906	0.3	-240	460	0.6	0.3	34.6	3.68	0.11	12.8	8.793
CPT-16D	CPT-86-016D	26.7	NA	NA	2.7	NA	NA	0.3	NA	NA	NA	NA	NA	NA
CPT-16S	CPT-86-016S	25.5	7	776	0.1	-190	231	0.1	0.4	37.9	8.23	0.13	9.4	0.781
CPT-18D	CPT-86-018D	26.1	7.1	620	0.3	-60	294	0.2	0.3	15	1.85	0.11	5.6	4.56
CPT-18DD	CPT-86-018DD	27.3	NA	NA	2.3	NA	NA	0	NA	NA	NA	NA	NA	NA
CPT-18S	CPT-86-018S	26.6	6.9	834	2	25	286	0	0.5	36.6	86	0.12	7.8	NA
CPT-19D	CPT-86-019D	26.6	7.1	744	0.2	-50	328	0.2	0.2	33.7	1.51	0.1	7.3	2.136
CPT-19S	CPT-86-019S	NA	7	800	NA	41	335	0	0.1	37.4	8.85	0.11	10.3	0.924
CPT-20D	CPT-86-020D	25.7	7.1	842	0.3	-44	380	0.1	0.2	52	ND2	0.07	8.6	1.114
CPT-20S	CPT-86-020S	25	7	368	1.5	23	148	0	0.3	9.83	25.5	0.1	3.6	1.278
CPT-21D	CPT-86-021D	26.4	7.2	716	0.2	-20	304	0.1	0.2	29.8	13.3	0.14	6.1	0.46
CPT-21S	CPT-86-021S	26	7.1	610	3.2	20	245	0	0.2	26.6	25.5	0.29	7.6	2.414
CPT-22D	CPT-86-022D	25.4	6.9	936	0.1	-287	415	5	0.2	NA	NA	0.12	11.4	0.866

TABLE 4.5 (CONCLUDED)

GROUNDWATER GEOCHEMICAL DATA, MARCH 1994
 SITE ST-29 INTRINSIC REMEDIATION TS
 PATRICK AFB, FLORIDA

Sample Location	Sample Number	Water Temp. (°C)	pH	Conductivity (µmhos/cm)	Dissolved Oxygen (mg/L)	Redox Potential (mV)	Total Alkalinity (mg/L)	Hydrogen Sulfide (mg/L)	Ferrous Iron (mg/L)	Chloride (mg/L)	Sulfate (mg/L)	NO ₂ +NO ₃ Nitrogen (mg/L)	TOC ^a (mg/L)	Methane (mg/L)
CPT-22S	CPT-86-022S	25.5	6.8	1271	0.3	-153	450	0	1.2	66.6	128	0.07	10	3.218
CPT-23D	CPT-86-023D	26.7	7.1	779	0.4	-167	332	0.2	0.2	36.1	1.49	0.1	8.2	2.282
CPT-23S	CPT-86-023S	26.5	6.9	757	3.5	54	346	0	0.2	23.4	ND2	0.12	6.4	1.992
CPT-24D	CPT-86-024D	26	7.5	376	0.3	-60	192	0.1	0.1	5.46	3.61	0.1	2.8	0.686
CPT-24S	CPT-86-024S	25.7	7	358	1.7	30	190	0	0.1	6.63	ND2	0.12	5.6	2.204
CPT-25D	CPT-86-025D	NA	7.1	892	NA	62	371	0	NDI ^d	54.7	6.16	0.12	15.7	1.556
CPT-25S	CPT-86-025S	25	7.3	664	3.7	53	157	0	NDI	28	51.9	0.12	15.7	0.147
CPT-26D	CPT-86-026D	26.2	7	751	0.2	-293	311	3	0.4	44.9	19.8	0.11	8.3	2.961
CPT-26S	CPT-86-026S	26	7.6	558	2.2	-20	264	0	0.3	15.1	1.22	0.12	5	3.569
MW-100	CPT-86-100	25.9	7.2	607	0.5	-241	331	0.2	0.1	24.9	16.3	0.12	18.6	2.821
MW-101	CPT-86-101	26.5	7.2	533	0.3	-247	287	0.8	0.1	21.6	5.75	0.13	9	2.308
MW-102	CPT-86-102	25.8	7.2	523	0.2	-281	250	0.5	0.1	17.9	3.51	0.12	7.6	3.256
MW-103	CPT-86-103	25.4	7.4	445	0.1	-271	209	1	0.1	12.5	4.69	0.11	2.6	5.291
PI35	CPT-86-PI35	24.9	7.1	743	0.2	-140	291	NA	NDI	51.4	4.45	0.1	NA	4.414
PPOL-2-1	CPT-86-PPOL-2-1	26.3	7.1	747	0.1	-220	305	0.7	0.6	44	3.2	NDI	NA	5.33
PPOL-2-6	CPT-86-PPOL-2-6	27.2	7	30100	0.2	-230	334	0.8	NA	10200	1150	NDI	NA	0.034

^a TOC = Total organic carbon.

^b NA = Not available.

^c ND2 = <0.5 mg/L.

^d NDI = <0.05 mg/L.

TABLE 4.6

GROUNDWATER GEOCHEMICAL DATA, MARCH 1995
SITE ST-29 INTRINSIC REMEDIATION TS
PATRICK AFB, FLORIDA

Sample Location	Sample Number	Sample Date	pH	Conductivity (µm/cm)	Redox (mv)	Alkalinity (mg/L CaCO3)	Chloride (mg/L)	Dissolved Oxygen (mg/L)	Nitrate + Nitrite (mg/L)	Ammonia (mg/L)	Ferrous Iron (mg/L)	Manganese (mg/L)	Sulfate (mg/L)	Hydrogen Sulfide (mg/L)	Carbon Dioxide (mg/L)	Methane (mg/L)
CPT-02S	2S	3/23/95	6.54	998	-231	404	62.7	0.1	0.06	3.83	1.1	<0.1	1.13	NA ^a	420	12.846
CPT-02S	2S DUP	3/23/95	6.53	995	-225	407	67.7	0.1	0.07	3.79	1.1	<0.1	1.08	NA	416	14.15
CPT-03D	3D	3/23/95	7.02	787	-348	341	46.5	0.1	0.08	1.18	<0.05	<0.1	15.7	5	144	2.57
CPT-03D	3D DUP	3/23/95	7.04	786	-347	NA	NA	NA	NA	NA	NA	NA	NA	NA	NA	NA
CPT-03M	3M	3/23/95	6.77	1019	-343	447	42.6	<0.1	0.06	6.13	<0.05	<0.1	19.6	NA	338	12.437
CPT-03S	3S	3/23/95	6.72	2010	-357	920	129	<0.1	<0.05	18.2	0.1	<0.1	14	NA	780	15.534
CPT-09D	9D	3/25/95	6.78	995	-293	469	51.1	0.1	0.06	3.85	<0.05	<0.1	2.23	5	284	9.839
CPT-09S	9S	3/25/95	7.38	391	-279	180	9.46	0.1	0.07	1.71	0.1	<0.1	1.52	1	80	5.822
CPT-12D	12D	3/25/95	6.93	946	-340	359	56.9	<0.1	0.05	2.37	<0.05	<0.1	49.7	5	202	0.882
CPT-12S	12S	3/25/95	7.05	498	-306	220	14.4	<0.1	0.07	4.04	0.3	<0.1	0.98	1	142	12.339
CPT-26D	26D	3/26/95	6.88	837	-342	357	51.2	0.1	0.06	2.61	<0.05	<0.1	3.31	5	192	3.756
CPT-26S	26S	3/26/95	6.87	440	-269	202	13.2	0.1	0.07	1.01	0.3	<0.1	0.94	0.7	154	9.009
CPT-04D	86-4D	3/25/95	7.04	540	-325	259	18.4	<0.1	0.07	2.53	0.1	<0.1	2.98	5	90	5.095
CPT-04S	86-4S	3/23/95	6.85	543	-289	263	15.8	0.1	0.07	3.6	0.1	<0.1	1.17	1	138	11.63
CPT-04S	86-4S DUP	3/23/95	NA	NA	NA	NA	NA	NA	NA	NA	NA	NA	NA	NA	NA	10.594
CPT-16DD	86-16DD	3/31/95	7.13	26900	-288	307	9830	0.1	<0.05	16.9	<0.05	<0.1	1200	NA	238	0.074
CPT-18D	86-NW18D	3/24/95	6.87	652	-316	289	29.6	0.1	0.07	1.52	0.1	<0.1	1.08	2	98	6.116
CPT-18DD	86-NW18DD	3/31/95	7.19	26500	-171	335	9080	0.2	<0.05	16.2	0.1	<0.1	967	<0.1	276	0.068
CPT-18S	86-NW18S	3/24/95	6.85	675	-287	276	18.3	0.1	0.07	0.35	0.2	<0.1	59.6	0.7	110	3.379
MW-100	86-NW100	3/23/95	7.32	429	-253	205	15.2	<0.1	0.07	0.23	0.3	<0.1	10	0.3	132	NA
CPT-21D	86-MW21D	3/25/95	7.18	674	-307	287	28.2	<0.1	0.07	0.47	0.1	NA	38.8	5	96	0.749
CPT-21S	86-MW21S	3/25/95	6.92	381	-239	177	12.3	0.1	0.08	2.94	0.6	NA	0.52	0.7	190	9.857

a/ NA = Data not available.

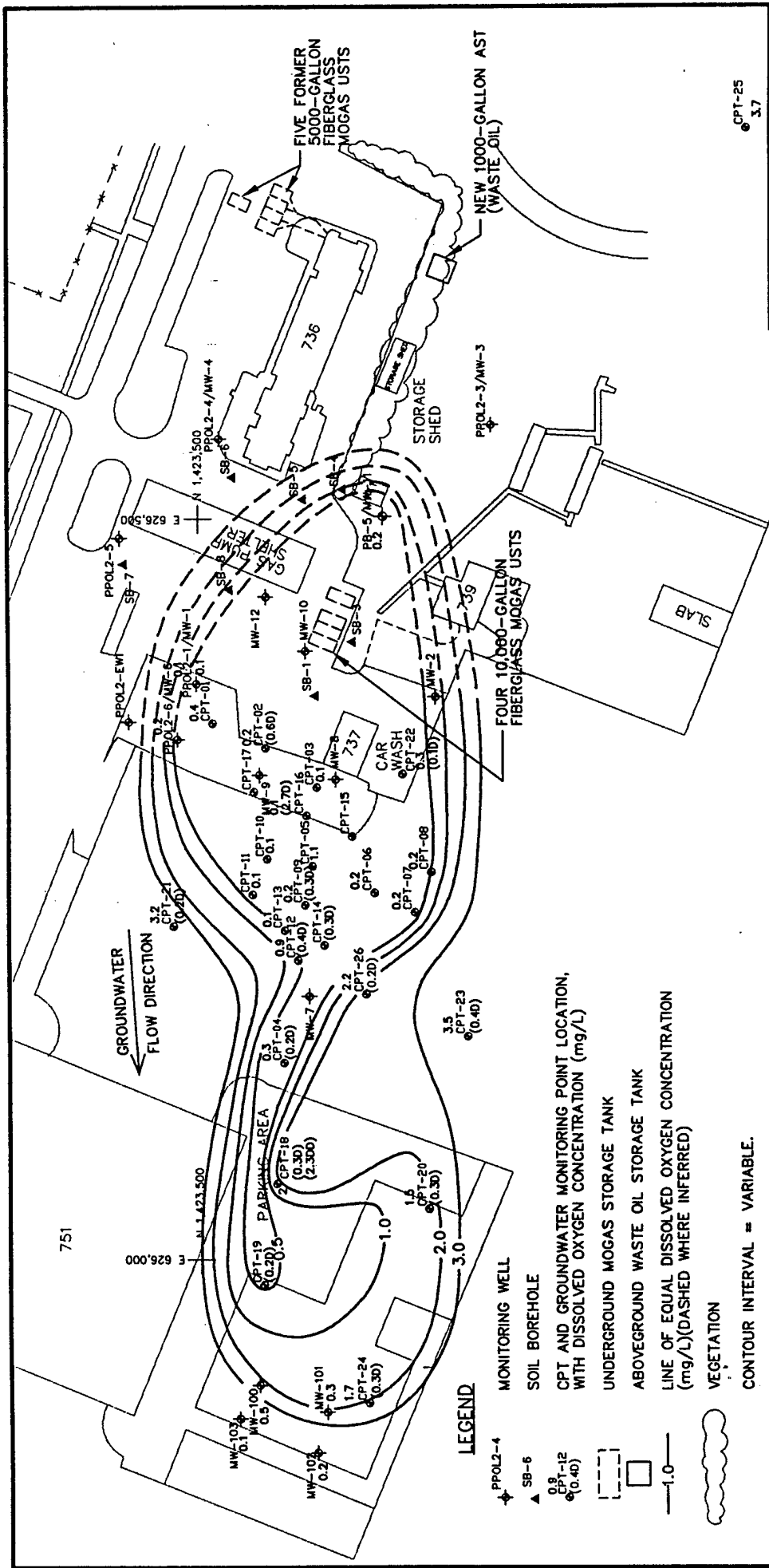
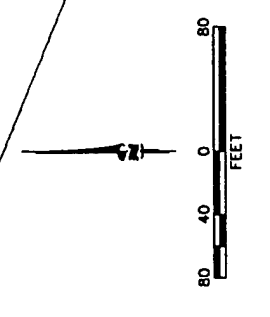

FIGURE 4.6
DISSOLVED OXYGEN ISOPLETH
MAP FOR GROUNDWATER
MARCH 1994

Site ST-29
 Intrinsic Remediation TS
 Patrick Air Force Base, Florida

PARSONS
ENGINEERING SCIENCE, INC.
 Denver, Colorado



- NOTES:**
1. ALL TANK AND WELL LOCATIONS ARE APPROXIMATE.
 2. "D" INDICATES READING FROM THE DEEPER WELL IN A NEST.
 3. "DD" INDICATES READING FROM THE DEEPEST WELL IN A NEST.
 4. WHERE VALUES FROM DIFFERENT DEPTHS DIFFER, THE VALUE FROM THE DEPTH CORRESPONDING WITH THE HIGHEST TOTAL BIEX CONCENTRATION WAS USED TO GENERATE CONTOURS.

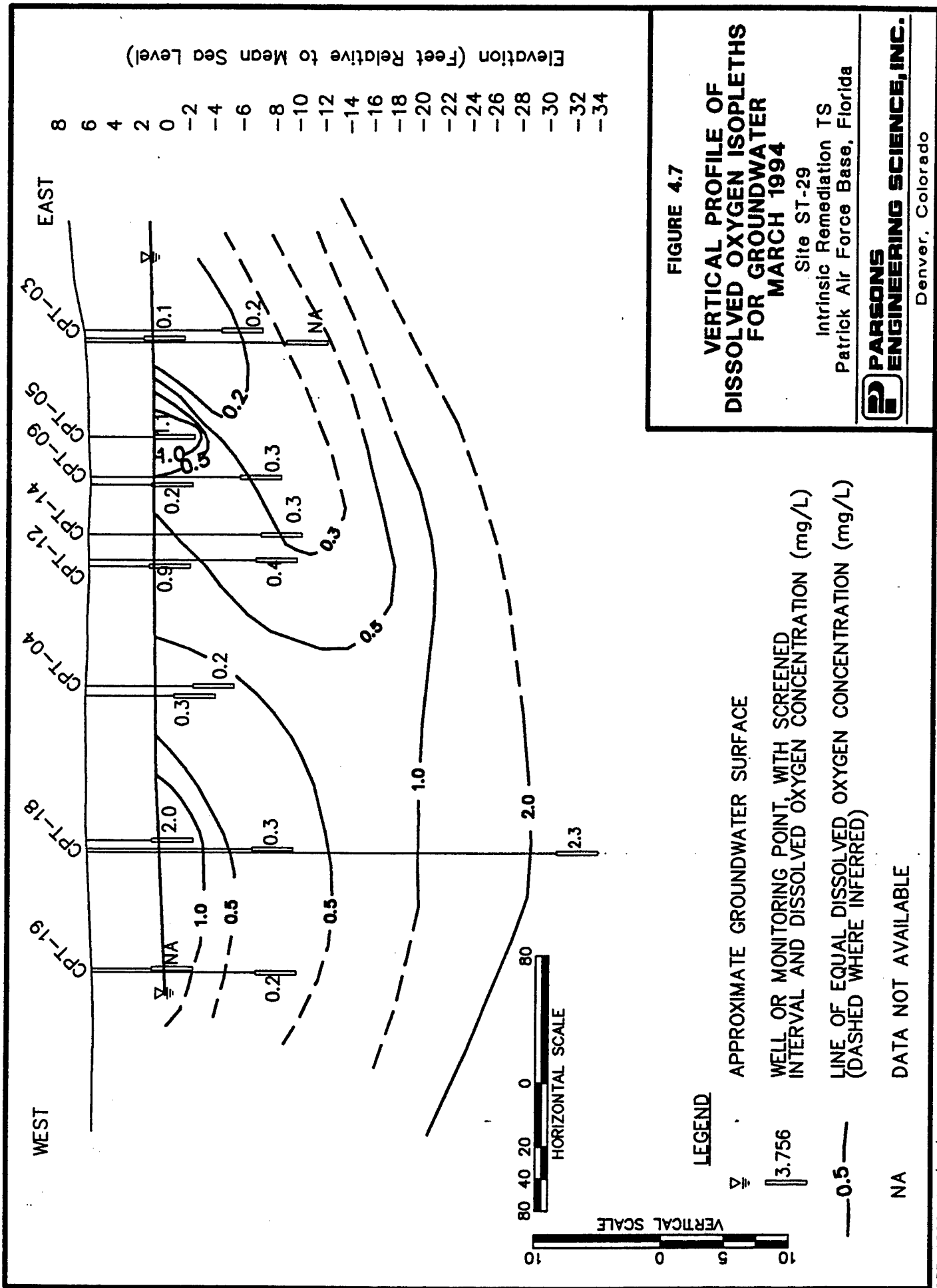

Therefore, 7.5 moles of oxygen are required to metabolize 1 mole of benzene. On a mass basis, the ratio of oxygen to benzene is given by:

Molecular weights:	Benzene	$6(12) + 6(1) = 78$ grams (gm)/mole
	Oxygen	$7.5(32) = 240$ gm/mole

$$\text{Mass Ratio of Oxygen to Benzene} = 240/78 = 3.08:1$$

Therefore, in the absence of microbial cell production, 3.08 mg of oxygen are required to completely metabolize 1 mg of benzene.

Similar calculations can be completed for toluene (3.13 mg oxygen to 1 mg toluene), ethylbenzene (3.17 mg oxygen to 1 mg ethylbenzene), and the xylenes (3.17 mg oxygen to 1 mg xylene). The average mass ratio of oxygen to total BTEX is thus 3.14:1. This means that approximately 0.32 mg of BTEX is mineralized for every 1.0 mg of DO consumed. With a background DO concentration of approximately 3.7 mg/L, the shallow groundwater at this site has the capacity to assimilate 1.2 mg/L (1,200 $\mu\text{g/L}$) of total BTEX. This is a conservative estimate of the assimilative capacity of DO because microbial cell mass production was not taken into account by the stoichiometry shown above.

When cell mass production is accounted for, the mineralization of benzene to carbon dioxide and water is given by:

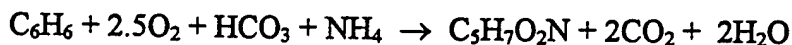

From this it can be seen that only 2.5 moles of DO are required to mineralize 1 mole of benzene when cell mass production is taken into account. On a mass basis, the ratio of DO to benzene is given by:

Molecular weights:	Benzene	$6(12) + 6(1) = 78$ gm/mole
	Oxygen	$2.5(32) = 80$ gm/mole

$$\text{Mass Ratio of Oxygen to Benzene} = 80/78 = 1.03:1$$

Based on these stoichiometric relationships, 1.03 mg of oxygen are required to mineralize 1 mg of benzene. Similar calculations can be made for toluene, ethylbenzene, and the xylenes. Based on these calculations, approximately 0.97 mg of BTEX is mineralized to carbon dioxide and water for every 1.0 mg of DO consumed. With a

background DO concentration of approximately 3.7 mg/L, the shallow groundwater at this site has the capacity to assimilate 3.6 mg/L (3,600 µg/L) of total BTEX if microbial cell mass production is taken into account.

4.3.3.2 Nitrate/Nitrite

Concentrations of nitrate + nitrite [as nitrogen (N)] were measured at groundwater monitoring points and at existing monitoring wells in March 1994. Table 4.5 summarizes measured nitrate and nitrite concentrations in March 1994. Concentrations of nitrate + nitrite (as N) were measured at select groundwater monitoring points in March 1995. Table 4.6 summarizes measured nitrate and nitrite concentrations in March 1995. With the exception of one anomalously high nitrate concentration in March 1994 (14.8 mg/L at CPT-03), nitrate concentrations are extremely low at this site, ranging from <0.05 mg/L to only 0.29 mg/L. Figure 4.8 is an isopleth map showing the distribution of nitrate + nitrite (as N) in groundwater. Comparison of this figure with Figure 4.2 shows graphically that areas with elevated total BTEX concentrations have slightly elevated nitrate + nitrite concentrations. The extremely low background nitrate concentrations observed at this site suggest that anaerobic biodegradation of the BTEX compounds by nitrate reduction is not a significant removal mechanism.

4.3.3.3 Ferrous Iron

Ferrous iron concentrations were measured at groundwater monitoring points and at existing monitoring wells in March 1994. Table 4.5 summarizes ferrous iron concentrations in March 1994. Ferrous iron concentrations were measured at select groundwater monitoring points in March 1995. Table 4.6 summarizes ferrous iron concentrations in March 1995. Figure 4.9 is an isopleth map showing the distribution of ferrous iron in groundwater in March 1994. Comparison of Figures 4.9 and 4.2 shows graphically that the area nearest the car wash with elevated total BTEX concentrations has slightly elevated ferrous iron concentrations. This suggests that ferric iron is potentially being reduced to ferrous iron during biodegradation of BTEX compounds. The highest measured ferrous iron concentration (March 1994), 1.9 mg/L, was observed at CPT-08. A ferrous iron concentration of 1.2 mg/L (March 1994) was observed at CPT-03 (shallow), which is also the location of the highest detected BTEX concentration. Background concentrations of ferrous iron are generally at or below 0.1 mg/L, as measured at wells with little or no known BTEX contamination.

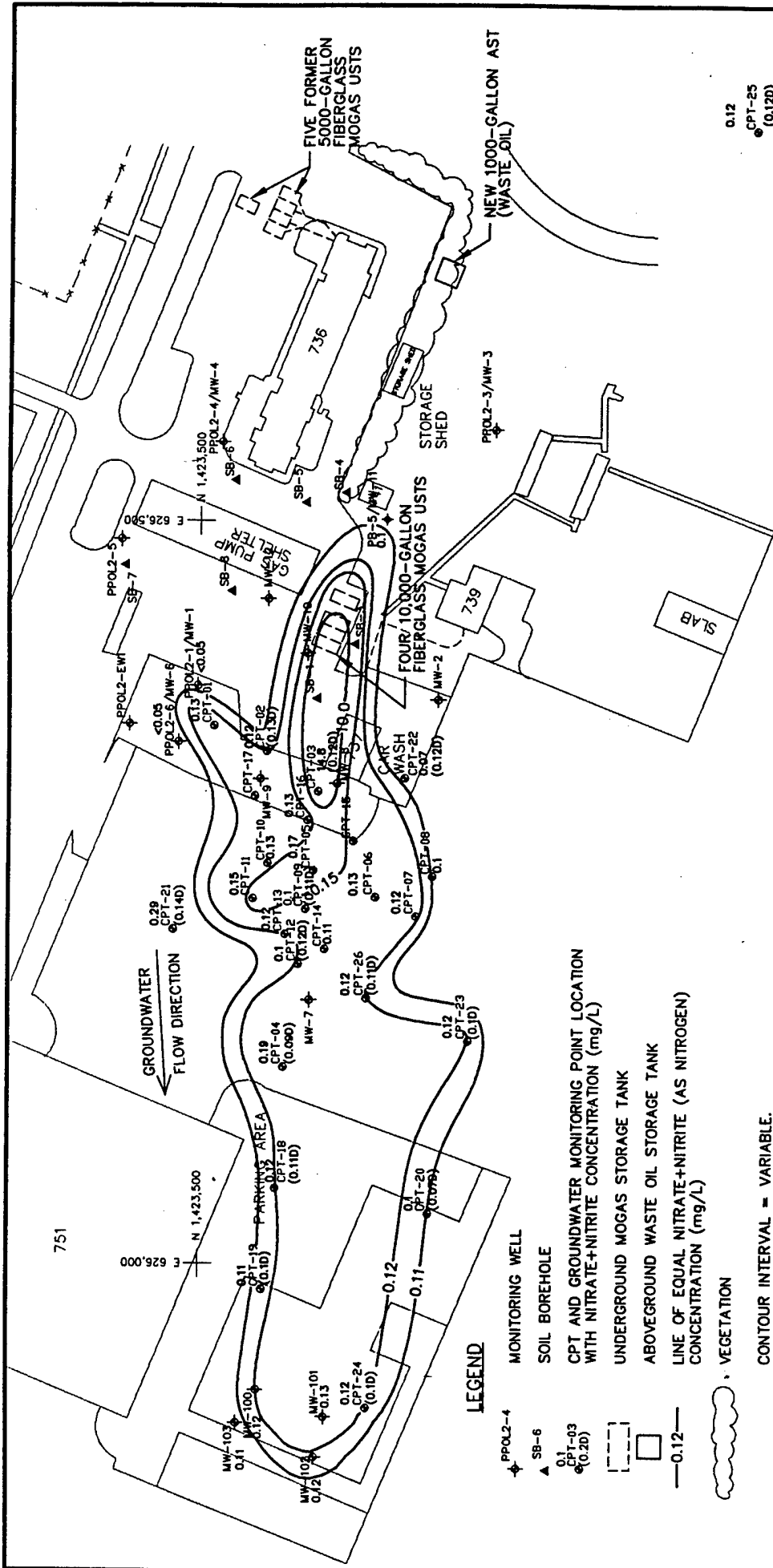
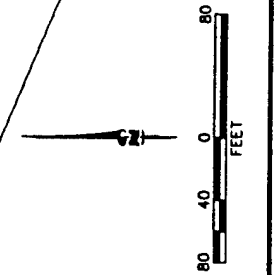

FIGURE 4.8

NITRATE+NITRITE (AS NITROGEN) ISOPLETH MAP FOR GROUNDWATER MARCH 1994

Site ST-29
 Intrinsic Remediation TS
 Patrick Air Force Base, Florida

PARSONS ENGINEERING SCIENCE, INC.
 Denver, Colorado



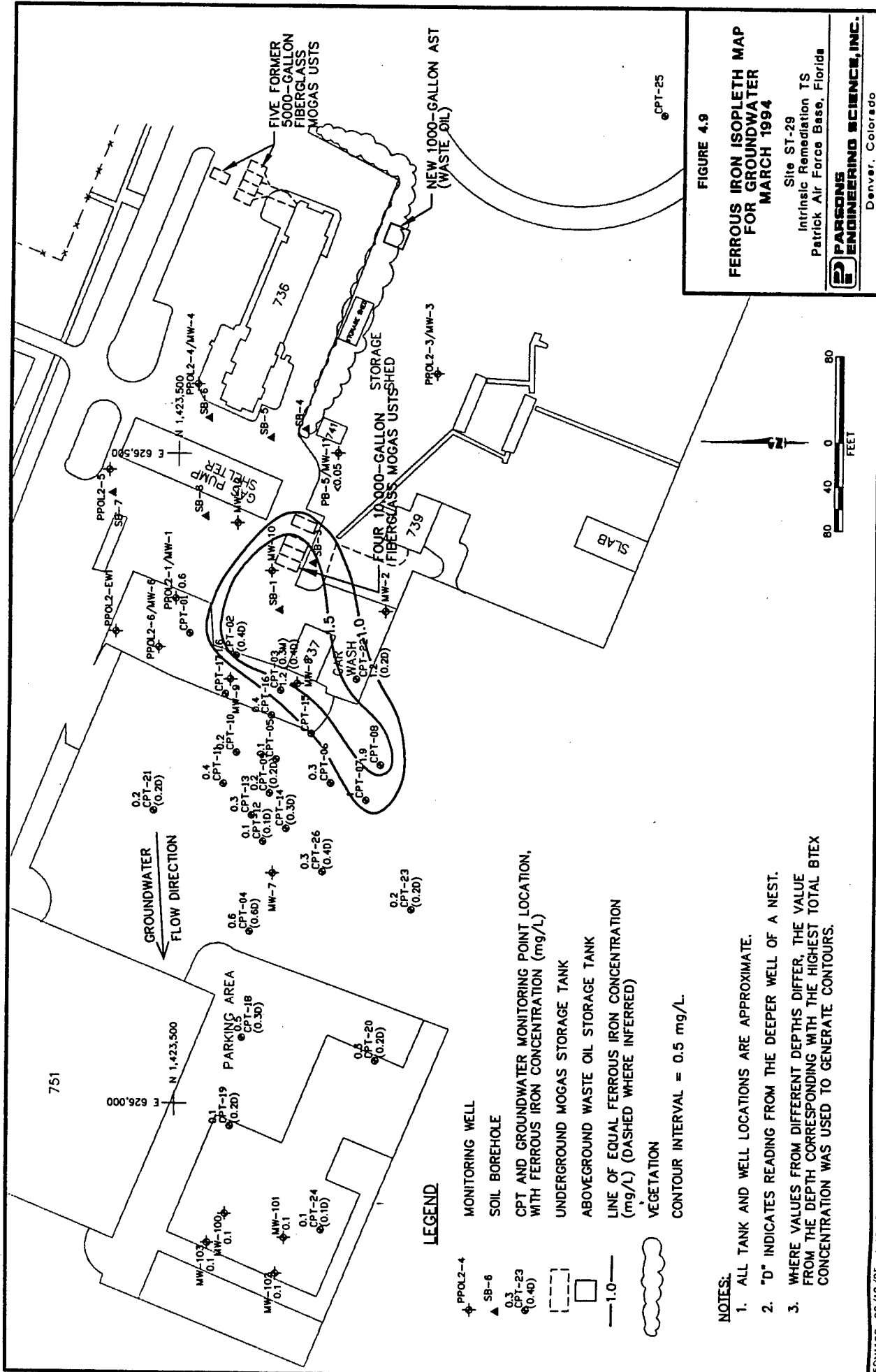
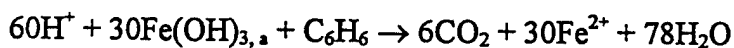

FIGURE 4.9
FERROUS IRON ISOPLETH MAP FOR GROUNDWATER MARCH 1994
 Site ST-29
 Intrinsic Remediation TS
 Patrick Air Force Base, Florida
PARSONS ENGINEERING SCIENCE, INC.
 Denver, Colorado

The following equations describe the overall stoichiometry of benzene oxidation by iron reduction caused by anaerobic microbial biodegradation. In the absence of microbial cell production, the mineralization of benzene is given by:



Therefore, 30 moles of ferric iron are required to metabolize 1 mole of benzene. On a mass basis, the ratio of ferric iron to benzene is given by:

Molecular weights:	Benzene	$6(12) + 6(1) = 78$ gm/mole
	Ferric Iron	$30(106.85) = 3205.41$ gm/mole

$$\text{Mass ratio of ferric iron to benzene} = 3205.41/78 = 41.1:1$$

Therefore, in the absence of microbial cell production, 41.1 mg of ferric iron are required to completely metabolize 1 mg of benzene. Alternatively, the mass ratio of ferrous iron produced during respiration to benzene degraded can be calculated and is given by:

Molecular weights:	Benzene	$6(12) + 6(1) = 78$ gm/mole
	Ferrous Iron	$30(55.85) = 1675.5$ gm/mole

$$\text{Mass ratio of ferrous iron to benzene} = 1675.5/78 = 21.5:1$$

Therefore, 21.5 mg of ferrous iron are produced during mineralization of 1 mg of benzene.

Similar calculations can be completed for toluene (21.86 mg of Fe^{2+} produced during mineralization of 1 mg of toluene), ethylbenzene (22 mg of Fe^{2+} produced during mineralization of 1 mg of ethylbenzene), and the xylenes (22 mg of Fe^{2+} produced during mineralization of 1 mg of xylene). The average mass ratio of Fe^{2+} produced during total BTEX mineralization is thus 21.8:1. This means that approximately 1 mg of BTEX is mineralized for every 21.8 mg of Fe^{2+} produced. The highest measured Fe^{2+} concentration was 1.9 mg/L. This suggests that the shallow groundwater at this site has the capacity to assimilate 0.09 mg/L (90 $\mu\text{g/L}$) of total BTEX during iron reduction. This is a conservative estimate of the assimilative capacity of iron because microbial cell mass production has not been taken into account by the stoichiometry shown above (see Section 4.3.3.1). In addition, this calculation is based on observed ferrous iron concentrations and not on the amount of ferric hydroxide available in the aquifer. Therefore, iron assimilative capacity could be much higher.

4.3.3.4 Sulfate

Sulfate concentrations were measured at groundwater monitoring points and at existing monitoring wells in March 1994. Table 4.5 summarizes measured sulfate concentrations in March 1994. Sulfate concentrations were measured at select groundwater monitoring points in March 1995. Table 4.6 summarizes measured sulfate concentrations in March 1995. No clear sulfate concentration trends are apparent at the site, and sulfate concentrations do not show a direct inverse relationship with BTEX concentrations (i.e., depleted sulfate concentrations are not present in all areas with elevated BTEX concentrations). In fact, sulfate concentrations are slightly to significantly elevated in areas associated with elevated BTEX concentrations (e.g., at CPT-03S and CPT-09D, March 1994). It appears that sulfate is not being utilized as an electron acceptor.

4.3.3.5 Methane in Groundwater

Methane concentrations were measured at groundwater monitoring points and at existing monitoring wells in March 1994. Table 4.5 summarizes methane concentrations in March 1994. Methane concentrations were measured at select groundwater monitoring points in March 1995. Table 4.6 summarizes methane concentrations in March 1995. Figure 4.10 is an isopleth map showing the distribution of methane in groundwater in March 1994. Figure 4.11 is a vertical profile of methane concentrations in March 1994. Comparison of Figures 4.2 and 4.10 and Figures 4.3 and 4.11 shows graphically that areas with elevated total BTEX concentrations correlate with elevated methane concentrations. This is a strong indication that anaerobic biodegradation of the BTEX compounds by methanogenesis is occurring at the site.

Background concentrations of methane at wells and monitoring points located outside or below areas with known BTEX contamination appear to be below 1.0 mg/L. Samples collected from monitoring wells or points located near the contaminant source area contain the highest methane concentrations. In these locations, methane concentrations range from about 1.63 to 14.59 mg/L (March 1994). The highest methane concentration observed at the site in March 1994 was in CPT-02S. The observed distribution of methane in groundwater suggests that methanogenesis may be contributing to BTEX removal in the area of highest BTEX concentrations and as far downgradient as CPT-04. This is consistent with other electron acceptor and redox potential data for this site.

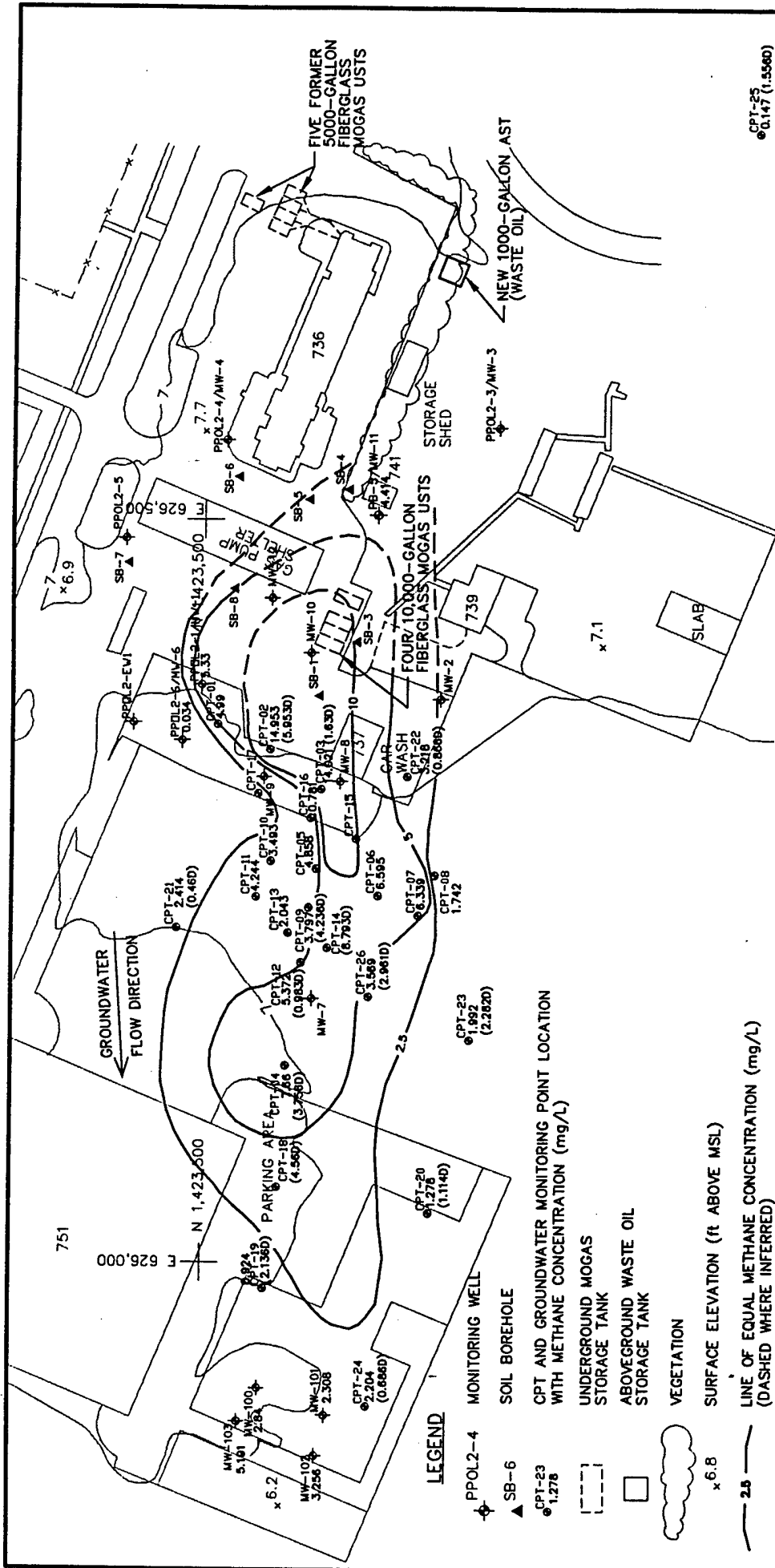

FIGURE 4.10

METHANE ISOPLETH MAP FOR GROUNDWATER MARCH 1994

Site ST-29
 Intrinsic Remediation TS
 Patrick Air Force Base, Florida

PARSONS ENGINEERING SCIENCE, INC.
 Denver, Colorado

Scale: 0 40 80 FEET

North Arrow

- LEGEND**
- PPOL-2-4 MONITORING WELL
 - SB-6 SOIL BOREHOLE
 - CPT-23 WITH METHANE CONCENTRATION (mg/L)
 - UNDERGROUND MORGAS STORAGE TANK
 - ABOVEGROUND WASTE OIL STORAGE TANK
 - VEGETATION
 - 6.8 SURFACE ELEVATION (ft ABOVE MSL)
 - 2.5 LINE OF EQUAL METHANE CONCENTRATION (mg/L) (DASHED WHERE INFERRERD)
 - CONTOUR INTERVAL = VARIABLE
- NOTES**
1. ALL TANK AND WELL LOCATIONS ARE APPROXIMATE.
 2. "D" INDICATES READING FROM DEEPER WELL OF A NEST.
 3. WHERE VALUES FROM DIFFERENT DEPTHS DIFFER, THE FROM THE DEPTH VALUE CORRESPONDING WITH THE HIGHEST TOTAL BTEX CONCENTRATION WAS USED TO GENERATE CONTOURS.

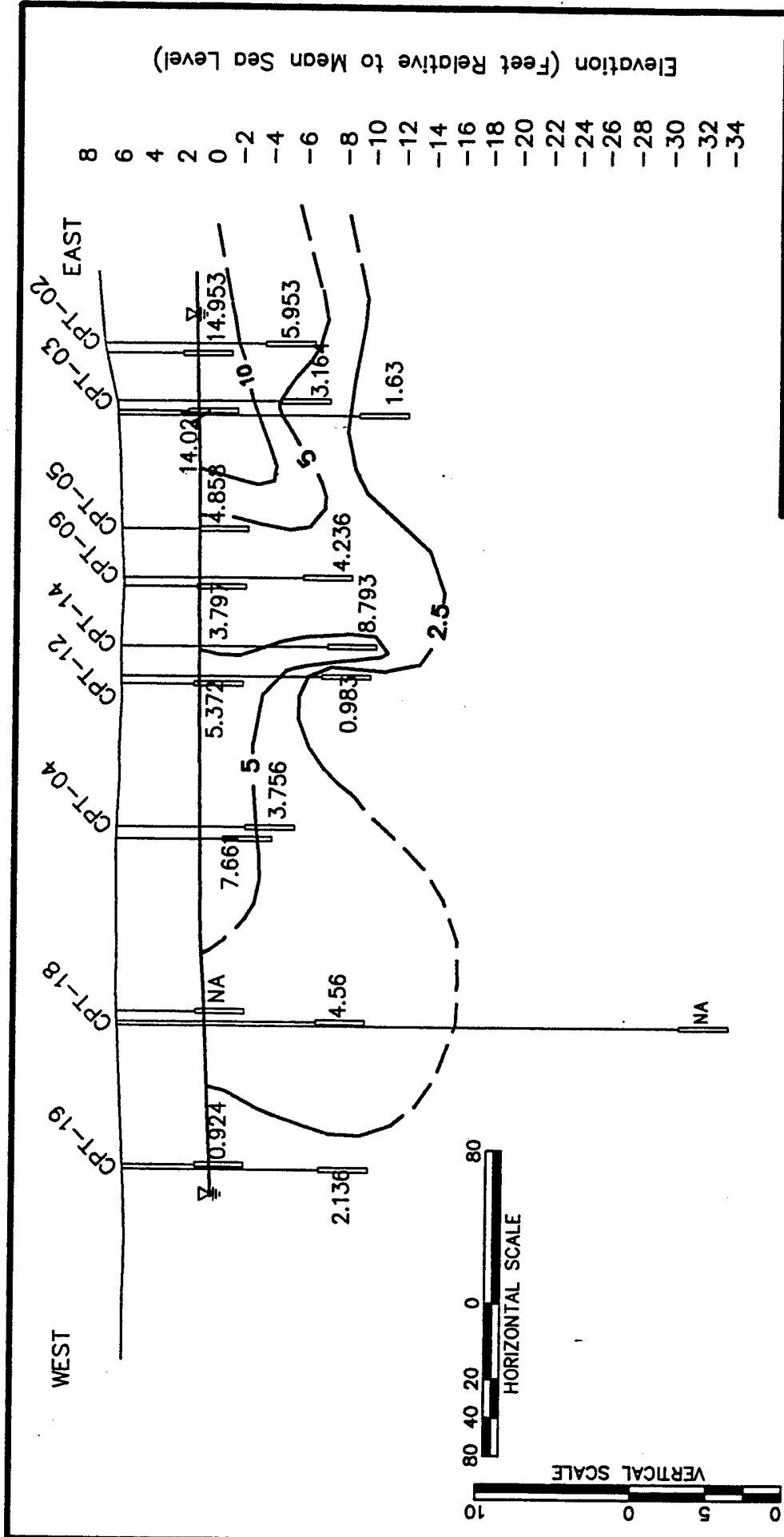
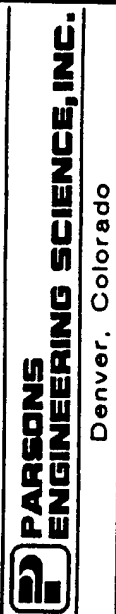

FIGURE 4.11
VERTICAL PROFILE OF METHANE ISOPLETHS FOR GROUNDWATER FOR MARCH 1994
 Site St-29
 Intrinsic Remediation TS
 Patrick Air Force Base, Florida



LEGEND

- ∇ APPROXIMATE GROUNDWATER SURFACE
- || 3.756 WELL OR MONITORING POINT, WITH SCREENED INTERVAL AND METHANE CONCENTRATION (mg/L)
- NA DATA NOT AVAILABLE
- 5 LINE OF EQUAL METHANE CONCENTRATION (mg/L) (DASHED WHERE INFERRED)

The following equations describe the overall stoichiometry of benzene oxidation by methanogenesis. In the absence of microbial cell production, the mineralization of benzene is given by:

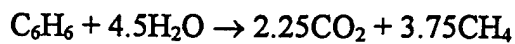

The mass ratio of methane produced during respiration to benzene degraded can be calculated and is given by:

Molecular weights:	Benzene	$6(12) + 6(1) = 78$ gm/mole
	Methane	$3.75(16) = 60$ gm/mole

$$\text{Mass ratio of methane to benzene} = 60/78 = 0.77:1$$

Therefore, 0.77 mg of methane is produced during mineralization of 1 mg of benzene.

Similar calculations can be completed for toluene (0.78 mg of methane produced during mineralization of 1 mg of toluene), ethylbenzene (0.79 mg of methane produced during mineralization of 1 mg of ethylbenzene), and the xylenes (0.79 mg of methane produced during mineralization of 1 mg of xylene). The average mass ratio of methane produced during total BTEX mineralization is thus 0.78:1. This means that approximately 1 mg of BTEX is mineralized for every 0.78 mg of methane produced. The highest measured methane concentration in March 1994 was 14.59 mg/L. With background concentrations as high as 1.0 mg/L, the shallow groundwater at this site has the capacity to assimilate up to 17.4 mg/L (17,400 µg/L) of total BTEX during methanogenesis. Again, this is a conservative estimate of the assimilative capacity of methanogenesis because microbial cell mass production is not taken into account by the stoichiometry shown above (see Section 4.3.3.1). In addition, these calculations are based on observed methane concentrations and not on the amount of carbon dioxide available in the aquifer. Therefore, methanogenic assimilative capacity could be much higher.

4.3.3.6 Reduction/Oxidation Potential

Redox potentials were measured at groundwater monitoring points and at existing monitoring wells in March 1994. Redox potential is a measure of the relative tendency of a solution to accept or transfer electrons. The redox potential of a groundwater system depends on which electron acceptor is being reduced by microbes during BTEX oxidation. The redox potential at Site ST-29 ranges from 54 millivolts (mV) to -293 mV. Table 4.5

summarizes available redox potential data for March 1994. Redox potentials were measured at select groundwater monitoring points in March 1995. Table 4.6 summarizes available redox potential data for March 1995. Figure 4.12 is a map that graphically illustrates the distribution of redox potentials. Redox is decreased to values below -200 mV in the vicinity of CPT-03, CPT-06, CPT-09, CPT-14, CPT-26, and CPT-07 in March 1994. As expected, areas at the site with low redox potentials appear to coincide with areas of high BTEX contamination, low DO, slightly elevated ferrous iron concentrations, and elevated methane concentrations (compare Figures 4.2, 4.4, 4.9, 4.10, and 4.12).

4.3.3.7 Alkalinity

Total alkalinity (as calcium carbonate) was measured at groundwater monitoring points and existing monitoring wells in March 1994. These measurements are summarized in Table 4.5. Total alkalinity (as calcium carbonate) also was measured at select groundwater monitoring points in March 1995. These measurements are summarized in Table 4.6. Alkalinity is a measure of a groundwater's ability to buffer changes in pH caused by the addition of biologically generated acids. Total alkalinity at the site is in the low to moderate range for groundwater, and varies from 148 mg/L at CPT-24S to 520 mg/L at CPT-03S (March 1994). This amount of alkalinity should be sufficient to buffer potential changes in pH caused by biologically mediated BTEX oxidation reactions.

4.3.3.8 pH

pH was measured at groundwater monitoring points and existing monitoring wells in March 1994. These measurements are summarized in Table 4.5. pH was measured at select groundwater monitoring points in March 1995. These measurements are summarized in Table 4.6. The pH of a solution is the negative logarithm of the hydrogen ion concentration $[H^+]$. Groundwater pH at Site ST-29 ranges from 6.7 to 7.6 (March 1994). The majority of groundwater samples had a pH of 7.1 to 7.3 (March 1994). This range of pH is within the optimal range for BTEX-degrading microbes.

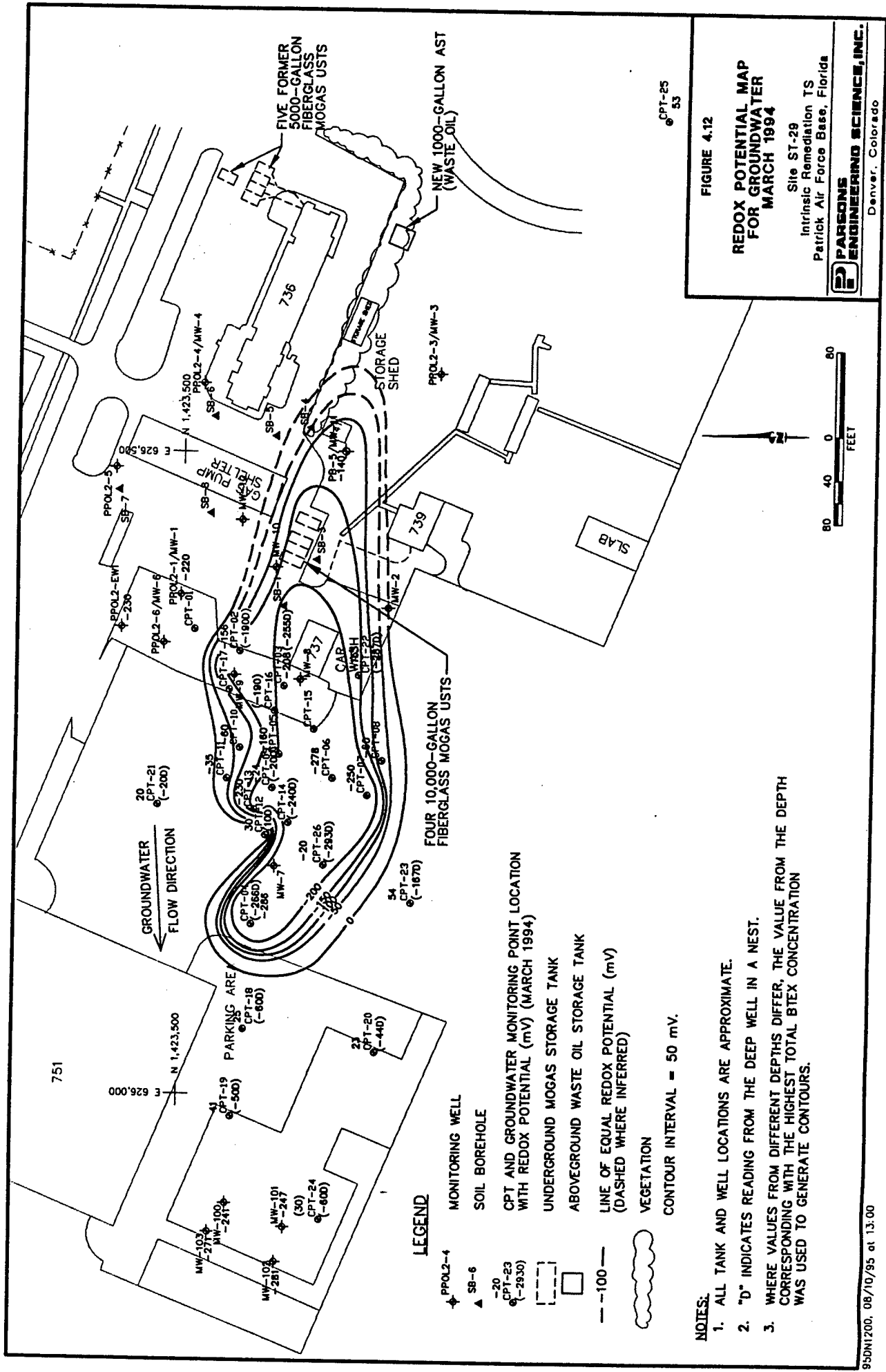
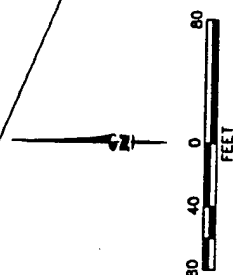

FIGURE 4.12
REDOX POTENTIAL MAP
FOR GROUNDWATER
MARCH 1994
 Site ST-29
 Intrinsic Remediation TS
 Patrick Air Force Base, Florida
PARSONS
ENGINEERING SCIENCES, INC.
 Denver, Colorado



LEGEND

- ▲ PPOL2-4 MONITORING WELL
- ▲ SB-6 SOIL BOREHOLE
- CPT AND GROUNDWATER MONITORING POINT LOCATION WITH REDOX POTENTIAL (mV) (MARCH 1994)
- UNDERGROUND MOGAS STORAGE TANK
- ABOVEGROUND WASTE OIL STORAGE TANK
- LINE OF EQUAL REDOX POTENTIAL (mV) (DASHED WHERE INFERRED)
- ☁ VEGETATION
- CONTOUR INTERVAL = 50 mV.

- NOTES:**
1. ALL TANK AND WELL LOCATIONS ARE APPROXIMATE.
 2. "D" INDICATES READING FROM THE DEEP WELL IN A NEST.
 3. WHERE VALUES FROM DIFFERENT DEPTHS DIFFER, THE VALUE FROM THE DEPTH CORRESPONDING WITH THE HIGHEST TOTAL BTEX CONCENTRATION WAS USED TO GENERATE CONTOURS.

4.3.3.9 Temperature

Groundwater temperature was measured at groundwater monitoring points and existing monitoring wells in March 1994. Table 4.5 summarizes groundwater temperature readings in March 1994. Groundwater temperature also was measured at select groundwater monitoring points in March 1995. Table 4.6 summarizes groundwater temperature readings in March 1995. Temperature affects the types and growth rates of bacteria that can be supported in the groundwater environment, with higher temperatures generally resulting in higher growth rates. Temperatures in the shallow saturated zone varied from 24.7 degrees Celsius (°C) to 27.8°C. These are relatively high temperatures for shallow groundwater, suggesting that bacterial growth rates could be high.

4.3.3 Expressed Assimilative Capacity

The data presented in the preceding sections suggest that mineralization of BTEX compounds is occurring through the microbially mediated processes of aerobic respiration, iron reduction, and methanogenesis. Based on the stoichiometry presented in these sections, the expressed BTEX assimilative capacity of groundwater at Site ST-29 is at least 18,690 µg/L (March 1994, Table 4.7). The calculations presented in these earlier sections are conservative because they do not account for microbial cell mass production. In addition, the measured concentrations of ferrous iron and methane may not be the maximum achievable. The highest plausible dissolved total BTEX concentration observed at the site in March 1994 was 7,304 µg/L in monitoring point CPT-03S. In March 1995, the highest observed total dissolved BTEX concentration was 14,096 µg/L.

Based on the calculations presented in the preceding sections, and on site observations, groundwater at Site ST-29 has more than sufficient assimilative capacity to degrade dissolved BTEX that partitions from the residual phase into the groundwater before the plume migrates 1,200 feet downgradient from the source area.

TABLE 4.7
EXPRESSED ASSIMILATIVE CAPACITY OF SITE GROUNDWATER
MARCH 1994
SITE ST-29 INTRINSIC REMEDIATION TS
PATRICK AFB, FLORIDA

Electron Acceptor or Process	Expressed BTEX Assimilative Capacity (µg/L)
Dissolved Oxygen	1,200
Ferric Hydroxide	90
Methanogenesis	17,400
Expressed Assimilative Capacity	18,690
Highest observed Total BTEX Concentration	7,304

4.4 DIRECT MICROBIOLOGICAL EVIDENCE OF BTEX BIODEGRADATION

USEPA researchers collected groundwater samples for volatile fatty acids (VFAs) analysis in March 1995 at monitoring points CPT-09D, CPT-3M, and CPT-2S. All of these sample locations are within the dissolved BTEX plume. This test is a gas chromatography/mass spectrometry (GC/MS) method wherein the samples are compared to a standard mixture containing a total of 58 phenols, aliphatic acids, and aromatic acids.

During biodegradation of BTEX compounds, VFAs are produced as metabolic byproducts. The production of these VFAs is a direct indication that biodegradation of BTEX compounds is occurring. Table 4.8 shows that propanoic acid, 2-methylpropanoic acid, trimethyl acetic acid, butyric acid, 3,3-dimethylbutyric acid, pentanoic acid, hexanoic acid, 2-ethylhexanoic acid, m-tolylacetic acid, 2,6-dimethylbenzoic acid, 2,5-dimethylbenzoic acid, 3,5-dimethylbenzoic acid, 2,4,6-trimethylbenzoic acid, and 2,4,5-trimethylbenzoic acid all are present in groundwater contaminated with BTEX. This provides additional strong evidence that biodegradation of BTEX is occurring at Site ST-29.

TABLE 4.8
VOLATILE FATTY ACIDS IN GROUNDWATER (1995)
SITE ST-29 INTRINSIC REMEDIATION TS
PATRICK AFB, FLORIDA

Compound	Sample Location	CPT-09D	CPT-3M + 2S
	Sample Name	86-MW-9D	86-MW3M + 2S
Propanoic Acid		34	30
2-Methylpropanoic Acid		6	5
Trimethyl Acetic Acid		8	16
Butyric Acid		12	11
2-Methylbutyric Acid		<5	<5
3-Methylbutyric Acid		<5	<5
3,3-Dimethylbutyric Acid		123	11
Pentanoic Acid		7	5
2,3-Dimethylbutyric Acid		<5	<5
2-Ethylbutyric Acid		ND ^a	ND
2-Methylpentanoic Acid		ND	ND
3-Methylpentanoic Acid		<5	<5
4-Methylpentanoic Acid		ND	<5
Hexanoic Acid		19	13
2-Methylhexanoic Acid		ND	ND
Phenol		<5	<5
Cyclopentanecarboxylic Acid		ND	ND
5-Methylhexanoic Acid		ND	ND
o-Cresol		ND	ND
2-Ethylhexanoic Acid		188	117
Heptanoic Acid		<5	<5
m-Cresol		ND	ND
p-Cresol		ND	ND
1-Cyclopentene-1-Carboxylic Acid		ND	ND
o-Ethylphenol		ND	ND
Cyclopentaneacetic Acid		ND	ND
2,6-Dimethylphenol		ND	ND
2,5-Dimethylphenol		ND	<5
Cyclohexanecarboxylic Acid		ND	ND
3-Cyclohexene-1-Carboxylic Acid		ND	ND
2,4-Dimethylphenol		ND	ND
3,5-Dimethylphenol & m-Ethylphenol		ND	ND
Octanoic Acid		<5	<5
2,3-Dimethylphenol		ND	<5
p-Ethylphenol		ND	ND
Benzoic Acid		5	<5
3,4-Dimethylphenol		ND	ND
m-Methylbenzoic Acid		ND	ND
1-Cyclohexene-1-Carboxylic Acid		ND	ND
Cyclohexaneacetic Acid		ND	ND
2-Phenylpropanoic Acid		ND	ND
o-Methylbenzoic Acid		<5	<5
Phenylacetic Acid		<5	<5
m-Tolylacetic Acid		8	6
o-Tolylacetic Acid		ND	10
2,6 -Dimethylbenzoic Acid		13	10
p-Tolylacetic Acid		ND	<5
p-Methylbenzoic Acid		ND	<5
3-Phenylpropanoic Acid		ND	ND
2,5 -Dimethylbenzoic Acid		49	13
Decanoic Acid		<5	<5
2,4 -Dimethylbenzoic Acid		<5	<5
3,5 -Dimethylbenzoic Acid		<5	ND
2,3 -Dimethylbenzoic Acid		16	19
4-Ethylbenzoic Acid		ND	ND
2,4,6-Trimehtylbenzoic Acid		75	122
3,4-Dimethylbenzoic Acid		ND	<5
2,4,5-Trimehtylbenzoic Acid		84	26

All data in parts per billion (ppb).

a/ ND = compound not detected.

SECTION 5

GROUNDWATER MODEL

5.1 GENERAL OVERVIEW AND MODEL DESCRIPTION

In order to help estimate degradation rates for dissolved BTEX compounds at Site ST-29 and to help predict the future migration of these compounds, Parsons ES modeled the fate and transport of the dissolved BTEX plume. The modeling effort had three primary objectives: 1) to predict the future extent and concentration of the dissolved contaminant plume by modeling the combined effects of advection, dispersion, sorption, and biodegradation; 2) to assess the potential for downgradient receptors to be exposed to contaminants at concentrations above levels of regulatory concern; and 3) to provide technical support for the natural attenuation remedial option at post-modeling regulatory negotiations. The model was developed using site-specific data and conservative assumptions about governing physical and chemical processes. Because of the conservative nature of model input, the reduction in contaminant mass caused by natural attenuation is expected to exceed model predictions. This analysis is not intended to represent a baseline assessment of potential risks posed by site contamination.

The Bioplume II code was used to estimate the potential for dissolved BTEX migration and degradation by naturally occurring mechanisms operating at Site ST-29. The Bioplume II model incorporates advection, dispersion, sorption, and biodegradation to simulate contaminant plume migration and degradation. The model is based upon the USGS Method of Characteristics (MOC) two-dimensional (2-D) solute transport model of Konikow and Bredehoeft (1978). The model was modified by researchers at Rice University to include a biodegradation component that is activated by a superimposed DO plume. Based on the work of Borden and Bedient (1986), the model assumes a reaction between the DO and BTEX that is instantaneous relative to the advective groundwater velocity. Bioplume II solves the USGS 2-D solute transport equation twice, once for hydrocarbon concentrations in the aquifer and once for a DO plume. The two plumes are combined using superposition at every particle move to simulate the instantaneous, biologically-mediated, reaction between hydrocarbons and oxygen.

In recent years it has become apparent that anaerobic processes such as nitrate reduction (denitrification), iron reduction, sulfate reduction, and methanogenesis can be important BTEX degradation mechanisms (Grbic'-Galic', 1990; Beller *et al.*, 1992; Edwards *et al.*, 1992; Edwards and Grbic'-Galic', 1992, Grbic'-Galic' and Vogel, 1987; Lovely *et al.*, 1989; Hutchins, 1991). Although there is evidence that anaerobic biodegradation of fuel hydrocarbons is occurring at Site ST-29, these processes were not accounted for during the modeling. Limiting the simulation to oxygen-limited degradation is a conservative assumption intended to prevent overestimation of degradation rates. The following subsections discuss in more detail the model setup, input parameters and assumptions, model calibration, and simulation results.

5.2 CONCEPTUAL MODEL DESIGN AND ASSUMPTIONS

Prior to developing a groundwater model, it is important to determine if sufficient data are available to provide a reasonable estimate of aquifer conditions. In addition, it is important to ensure that any limiting assumptions can be justified. The most important assumption made when using the Bioplume II model is that oxygen-limited biodegradation is occurring at the site. The Bioplume II model assumes that the limiting factors for biodegradation are: 1) the presence of an indigenous hydrocarbon degrading microbial population, and 2) sufficient background electron acceptor concentrations. Data and information presented in Sections 3 and 4 suggest that oxygen, ferric hydroxide, and carbon dioxide (methanogenesis) are being used as electron acceptors for aerobic and anaerobic biodegradation at Site ST-29. To be conservative, only oxygen was considered as an electron acceptor in the Bioplume II model presented herein. To model biodegradation of BTEX with DO as an electron acceptor, the isopleth maps for these compounds were superimposed on the model grid. Data from this map then were used for model input.

Based on the data presented in Section 3, the shallow saturated zone was conceptualized and modeled as a shallow unconfined aquifer comprised of fine to coarse sand with some gravel or shell fragments (Figures 3.3 and 3.4). The use of a 2-D model is appropriate at Site ST-29 because the saturated interval is relatively homogenous and water level data indicate that the local flow system as defined by horizontal and vertical gradients will likely prevent significant vertical migration of dissolved contamination.

Bioventing has been implemented in the area of greatest soil contamination (north of the car wash). Bioventing will further reduce the residual LNAPL which is the source of continuing dissolved BTEX contamination at the site. After calibration, one of the predictive contaminant fate and transport simulations assumed BTEX source reduction as a result of bioventing.

5.3 INITIAL MODEL SETUP

Where possible, the initial setup for this model was based on existing site data. Where site-specific data were not available, reasonable assumptions for the types of materials comprising the shallow saturated zone were made based on widely accepted literature values. The following sections describe the basic model setup. Those Bioplume II model parameters that were varied during model calibration are discussed in Section 5.4.

5.3.1 Grid Design and Boundary Conditions

The maximum grid size for the Bioplume II model is limited to 20 columns by 30 rows. The dimension of each column and row can range from 0.1 to 999.9 feet. A 20- by 30-cell grid was used to model the Patrick AFB site. Each grid cell was 100 feet long by 50 feet wide. The grid was oriented so that the longest dimension was parallel to the overall direction of groundwater flow. The model grid covers an area of 3 million square feet, or approximately 69 acres. The full extent of the model grid is indicated on Figure 5.1.

Model boundaries are mathematical statements that represent hydrogeologic boundaries, such as areas of specified head (e.g., surface water bodies or contour lines of constant hydraulic head) or specified flux. Hydrogeologic boundaries are represented by three mathematical statements that describe the hydraulic head at the model boundaries. These include:

- 1) Specified-head boundaries (Dirichlet condition) for which the head is determined as a function of location and time only. Surface water bodies exhibit constant head conditions. Specified-head boundaries are expressed mathematically as:

$$\text{Head} = f(x, y, z, t)$$

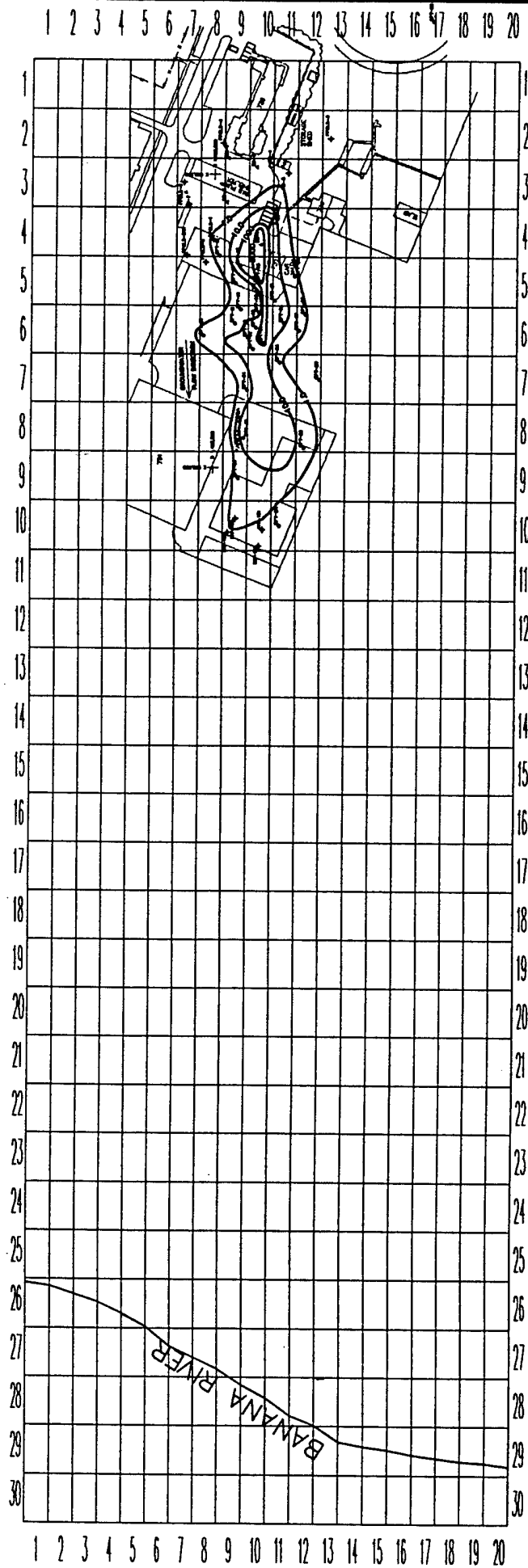

GRID SIZE: 100 x 50 FEET
NOT TO SCALE

FIGURE 5.1

MODEL GRID

Site ST-29
Intrinsic Remediation TS
Patrick Air Force Base, Florida

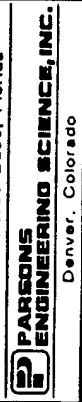

- LEGEND:
- ◆ PPO2-4 MONITORING WELL
 - ▲ SB-6 SOIL BOREHOLE
 - CPT-22 CPT AND GROUNDWATER MONITORING POINT LOCATION
 - 10 LINE OF EQUAL TOTAL BIEX CONCENTRATION (µg/L)
 - VARIABLE CONTOUR INTERVAL = VARIABLE

- 2) Specified-flow boundaries (Neumann conditions) for which the mathematical description of the flux across the boundary is given. The flux is defined as a volumetric flow rate per unit area (e.g., ft³/ft²/day). No-flow boundaries are a special type of specified-flow boundary and are set by specifying the flux to be zero. Examples of no-flow boundaries include groundwater divides and impermeable hydrostratigraphic units. Specific-flux boundaries are expressed mathematically as:

$$Flux = f(x, y, z, t)$$

- 3) Head-dependent flow boundaries (Cauchy or mixed-boundary conditions) where the flux across the boundary is calculated from a given boundary head value. This type of flow boundary is sometimes referred to as a mixed-boundary condition because it is a combination of a specified-head boundary and a specified-flow boundary. Head-dependent flow boundaries are used to model leakage across semipermeable boundaries. Head-dependent flow boundaries are expressed mathematically as (Bear, 1979):

$$Flux = \frac{(H_0 - H)K}{B'}$$

- Where:
- H = Head in the zone being modeled (generally the zone containing the contaminant plume)
 - H₀ = Head in external zone (separated from plume by semipermeable layer)
 - K' = Hydraulic conductivity of semipermeable layer
 - B' = Thickness of semipermeable layer

Natural hydraulic boundaries are modeled using a combination of the three types of model boundary conditions listed above. When possible, hydrologic boundaries such as surface water bodies, groundwater divides, contour lines, or hydrologic barriers should coincide with the perimeter of the model. In areas lacking obvious hydrologic boundaries, specified-head or specified-flux boundaries can be specified at the model perimeter if the boundaries are far enough removed from the contaminant plume that transport calculations are not affected. Bioplume II requires the entire model domain to be bounded by zero-flux cells (also known as no-flow cells), with other boundary conditions established within the subdomain specified by the no-flow cells.

Specified-head boundaries for the model were set on the eastern and western perimeter of the model grid to simulate the westward flow of groundwater observed at the site. The eastern boundary was set in the approximate location of the groundwater divide indicated by water level data. The head of this boundary was estimated to be 2.3 to 2.4 feet above msl. The western model boundary was defined by the eastern bank of the Banana River, which runs north-northeast along the western edge of the Base. The head of the river was assumed to be 0.1 foot above msl. These constant-head cells were placed far enough away from the BTEX plume to avoid potential boundary interferences.

The northern and southern model boundaries were left as no-flow boundaries. In this case, the flux through these boundaries is assumed to be zero because flow is parallel to these boundaries. The base, or lower, boundary of the model is also assumed to be no-flow. The upper model boundary is defined by the simulated water table surface.

5.3.2 Groundwater Elevation and Gradient

The 1994 water table elevation map presented in Figure 3.5 was used to define the starting heads input into the Bioplume II model. Groundwater flow in the vicinity of Site ST-29 is to the west with an average gradient of approximately 0.002 ft/ft between monitoring points CPT-03 and CPT-24. It is likely that the gradient diminishes to the west; if the observed gradient (0.002 ft/ft) extended all the way to the Banana River (approximately 2,000 feet west of CPT-24), the water table would be 2 to 3 feet below msl. No data are available to quantify seasonal variations in groundwater flow direction or gradient at the site; it was assumed that the observed water levels were representative of steady-state conditions. As described in Section 5.4.1, the model was calibrated to the observed water table.

The area of study is effectively isolated from any tidal influences. A groundwater divide is present just east of the site is between the modeled area and the Atlantic Ocean. In addition, there are no measurable tides along the Banana River which is located on the same side of the groundwater divide as the ST-29 BTEX plume (this is indicated on the USGS topographic maps for the site and vicinity). Furthermore, a study by Bredehoeft (1967) indicates that tides have a minor influence on groundwater levels, producing fluctuations on the order of 1 to 2 centimeters, even in areas with significant (3 feet or greater) tidal fluctuations.

5.3.3 BTEX Concentrations

The total dissolved BTEX concentrations obtained from 1994 laboratory analytical data for each CPT and well location were used for model development (Table 4.3). At CPT nests, the highest BTEX concentration from all monitoring points at that location was used. The observed BTEX plume covers an area of approximately 90,000 square feet (2 acres). The shape and distribution of the total BTEX plume is the result of advective-dispersive transport and biodegradation of dissolved BTEX contamination. As described in Section 5.4.2, the simulated BTEX plume was calibrated to match the observed BTEX plume.

5.3.4 Dissolved Oxygen

As discussed previously, the Bioplume II model assumes an instantaneous reaction between the BTEX plume and the DO plume. The discussion presented in Section 4 suggests that DO, ferric iron, and carbon dioxide (for methanogenesis) are being used as electron acceptors for biodegradation of BTEX compounds at Site ST-29. To be conservative, the total BTEX plume at Site ST-29 was modeled assuming that DO was the only electron acceptor being utilized for the biodegradation of the BTEX compounds.

Groundwater samples collected in uncontaminated portions of the aquifer suggest that background DO concentrations at the site are as high as 3.7 mg/L. To be conservative, background oxygen concentrations were assumed to be 3.5 mg/L for Bioplume II model development. Table 4.4 contains DO data for the site. Figures 4.4 and 4.5 are DO isopleth maps.

The upgradient constant-head cells in the Bioplume II model require background electron acceptor concentrations to be input as constant concentrations to simulate incoming electron acceptors. A DO concentration of 3.5 mg/L (as measured at crossgradient point CPT-25) was used for these cells.

5.4 MODEL CALIBRATION

Model calibration is an important component in the development of any numerical groundwater model. Calibration of the flow model demonstrates that the model is capable of matching hydraulic conditions observed at the site; calibration of a contaminant transport model superimposed upon the calibrated flow model helps verify that

contaminant loading and transport conditions are being appropriately simulated. The numerical flow model presented herein was calibrated by altering transmissivity in a trial-and-error fashion until simulated heads approximated observed field values within a prescribed accuracy. After calibration of the flow model, the numerical transport model was calibrated by altering hydraulic parameters, transport parameters, and stresses (i.e., injection wells and their contaminant loading rates) in a trial-and-error fashion until the simulated BTEX plume approximated observed field values. Table 5.1 lists input parameters used for the modeling effort. Model input and output is included in Appendices C and D, respectively.

5.4.1 Water Table Calibration

The shallow water table at Site ST-29 was assumed to be influenced only by continuous recharge and discharge at the constant-head cells established at the upgradient and downgradient model boundaries. Recharge of the aquifer through rainfall was not included in the model. This is considered appropriate because a large portion of the contaminated area is covered by concrete. Potential recharge from other sources was omitted because of a lack of reliable data. Only the initial water levels at the constant-head cells and the transmissivity were varied to calibrate the water table surface. The model was calibrated under steady-state conditions.

Hydraulic conductivity is an important aquifer characteristic that determines the ability of the water-bearing strata to transmit groundwater. Transmissivity is the product of the hydraulic conductivity and the thickness of the aquifer. An accurate estimate of hydraulic conductivity is important to help quantify advective groundwater flow velocities and to define the flushing potential of the aquifer and the quantity of electron-acceptor-charged groundwater that is entering the site from upgradient locations. Based on the work of Rifai *et al.* (1988), the Bioplume II model is particularly sensitive to variations in hydraulic conductivity. Lower values of hydraulic conductivity result in a slower-moving plume that degrades at a slower rate because less oxygen, nitrate, iron, sulfate, and carbon dioxide are available for biodegradation. Higher values of hydraulic conductivity result in a faster moving plume that degrades faster because more electron acceptors are available for biodegradation.

TABLE 5.1
BIOPLUME II MODEL INPUT PARAMETERS
SITE ST-29 INTRINSIC REMEDIATION TS
PATRICK AFB, FLORIDA

Parameter	Description	Calibrated Model Setup	PATC	PATD
NTIM	Maximum number of time steps in a pumping period	8	58	34
NPMP	Number of Pumping Periods	1	1	4
NX	Number of nodes in the X direction	20	20	20
NY	Number of nodes in the Y direction	30	30	30
NPMAX	Maximum number of Particles $NPMAX=(NX-2)(NY-2)(NPTPND) + (Ns^*) (NPTPND) + 250$	5250	5250	5250
NPNT	Time step interval for printing data	1	1	1
NITP	Number of iteration parameters	7	7	7
NUMOBS	Number of observation points	0	0	0
ITMAX	Maximum allowable number of iterations in ADIP ^w	200	200	200
NREC	Number of pumping or injection wells	5	5	5
NPTPND	Initial number of particles per node	9	9	9
NCODES	Number of node identification codes	3	3	3
NPNTMV	Particle movement interval (IMOV)	0	0	0
NPNTVL	Option for printing computed velocities	2	2	2
NPNTD	Option to print computed dispersion equation coefficients	2	0	0
NPDEL	Option to print computed changes in concentration	0	0	0
NPNCHV	Option to punch velocity data	0	0	0
NREACT	Option for biodegradation, retardation and decay	1	1	1
PINT	Pumping period (years)	8	58	8,1,1,25
TOL	Convergence criteria in ADIP	0.001	0.001	0.001
POROS	Effective porosity	0.35	0.35	0.35
BETA	Characteristic length (long. dispersivity; feet)	20	20	20
S	Storage Coefficient	0 (Steady-State)	0	0
TIMX	Time increment multiplier for transient flow	-	-	-
TINIT	Size of initial time step (seconds)	-	-	-
XDEL	Width of finite difference cell in the x direction (feet)	50	50	50
YDEL	Width of finite difference cell in the y direction (feet)	100	100	100
DLTRAT	Ratio of transverse to longitudinal dispersivity	0.3	0.3	0.3
CELDIS	Maximum cell distance per particle move	0.5	0.5	0.5
ANFCTR	Ratio of T_{yy} to T_{xx} (1 = isotropic)	1	1	1
DK	Distribution coefficient	0.35	0.35	0.35
RHOB	Bulk density of the solid (grams/cubic centimeter)	1.6	1.6	1.6
THALF	Half-life of the solute	-	-	-
DEC1	Anaerobic decay coefficient	0	0	0
DEC2	Reaeration coefficient (day ⁻¹)	0.0009	0.0009	0.0009
F	Stoichiometric Ratio of HC to Oxygen	3.1	3.1	3.1

^{*w} Ns = Number Of Nodes That Represent Fluid Sources (Wells or Constant Head Cells)

^w ADIP = Alternating-Direction Implicit Procedure (subroutine for solving groundwater flow equation)

Saturated thickness data from previous reports, CPT logs, and water level measurements were used in conjunction with the average hydraulic conductivity as determined from slug tests (0.052 ft/min) to estimate an initial uniform transmissivity for the entire model domain. Based on slug tests performed at the site, hydraulic conductivity varies from 9.6×10^{-3} ft/min to 8.9×10^{-2} ft/min and is within the accepted range for sandy materials (Freeze and Cherry, 1979). To better match heads in the model to observed

values, the transmissivities were progressively varied in blocks and rows until the simulated water levels for cells corresponding to the selected well locations matched the observed water levels as closely as possible. Figure 5.2 shows the calibrated water table. Calibrated model hydraulic conductivities ranged from 3.0×10^{-2} ft/min to 0.14 ft/min (5.0×10^{-4} feet per second (ft/sec) to 2.3×10^{-3} ft/sec).

Water level elevation data from eight monitoring well and monitoring point locations were used to compare measured and simulated heads for calibration. The eight selected locations were: CPT-03, CPT-04, CPT-18, CPT-21, CPT-22, CPT-23, CPT-24, and PPOL2-1.

The root mean squared (RMS) error is commonly used to express the average difference between simulated and measured heads. RMS error is the average of the squared differences between measured and simulated heads, and can be expressed as:

$$\text{RMS} = \left[\frac{1}{n} \sum_{i=1}^n (h_m - h_s)_i^2 \right]^{0.5}$$

Where: n = the number of points where heads are being compared
 h_m = measured head value
 h_s = simulated head value.

The RMS error between observed and calibrated values at the eight comparison points was 0.091 foot, which corresponds to a calibration error of 3.97 percent (water levels dropped 2.3 feet over the length of the model grid). RMS error calculations are summarized in Appendix C. A plot of measured vs. calibrated heads shows a random distribution of points and is also shown in Appendix C. Deviation of points from a straight line should be randomly distributed in a plot of results from computer simulations (Anderson and Woessner, 1992).

In solving the groundwater flow equation, Bioplume II establishes the water table surface and calculates an overall hydraulic balance that accounts for the numerical difference between flux into and out of the system. The hydraulic mass balance for the calibrated model was excellent, with 99.9 percent of the water flux into and out of the system being numerically accounted for (i.e., a 0.1-percent error). According to Anderson and Woessner (1992), a mass balance error of around 1 percent is acceptable, while Konikow (1978) indicates an error of less than 0.1 percent was ideal.

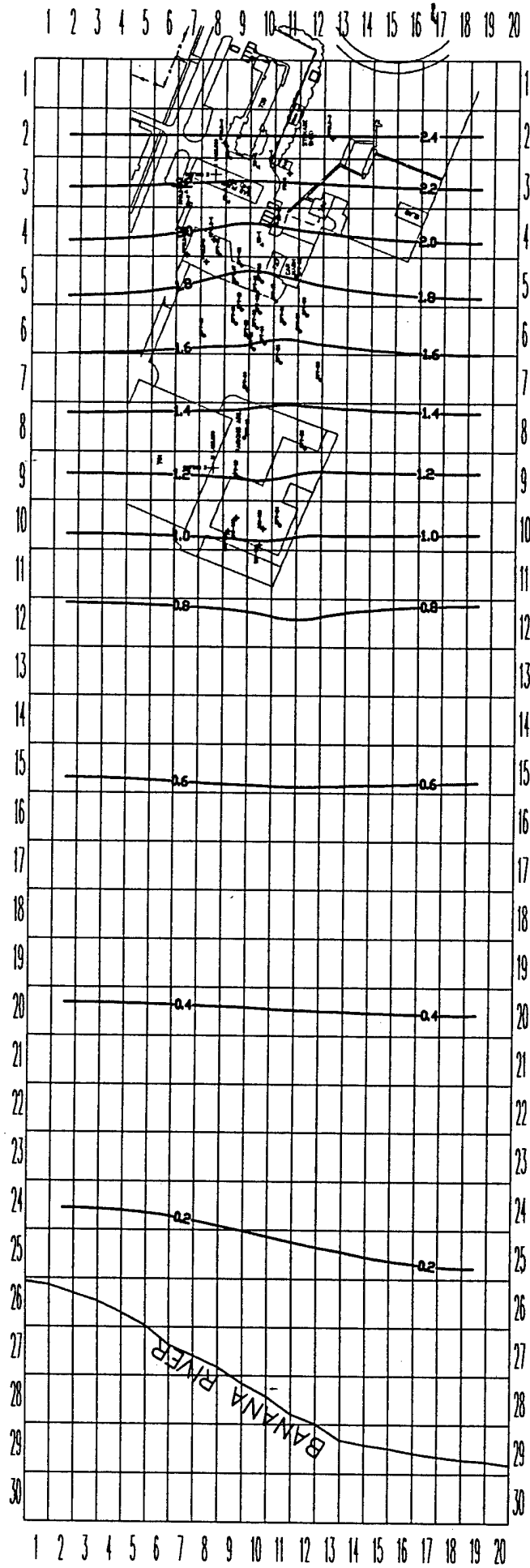

NOT TO SCALE

FIGURE 5.2

CALIBRATED WATER TABLE MAP

Site ST-29
 Intrinsic Remediation TS
 Patrick Air Force Base, Florida



LEGEND:

- PF02-4 (cross symbol) MONITORING WELL
- SB-6 (triangle symbol) SOIL BOREHOLE
- CPT-22 (circle symbol) CPT AND GROUNDWATER MONITORING POINT LOCATION
- (dashed line symbol) LINE OF GROUNDWATER ELEVATION (FEET ABOVE MSL)
- 1.0 (contour line symbol) CONTOUR INTERVAL = 0.2 FOOT

5.4.2 BTEX Plume Calibration

Model input parameters affecting the distribution and concentration of the simulated BTEX plume were modified so that model predictions matched dissolved total BTEX concentrations observed in March 1994. To do this, model runs were made using the calibrated steady-state hydraulic parameters coupled with the introduction of contaminants. For this site, the calibration also involved a time element, because it is known that fuel was released in 1985 or 1986. As a result, the plume calibration simulations were made with a time constraint of 8 years; in other words, computed BTEX plume concentrations and configurations were compared to March 1994 data after 8 years of simulation time incorporating the initial introduction of contaminants into the groundwater.

Because residual LNAPL contamination is present in the vicinity of the water table at the site, it was necessary to include injection wells to simulate partitioning of BTEX compounds from the residual LNAPL into the groundwater. The location of the injection wells is shown on Figure 5.3. Locations of injection wells were based on the extent of soil contamination as indicated on Figure 4.1, the extent of groundwater contamination indicated on Figure 4.2, and the approximate location of the former UST and product line that were known to leak.

While the term "injection well" suggests contaminants are being introduced at a point, Bioplume II assumes that contamination introduced at a well instantly equilibrates throughout the entire cell in which the well is located. The injection rate for the cells was set at 1×10^{-5} ft³/sec, a value low enough so that the flow calibration and water balance were not affected. Relatively high BTEX concentrations were injected in upgradient injection wells because of the low pumping rate and the influx of oxygen introduced at the upgradient constant-head cells. Replenishment of oxygen quickly degraded BTEX concentrations at the head of the plume, which in turn required larger injection concentrations of BTEX to produce observed BTEX contours. It was assumed that the initial DO concentration in the shallow aquifer was uniformly 3.5 mg/L, and that water with that DO concentration would be continually introduced at the eastern grid boundary.

Total BTEX injection concentrations were determined by varying the injection concentration for the various wells from 100 to 1,500 mg/L until the modeled total BTEX plume approximated the total BTEX plume observed in March 1994. By varying the injection well concentrations, the coefficient of retardation, dispersivity, and the

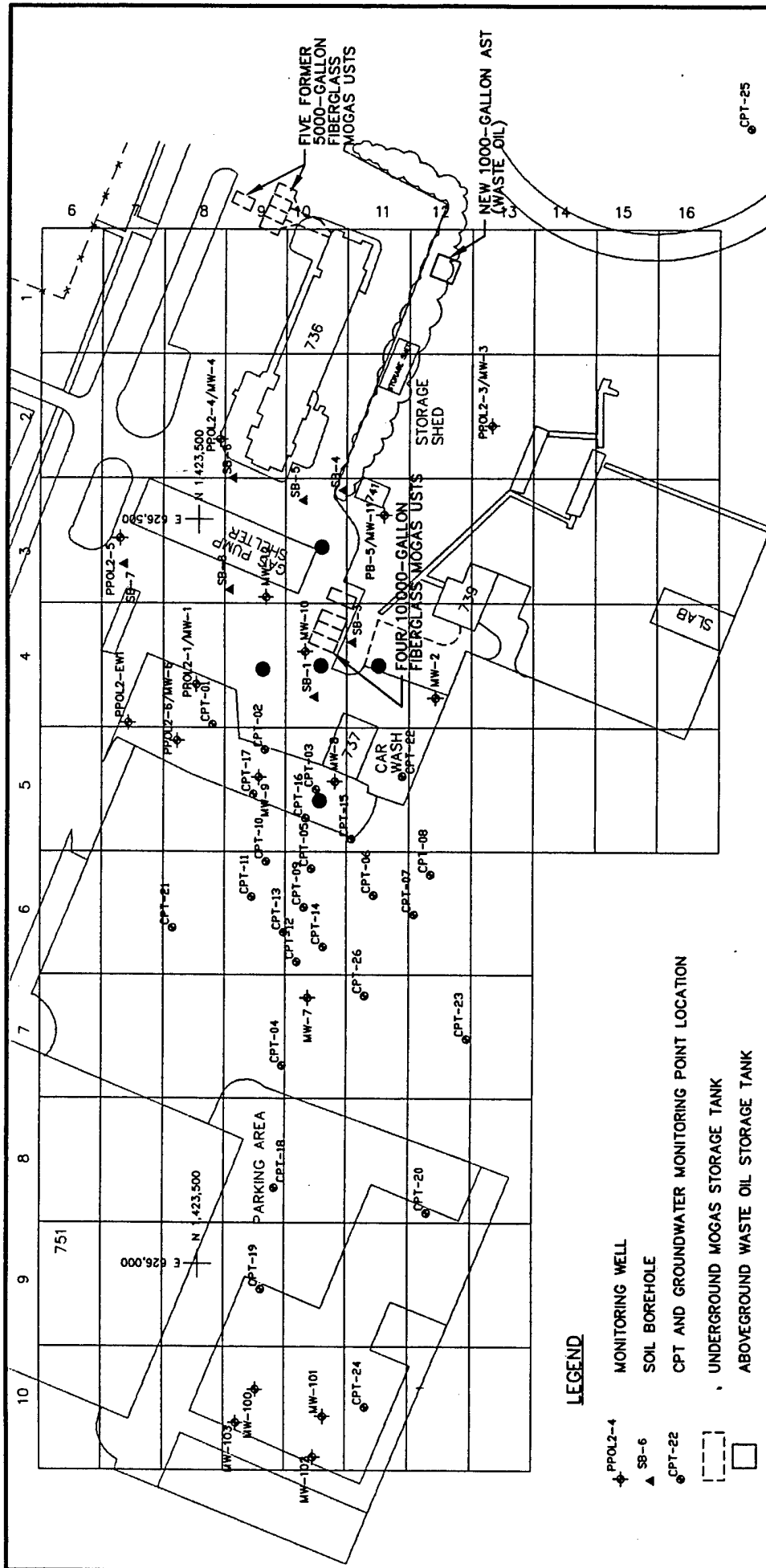

FIGURE 5.3
LOCATION OF SIMULATED INJECTION WELLS FOR MODEL CALIBRATION AND PREDICTION
 Site ST-29
 Intrinsic Remediation TS
 Patrick Air Force Base, Florida
PARSONS ENGINEERING SCIENCE, INC.
 Denver, Colorado

- LEGEND**
- ◆ PPOL2-4 MONITORING WELL
 - ▲ SB-6 SOIL BOREHOLE
 - CPT-22 CPT AND GROUNDWATER MONITORING POINT LOCATION
 - ▭ UNDERGROUND MOGAS STORAGE TANK
 - ▭ ABOVEGROUND WASTE OIL STORAGE TANK
 - LOCATION OF SIMULATED BTEX INJECTION WELL
 - ☁ VEGETATION

NOTE:
 ALL TANK LOCATIONS ARE APPROXIMATE.

reaeration coefficient, the BTEX plume was calibrated reasonably well to the existing plume. The calibrated plume configuration is shown on Figure 5.4.

The calibrated model plume, while not identical to the observed BTEX plume, compares very favorably. The computed plume does not have concentrations as high as the concentration observed at CPT-03 (7,304 $\mu\text{g/L}$), but the area of the computed 3,200- $\mu\text{g/L}$ BTEX contour roughly coincides with the 5,000 $\mu\text{g/L}$ contour interpreted from the observed concentrations. The maximum simulated concentration was 3,500 $\mu\text{g/L}$ for the cell just upgradient from CPT-03. The computed distribution likely represents a similar total mass of BTEX, because the model assumes that contamination extends throughout the total depth of the aquifer, while in reality the plume is only present in a portion of the total aquifer thickness (Figure 4.3). In addition, the horizontal extent of the computed 1,600- $\mu\text{g/L}$ contour compares favorably with the observed 1,000- $\mu\text{g/L}$ contour. Finally, the computed 50- $\mu\text{g/L}$ contour delineates an area similar to the area delineated by the observed 10- $\mu\text{g/L}$ contour. Comparison with the observed 5.0- and 1.0- $\mu\text{g/L}$ contours is not possible because the model output did not include concentrations low enough to allow contouring at a similar level. The apparent discrepancies between observed BTEX concentrations and those predicted by the model result from use of a discretized grid to model a continuous system and from the output of the model, in which simulated reported contaminant concentrations are averages for each entire model cell. Because of the conservative assumptions made in constructing the model and selecting parameters, the model results are conservative and are not likely to underestimate contaminant travel distances.

5.4.2.1 Discussion of Parameters Varied During Plume Calibration

As noted previously, the transport parameters varied during plume calibration were dispersivity, the coefficient of retardation, and the coefficient of reaeration. These parameters were generally varied with the intent of limiting plume migration to the observed extents, because the original estimates for the parameters resulted in a calculated BTEX plume that extended almost twice as far as the observed plume. While these parameters were varied with this common intent, each had a slightly different impact on the size and shape of the simulated plume. BTEX concentrations in the simulated injection wells also were varied, but these parameters had little effect on plume size and shape unless they were too low to permit the plume to migrate beyond the source cells or so high that the simulated concentrations were unrealistic.

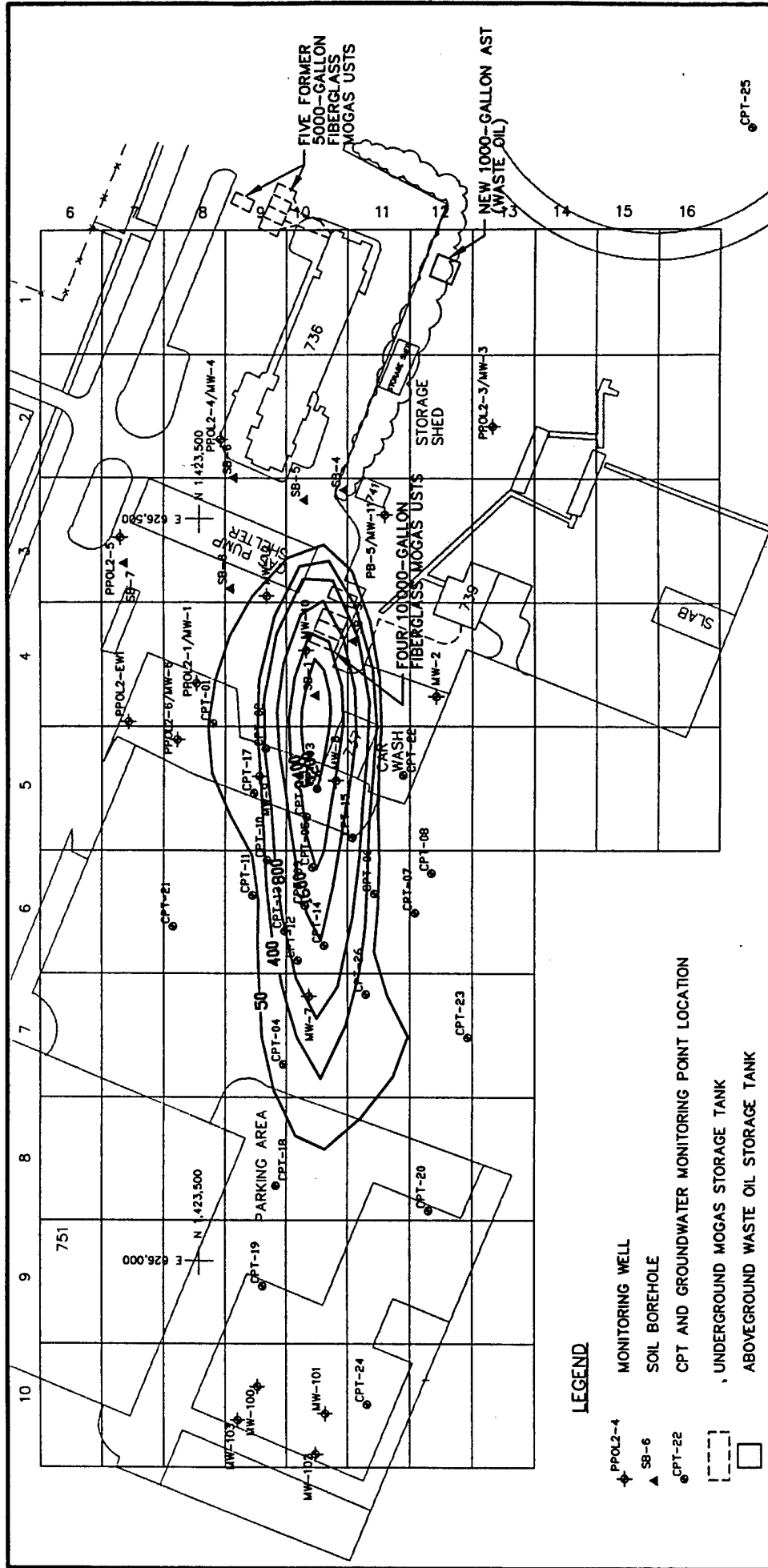

FIGURE 5.4

CALIBRATED BTEX PLUME

Site ST-29
 Intrinsic Remediation TS
 Patrick Air Force Base, Florida

PARSONS ENGINEERING SCIENCE, INC.
 Denver, Colorado

- LEGEND**
- ◆ PPOL2-4 MONITORING WELL
 - ▲ SB-6 SOIL BOREHOLE
 - CPT-22 CPT AND GROUNDWATER MONITORING POINT LOCATION
 - ▭ UNDERGROUND WASTE OIL STORAGE TANK
 - ABOVEGROUND WASTE OIL STORAGE TANK
 - 50— LINE OF EQUAL TOTAL BTEX CONCENTRATION (µg/L)
 - ☁ VEGETATION
 - CONTOUR INTERVAL = VARIABLE
- NOTE:**
 ALL TANK LOCATIONS ARE APPROXIMATE.

5.4.2.1.1 Effective Porosity

Effective porosity plays a significant role in calculations of groundwater velocity, which will in turn affect the simulation of contaminant transport. As noted in Section 3.3.3.3, the effective porosity of the aquifer materials at Site ST-29 was assumed to be 35 percent. This value was not changed during calibration.

5.4.2.1.2 Dispersivity

Much controversy surrounds the concepts of dispersion and dispersivity. Longitudinal dispersivity values for sediments similar to those found at the site range from 0.1 to 200 feet (Walton, 1988). Longitudinal dispersivity was originally estimated as 17 feet, using one-tenth of the distance between the spill source and the longitudinal centroid of the plume. Dispersivity estimation calculations are included in Appendix C. Transverse dispersivity values generally are estimated as one-tenth (0.1) of the longitudinal dispersivity values (Domenico and Schwartz, 1990). The initial model input assumed the same ratio.

During plume calibration, longitudinal dispersivity was increased to 20 feet from the original estimate of 17 feet. In addition, the ratio of transverse dispersivity to longitudinal dispersivity was increased to 0.3 from the original estimate of 0.1. This was done to increase the lateral extent of the plume and to prevent the computed plume from extending too far downgradient, as well as to prevent concentrations in the source cells from being significantly greater than the observed concentrations.

5.4.2.1.3 Coefficient of Retardation

Retardation of the BTEX compounds relative to the advective velocity of the groundwater occurs when BTEX molecules are sorbed to the aquifer matrix. Based on measured TOC concentrations in uncontaminated portions of the shallow saturated zone, and assuming a bulk density of 1.6 grams/cubic centimeter (Freeze and Cherry, 1979), and published values of the soil sorption coefficient (K_{oc}) for the BTEX compounds (as listed in Wiedemeier *et al.*, 1995), the coefficients of retardation for the BTEX compounds were calculated. The results of these calculations are summarized in Table 5.2. To be conservative, the range of coefficients of retardation calculated for benzene (1.09 to 3.02) was used as a constraint for model input. The coefficient of retardation originally input to the model was 1.7. The lower the assumed coefficient of retardation, the farther the BTEX plume will migrate downgradient.

TABLE 5.2

**CALCULATION OF RETARDATION COEFFICIENTS
SITE ST-29 INTRINSIC REMEDIATION TS
PATRICK AFB, FLORIDA**

Compound	K_{oc} (L/kg ^{a/})	Maximum Fraction Organic Carbon ^{b/}	Minimum Fraction Organic Carbon ^{b/}	Average Fraction Organic Carbon ^{b/}	Distribution Coefficient, K_d (L/kg)		Bulk Density (kg/L) ^{d/}	Effective Porosity ^{d/}	Coefficient of Retardation		
					Maximum ^{c/}	Minimum ^{c/}			Maximum	Average	
Benzene	79	0.00558	0.00026	0.00143	0.441	0.021	1.60	0.35	3.02	1.09	1.52
Toluene	190	0.00558	0.00026	0.00143	1.060	0.049	1.60	0.35	5.85	1.23	2.24
Ethylbenzene	468	0.00558	0.00026	0.00143	2.611	0.122	1.60	0.35	12.94	1.56	4.06
m-Xylene	405	0.00558	0.00026	0.00143	2.260	0.105	1.60	0.35	11.33	1.48	3.65
o-Xylene	422	0.00558	0.00026	0.00143	2.355	0.110	1.60	0.35	11.76	1.50	3.76
p-Xylene	357	0.00558	0.00026	0.00143	1.992	0.093	1.60	0.35	10.11	1.42	3.33

NOTES:

^{a/} From technical protocol (Wiedemeier *et al.*, 1995).^{b/} From site data.^{c1/} K_d = Maximum Fraction Organic Carbon x K_{oc} .^{c2/} K_d = Minimum Fraction Organic Carbon x K_{oc} .^{c3/} K_d = Average Fraction Organic Carbon x K_{oc} .^{d/} Literature values.

During plume calibration, the coefficient of retardation was gradually raised from the initial value of 1.7 to a value of 2.6. As with the dispersivity, this variable was altered in response to model predictions of BTEX concentrations extending well beyond the observed limits. In addition, increasing the value of this parameter also was necessary to increase BTEX concentrations near the source area by limiting the travel rate of the contaminants. By limiting the travel rates, the main body of the plume were exposed to a smaller volume of oxygenated water, resulting in higher simulated concentrations. In addition, organic matter was observed in the vicinity of the water table at several locations. This is significant because hydrophobic organic molecules, such as fuel hydrocarbons, will sorb most readily to organic matter.

5.4.2.1.4 Reaeration Coefficient

The reaeration coefficient is a first-order rate constant used by Bioplume II to simulate the replenishment of oxygen into the groundwater by soil gas diffusion and rainwater infiltration. A reaeration coefficient of 0.003 day^{-1} was originally estimated, based on other documented Bioplume modeling efforts (e.g., Rifai *et al.*, 1988).

The reaeration coefficient had a significant effect on limiting plume migration, but was most important in controlling the BTEX concentrations at the fringes of the plume. At its originally estimated value of 0.003 day^{-1} , the plume did not extend more than one cell length beyond the source cells, and computed concentrations all were greater than $150 \mu\text{g/L}$. This coefficient was reduced to 0.0009 day^{-1} , and the calculated plume extent was more realistic, with computed concentrations below $50 \mu\text{g/L}$ allowing better definition of the plume. Reduction of this coefficient also was appropriate because much of the plume area is covered with concrete, limiting infiltration of oxygenated precipitation.

5.5 SENSITIVITY ANALYSIS

The purpose of the sensitivity analysis is to determine the effect of varying model input parameters on model output. Based on the work of Rifai *et al.* (1988), the Bioplume II model is most sensitive to changes in the coefficient of reaeration, the coefficient of anaerobic decay, and the hydraulic conductivity of the media, and is less sensitive to changes in the retardation factor, porosity, and dispersivity. Because the coefficient of anaerobic decay was set to zero, the sensitivity analysis was conducted by varying transmissivity, dispersivity, the coefficient of retardation, and the coefficient of reaeration.

The use of an anaerobic decay coefficient was rejected because only aerobic biodegradation was modeled for this site.

To perform the sensitivity analyses, an individual run of the plume calibration model was made with the same input as the calibrated model, except that one of the aforementioned parameters was varied. The models were run for 8 years, as was the calibrated model, so that the independent effect of each variable could be assessed. As a result, eight sensitivity runs of the calibrated model were made, with the following variations:

- 1) Transmissivity uniformly increased by a factor of 5;
- 2) Transmissivity uniformly decreased by a factor of 5;
- 3) Longitudinal dispersivity increased by a factor of 5;
- 4) Longitudinal dispersivity decreased by a factor of 5;
- 5) Reaeration coefficient increased by a factor of 5;
- 6) Reaeration coefficient decreased by a factor of 5;
- 7) Coefficient of retardation increased by a factor of 1.5; and
- 8) Coefficient of retardation decreased by a factor of 2.

The results of the sensitivity analyses are shown graphically in Figures 5.5, 5.6, 5.7, and 5.8. These figures display the modeled BTEX concentrations versus distance along the centerline of the plume (in the tenth model column). This manner of displaying data is useful because BTEX concentrations are highest in the tenth column, the plume is relatively narrow, and the plume migrates in a direction parallel to the model grid. Furthermore, the figures allow easy visualization of the changes in BTEX concentration caused by varying model input parameters.

The effects of varying transmissivity are shown by Figure 5.5. Uniformly increasing the transmissivity by a factor of five increased the biodegradation rate of the plume such that the maximum concentrations in the source cell area were only about 150 $\mu\text{g/L}$, compared to the observed maximum of 7,403 $\mu\text{g/L}$ and the simulated maximum of 3,500 $\mu\text{g/L}$. In addition, BTEX were only present in the source cells. This results from the greater flux of water through the model area bringing a greater mass of DO into contact

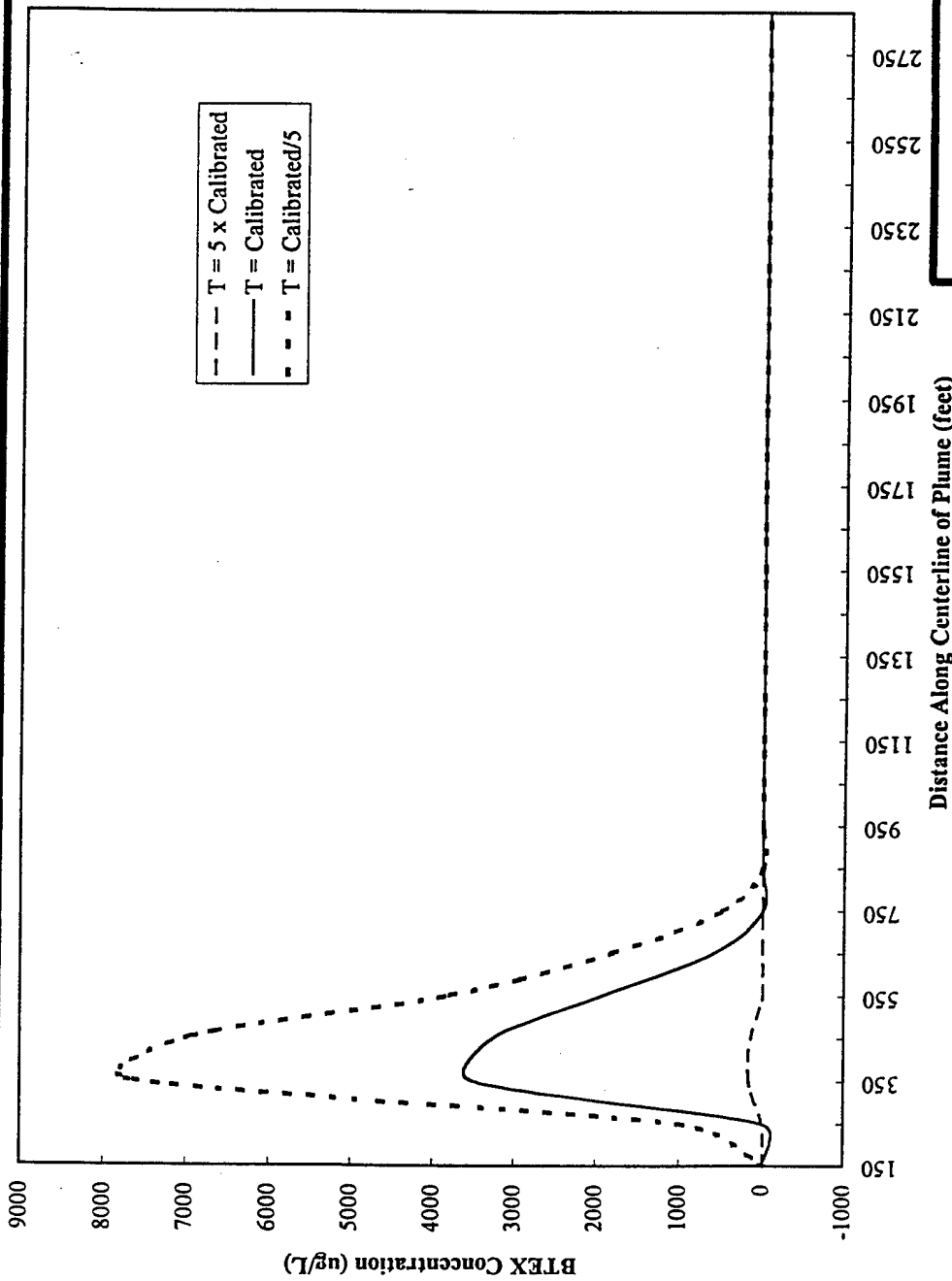

FIGURE 5.5

MODEL SENSITIVITY TO VARIATIONS IN TRANSMISSIVITY

Site ST-29
 Intrinsic Remediation TS
 Patrick Air Force Base, Florida



Denver, Colorado

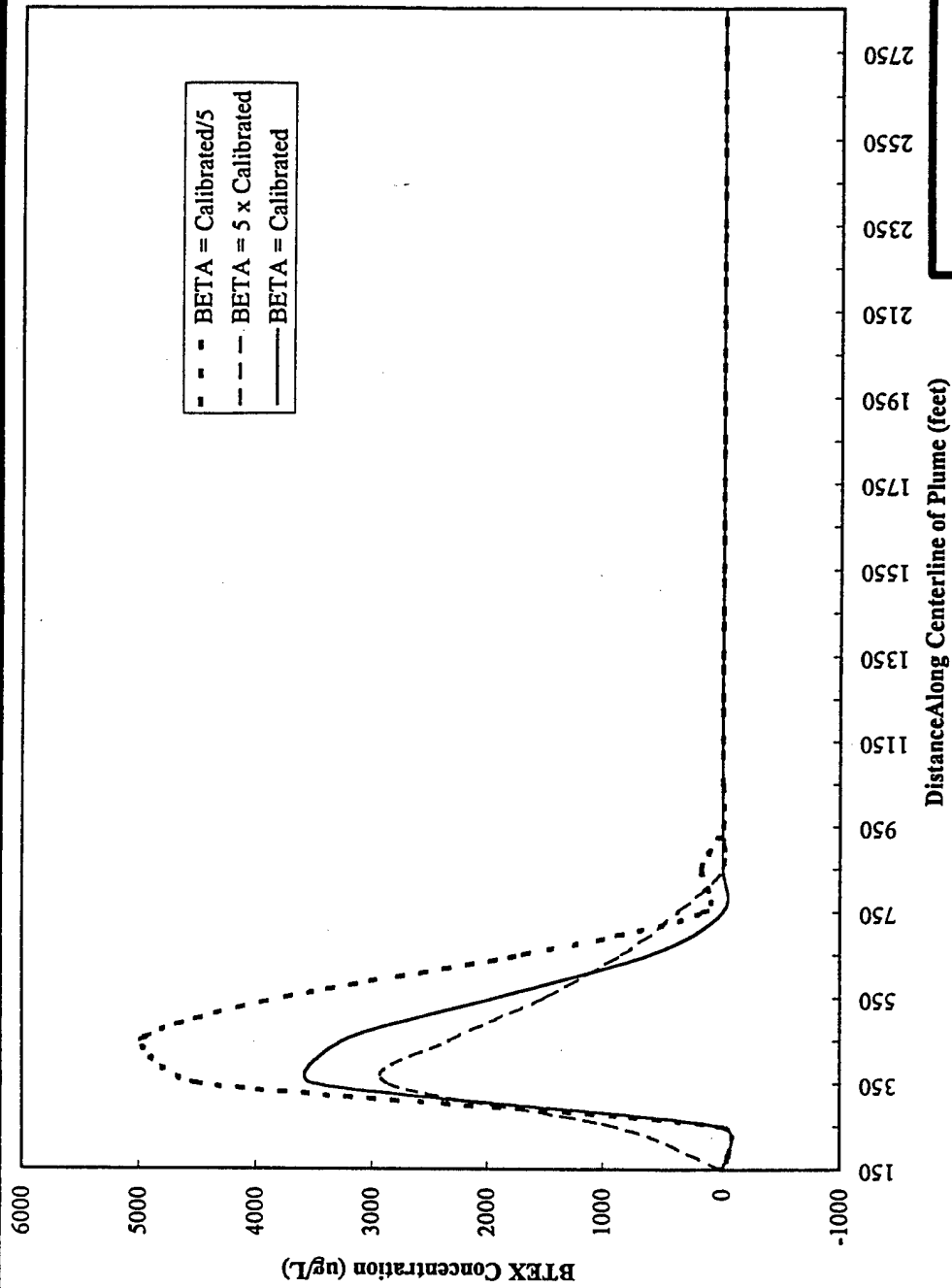

FIGURE 5.6

**MODEL SENSITIVITY
TO VARIATIONS
IN DISPERSIVITY**

Site ST-29
Intrinsic Remediation TS
Patrick Air Force Base, Florida



Denver, Colorado

FIGURE 5.7
PLOT OF TOTAL BTEX VS DISTANCE ALONG
PLUME CENTERLINE WITH VARYING DISPERSIVITY
UST SITE 870 INTRINSIC REMEDIATION EE/CA
HILL AFB, UTAH

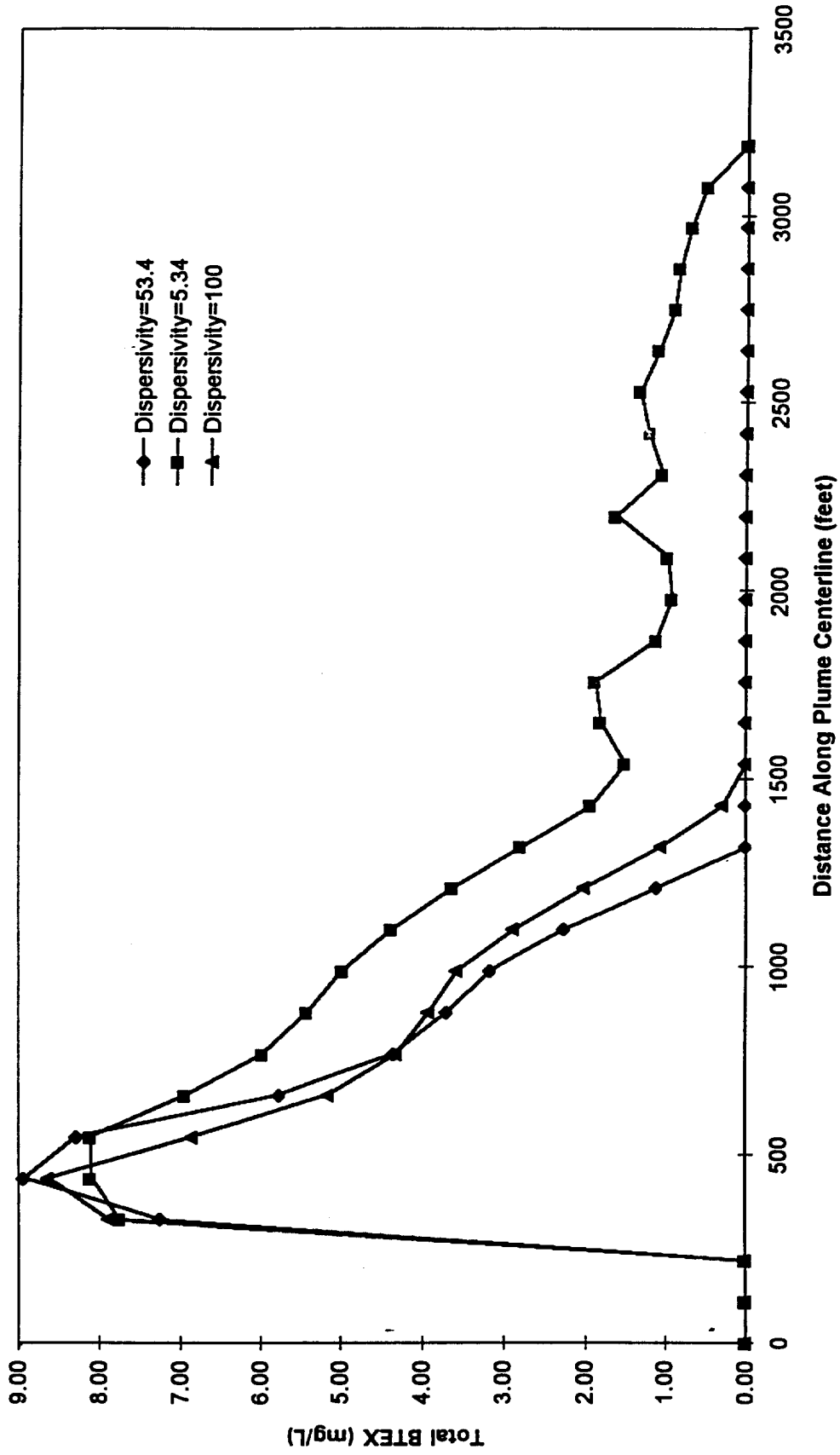

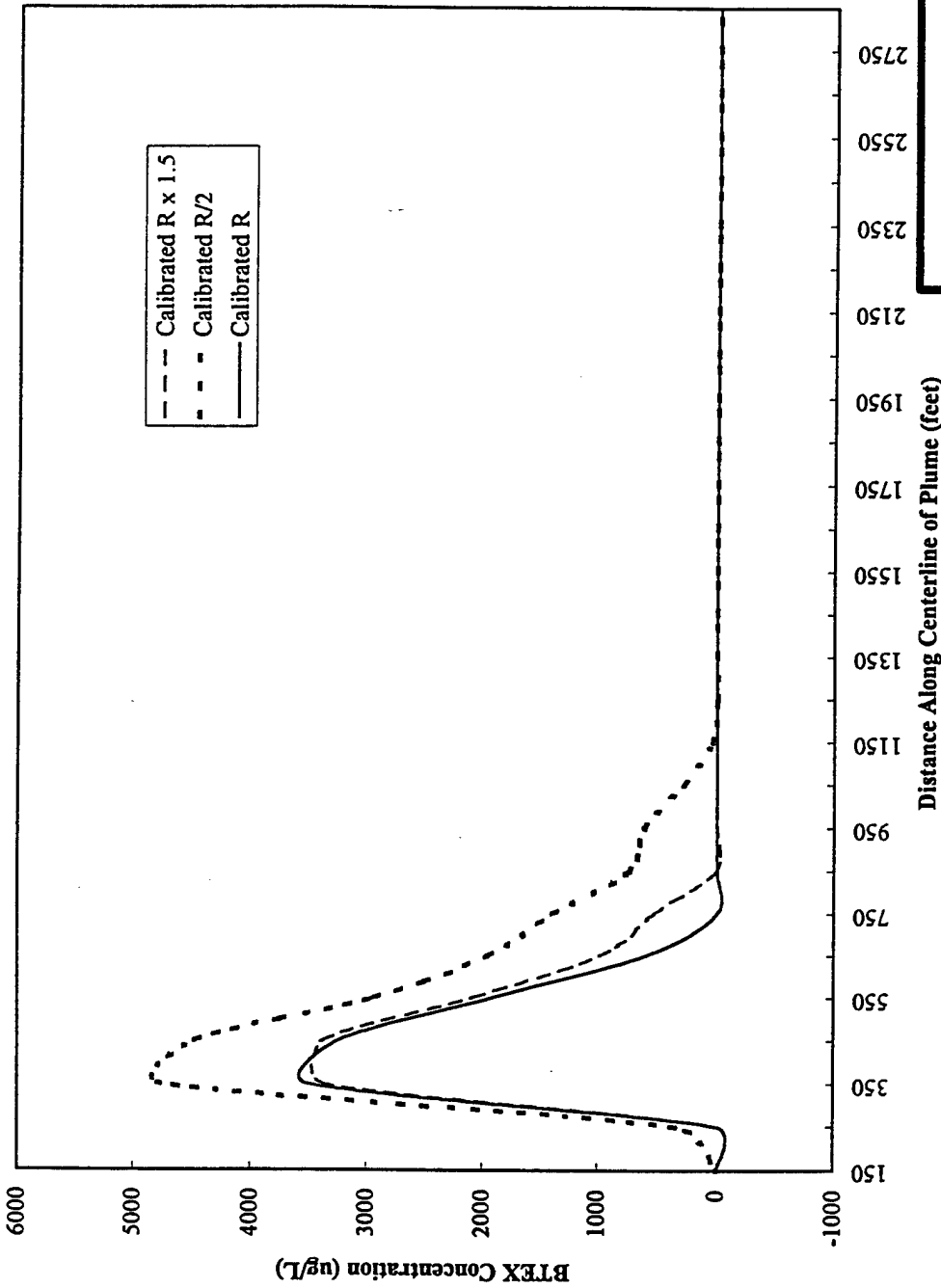

FIGURE 5.8

MODEL SENSITIVITY TO VARIATIONS IN THE COEFFICIENT OF RETARDATION

Site ST-29
 Intrinsic Remediation TS
 Patrick Air Force Base, Florida



PARSONS ENGINEERING SCIENCE, INC.
 Denver, Colorado

with the plume. Because more oxygen is present, biodegradation occurs more rapidly. Also, the faster groundwater velocity produced by the higher transmissivity initially results in greater spreading of the plume, further exposing the BTEX to oxygenated water. In contrast, decreasing the hydraulic conductivity by a factor of five slowed overall plume migration, which in turn caused an increase in measured BTEX concentrations in the source area and downgradient of the source area. Increased BTEX concentrations in the source area are caused by a reduction in the amount of oxygen being brought into contact with the plume from upgradient locations. This also results in a slightly more elongated plume, because the BTEX can travel farther without being biodegraded.

The effects of varying dispersivity are illustrated by Figure 5.6. Both longitudinal and transverse dispersivity were varied for this analysis, as the ratio of the two values was kept constant at 0.3. Increasing the dispersivity by a factor of five resulted in slightly lower maximum BTEX concentrations and a plume that extended slightly farther downgradient and upgradient from the source area (i.e., the plume was spread out over a greater area). Decreasing dispersivity by a factor of five produced a plume with an extent similar to the calibrated plume, but with higher concentrations.

Figure 5.7 shows the effects of varying the coefficient of reaeration. Increasing this parameter by a factor of five results in a much smaller plume with maximum BTEX concentrations approximately one-half those of the calibrated plume. This is a result of increased oxygen available for biodegradation. Conversely, decreasing the coefficient of reaeration by a factor of five decreases the amount of oxygen available for biodegradation, increasing the length of the plume by 200 feet and increasing the computed maximum BTEX concentrations to approximately 5,000 $\mu\text{g/L}$.

The effects of varying the coefficient of retardation (R) are shown by Figure 5.8. Increasing R by a factor of 1.5 does not have a significant effect on the contaminant distribution. The maximum BTEX concentration is nearly identical, and the plume is approximately 100 feet longer. On the other hand, decreasing R by a factor of two produces a plume that extends almost twice as far downgradient as the original plume and has a higher maximum concentration. These results suggest that the R used for the calibrated simulation is acceptable, as the model is relatively insensitive to higher values of R, while a value of R that is too low will result in a plume that is much larger than the observed plume.

The results of the sensitivity analysis suggest that the calibrated model used for this report is reasonable. The calibrated model is most sensitive to transmissivity and the reaeration coefficient, although the coefficient of retardation is also an important parameter. Increasing the coefficient of reaeration or the transmissivity greatly diminishes the predicted BTEX concentration and distribution. Lowering the values of all three variables lengthens the plume to beyond reasonable distances based on current observations at the site. While the model appears relatively insensitive to dispersivity, adjustment of that parameter contributed significantly toward producing an appropriate plume configuration.

5.6 MODEL RESULTS

To predict fate and transport of dissolved BTEX compounds at Site ST-29, two Bioplume II simulations were run under steady-state conditions. The first simulation assumed no source removal, with contaminant loading continuing at the rates which produced the calibrated model. The second simulation incorporated source reduction over 3 years, ultimately resulting in only 10 percent of the original source loading. This was done to estimate the impact of bioventing, which is currently in use in the source area north of the car wash. Complete input and output files are presented in Appendices C and D. Model results are described in the following sections.

5.6.1 No Source Removal (Model PATC)

Model PATC was used to simulate the migration and biodegradation of the BTEX plume assuming no source reduction or removal. In other words, the loading rates at the injection wells used to produce the calibrated BTEX plume were not reduced by any amount. Contamination therefore was continually introduced at a constant rate. This simulation was run for 50 years beyond the original calibrated model ending time, for a total simulation time of 58 years. Figure 5.9 shows the extent of the main body of the BTEX plume after 50 years of prediction time. Modeled concentrations of less than 10 µg/L were present another 100 feet downgradient of the plume front shown on Figure 5.9. A contour encircling these concentrations was not included because a concentration below 10 µg/L was computed for only one cell.

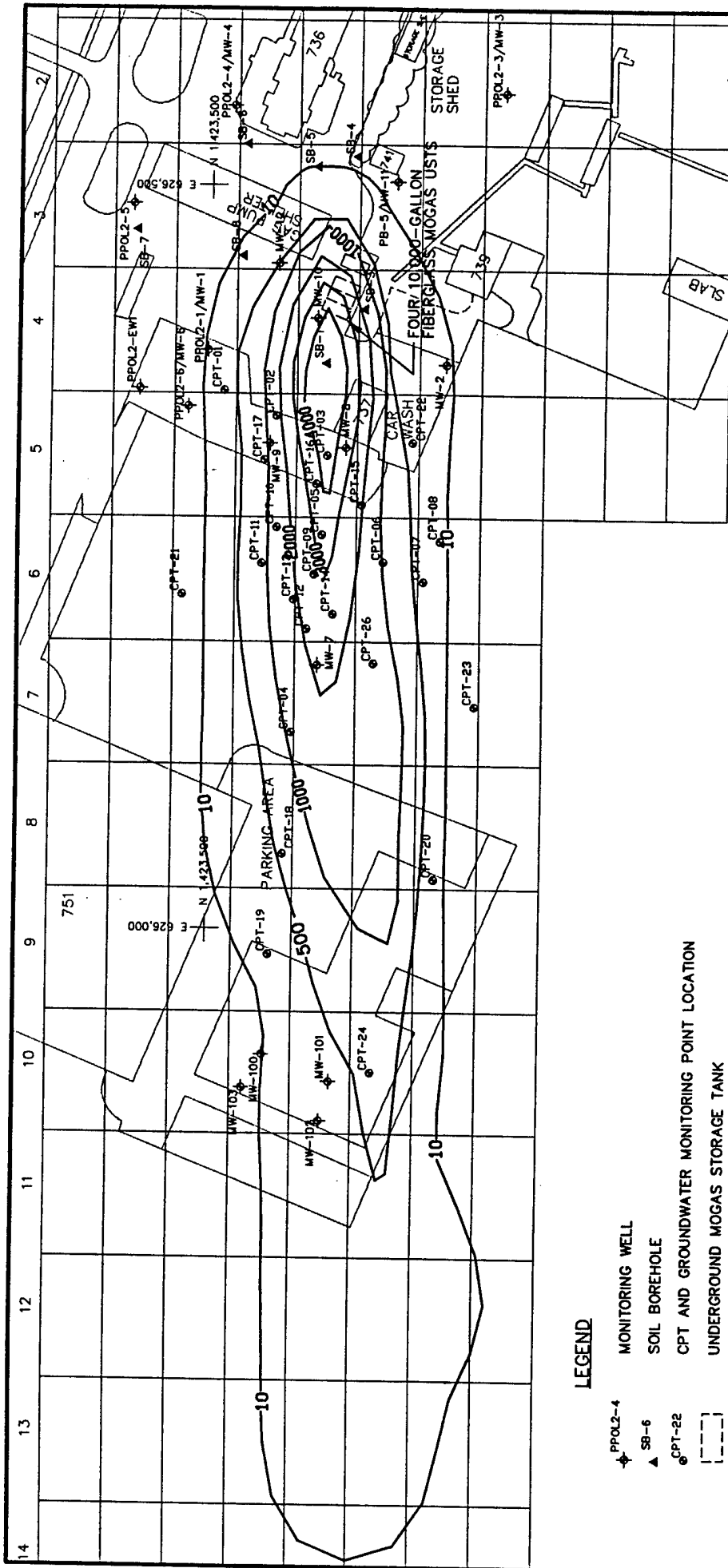

FIGURE 5.9
SIMULATED BTEX PLUME
AFTER 50 YEARS
(NO SOURCE REMOVAL)
MODEL PATC

Site ST-29
 Intrinsic Remediation TS
 Patrick Air Force Base, Florida

PARSONS
ENGINEERING SCIENCE, INC.
 Denver, Colorado

LEGEND

- ◆ PPOL2-4 MONITORING WELL
- ▲ SB-6 SOIL BOREHOLE
- CPT-22 CPT AND GROUNDWATER MONITORING POINT LOCATION
- ▭ UNDERGROUND MOGAS STORAGE TANK
- 50 LINE OF EQUAL TOTAL BTEX CONCENTRATION ($\mu\text{g/L}$)
- ☁ VEGETATION

CONTOUR INTERVAL = VARIABLE

NOTE:
 ALL TANK LOCATIONS ARE APPROXIMATE.

Throughout this simulation, dissolved BTEX concentrations in the source area increased gradually, with some regular fluctuation of the observed maximum values. This is likely a result of upgradient migration (as a result of dispersion) away from the source area depleting DO concentrations upgradient from the source area, and decreasing the biodegradation capacity of the groundwater entering the source area.

Contaminant migration was relatively slow within the first 10 years of prediction time, with the simulated plume front migrating only about 150 feet beyond the observed plume front. At this time, the BTEX concentration at the plume front was 161 $\mu\text{g/L}$. After 20 years, the computed plume front migrated another 300 feet, with the BTEX concentration at the head of the plume calculated as 35 $\mu\text{g/L}$. Migration was more rapid in the second 10 years of simulation because the plume reached the zone of higher transmissivity defined during calibration for grid rows 14 through 29. After 30 years, the plume extended another 200 feet downgradient, with a total BTEX concentration of 16 $\mu\text{g/L}$ in the cell furthest downgradient. The apparent velocity of the plume has slowed between the 20- and 30-year time step, as the increased distance from the source area results in a more dilute plume front that is more susceptible to biodegradation.

Between 30 and 50 years, the plume appears to stabilize, and the leading edge of the plume does not migrate beyond the extent reached after 30 years of prediction time. The plume front does not remain static in the simulation, cycling between the maximum computed extent and a point 500 feet upgradient. Because the plume front and the maximum concentrations in the source area fluctuate with a regular pattern, there is probably a mathematical instability in the finite difference solution of this problem. However, these results are still useful, indicating that with continuous BTEX loading, the plume is not likely to extend more than 1,200 feet beyond the source area as the plume front disperses and microorganisms are able to degrade hydrocarbons as fast as they are reaching the downgradient extent. In actuality, as the residual hydrocarbons in soil weather and degrade in the source area, the loading rates would decrease, maximum concentrations would decrease, and the dissolved BTEX plume would likely not extend as far downgradient as the model suggests.

5.6.2 Source Removal via Bioventing (Model PATD)

As discussed in Section 1.2, a pilot-scale bioventing system consisting of a 30-foot-long horizontal venting well was installed in the area north of the car wash building in March 1993. The location of this system was based on a soil gas survey that indicated that the highest hydrocarbon concentrations were in the area just north of the car wash. In soil gas samples collected during system installation, TVH concentrations in the source area ranged from 38,000 to 100,000 ppmv. Benzene was not detected, while toluene, ethylbenzene, and total xylenes concentrations ranged from 8.3 to 310 ppmv (ES, 1993).

Bioventing is an *in situ* process where low-flow air injection is used to enhance the biodegradation of organic contaminants in subsurface soils by supplying oxygen to indigenous microbes. The pilot-scale system began operating in October 1993, initially as an extraction system due to the high levels of petroleum hydrocarbons. After soil gas concentrations were reduced, the system was switched to air injection in early 1994. As an extraction system, the system extracted hydrocarbon-rich gas from the soil, allowing additional hydrocarbons to volatilize, and drawing in additional oxygen from surrounding soil. The influx of oxygen stimulated microbial degradation of hydrocarbons in the unsaturated zone, and likely increased the oxygen flux across the water table. As an injection system, the bioventing system is injecting air (with approximately 21 percent oxygen) at relatively low flow rates to stimulate additional biodegradation of the fuel residuals. This system increases the flux of oxygen across the water table. For both cases, BTEX compounds are preferentially removed because of their greater solubility and mobility compared to other fuel constituents. In addition, soil near and below the water table will be remediated during times of low water table. Testing during installation of the venting well indicates that the bioventing system is capable of increasing soil gas oxygen concentrations at least 37 feet in all directions from the well.

During initial testing of the bioventing system, results indicated that the system was capable of degrading 900 mg of fuel per kg of soil each year. Soil samples were collected during bioventing system installation, and the total recoverable petroleum hydrocarbon concentrations ranged from 11 to 2,730 mg/kg (ES, 1993). These results suggest that after 3 years, nearly all of the residual fuel in soil within the effective radius of the pilot venting well should be degraded, or equilibrium concentrations should be reached.

Site soil gas data suggest that since the system began operating in October 1993, soil gas hydrocarbon concentrations have decreased significantly. A sample of soil gas from

the bioventing well collected in February 1994 contained 1,100 ppmv of TVH. In addition, ethylbenzene and total xylenes were detected at concentrations of 2.3 and 12 ppmv, respectively. Benzene and toluene were not detected at a detection limit of 0.064 ppmv (ES, unpublished data). Comparison of these data to the data collected during system installation indicates a significant decrease in soil gas TVH and BTEX concentrations.

Evaluation of bioventing results at 16 other sites (including sites with conditions similar to those at Site ST-29) shows that after 1 year of operation, average BTEX concentrations in soil were reduced by 91 percent (for benzene) to greater than 99 percent (for ethylbenzene and xylenes) (ES, 1994b). During the same time frame, average soil TPH concentrations were reduced by 70 percent, confirming that the BTEX compounds are preferentially removed.

Given the record of bioventing performance and the site-specific soil gas sampling results, it appears that soil BTEX concentrations have been significantly reduced and will continue to be reduced while the pilot-scale bioventing system is in operation. Installation of a full-scale bioventing system (scheduled for 1995) will further reduce the mass of hydrocarbons in the entire contaminated vadose zone soil volume. Based on this information, another predictive model was set up to reflect source removal. As a starting assumption, this model (PATD) assumed that in 1 year of bioventing system operation, 50 percent of the soil BTEX was removed. In the second year of operation, the model set-up assumed that an additional 25 percent of the BTEX was removed. In the third and all subsequent years of operation, it was assumed that steady-state conditions were reached, with 10 percent of the BTEX remaining.

To simulate the reduction in BTEX concentrations, it was assumed that reductions in soil concentrations produced similar reductions in the BTEX loading rates. For example, for the first predictive year of the PATD simulation (year 9 of the total simulation), the loading rates at each injection well were reduced to 50 percent of the calibrated model rates. In the second predictive year the loading rates were decreased to 25 percent of the original rates, and in the third and all subsequent years the loading rates were left at 10 percent of the original rates. While the absence of confirmatory soil samples makes it difficult to quantify the actual decrease in loading rates that will be brought about by bioventing, the model based on this assumption can provide an indication of the potential

effects of source reduction. Confirmatory soil sampling will take place in the bioventing pilot test area in December 1994.

Model results for this case suggest that within 7 years after source reduction began, the dissolved BTEX compounds will not be present in groundwater at the site. Reduction of the source results in rapid biodegradation of the remaining concentrations of hydrocarbons, because the lower loading rates do not introduce BTEX into the aquifer at a rate that outpaces the rate of biodegradation and the rate of sorption onto the aquifer matrix. Figures 5.10, 5.11, and 5.12 show the results of this model after 2, 3, and 5 years of source reduction, respectively.

After 2 years (Figure 5.10), the plume has not migrated beyond the observed extent, while the maximum calculated concentration in the source area actually increases to 4,253 $\mu\text{g/L}$. After 3 years (Figure 5.11) the plume front was only about 100 feet beyond the observed limit, and the maximum calculated concentration decreases to 948 $\mu\text{g/L}$. Five years after source reduction is initiated, the model predicts that the plume front retreats to the approximate extent of the observed plume (Figure 5.12), and the maximum calculated concentration decreases to 326 $\mu\text{g/L}$. Seven years after source reduction began, the dissolved BTEX plume is completely degraded.

5.7 CONCLUSIONS AND DISCUSSION

The results of two different Bioplume II model scenarios at the BX Service Station indicate that dissolved BTEX contamination is not likely to migrate more than 1,200 feet downgradient from the source area. The first scenario, model PATC, assumed that BTEX loading rates in the source area would remain constant (at the rates used to calibrate the BTEX plume) for the full duration of the simulation. The second scenario, model PATD, assumed that BTEX loading rates would be reduced via bioventing in the source area. PATC results suggest that after 30 years, the BTEX plume will reach its maximum extent, approximately 1,200 feet downgradient from the source area. PATD results suggest that after source reduction, BTEX compounds will migrate no more than 600 feet downgradient from the source area and will be degraded within 7 years.

Model results imply that as a worst-case scenario, BTEX compounds would migrate approximately 1,200 feet downgradient from the source area, or no more than 800 feet beyond the observed extent of the plume indicated by the March 1994 sampling results. Taking into account the model cell size and the resolution of concentrations at the margin

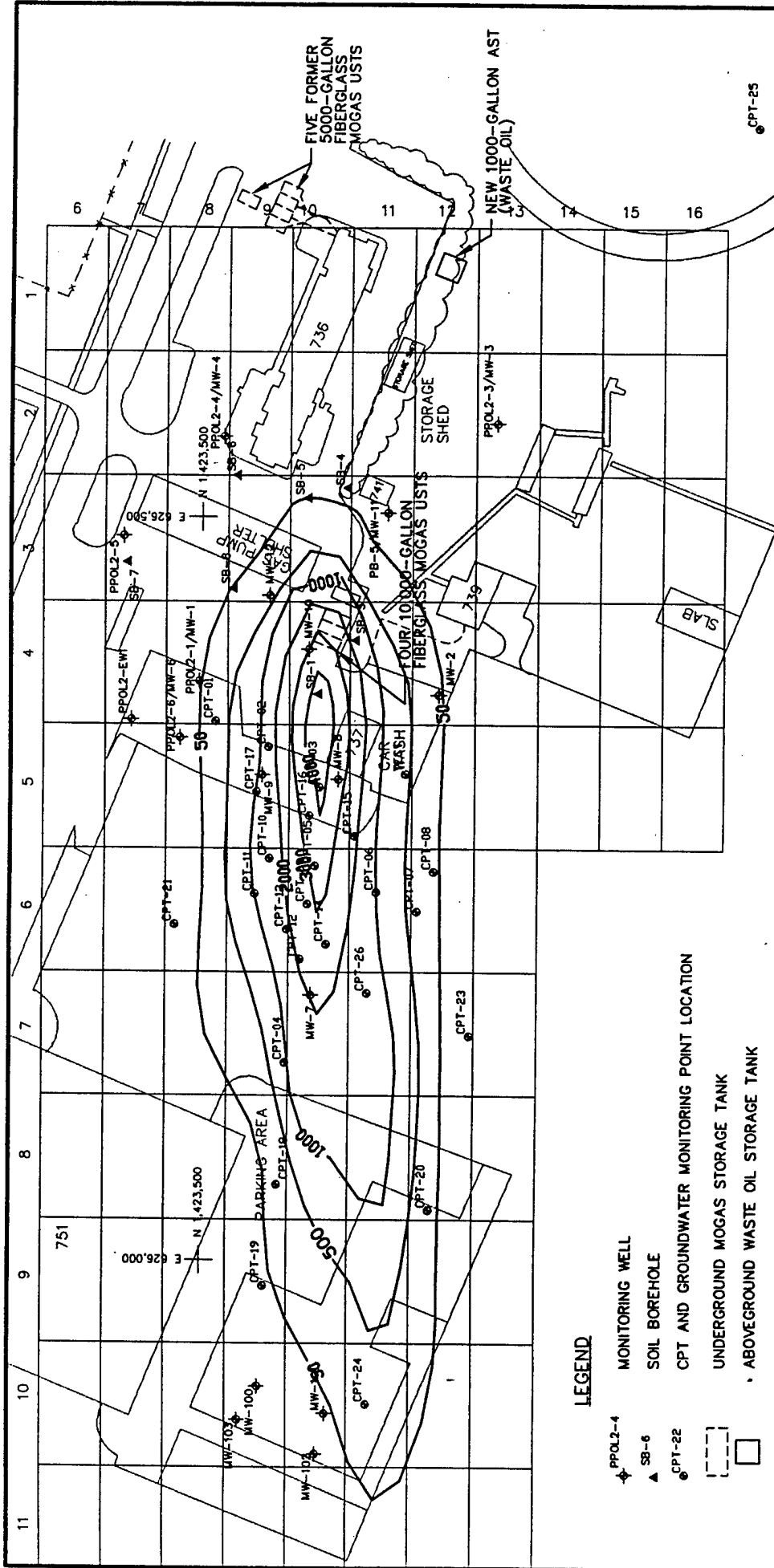

FIGURE 5.10
SIMULATED BTEX PLUME
AFTER 2 YEARS
(WITH SOURCE REDUCTION)
MODEL PATD

Site ST-29
 Intrinsic Remediation TS
 Patrick Air Force Base, Florida

PARSONS
ENGINEERING SCIENCE, INC.
 Denver, Colorado

- LEGEND**
- ◆ PPOL2-4 MONITORING WELL
 - ▲ SB-6 SOIL BOREHOLE
 - CPT-22 CPT AND GROUNDWATER MONITORING POINT LOCATION
 - ▭ UNDERGROUND MOGAS STORAGE TANK
 - ◻ ABOVEGROUND WASTE OIL STORAGE TANK
 - 50— LINE OF EQUAL TOTAL BTEX CONCENTRATION (µg/L)
 - ☁ VEGETATION
 - CONTOUR INTERVAL = VARIABLE

NOTE:
 ALL TANK LOCATIONS ARE APPROXIMATE.

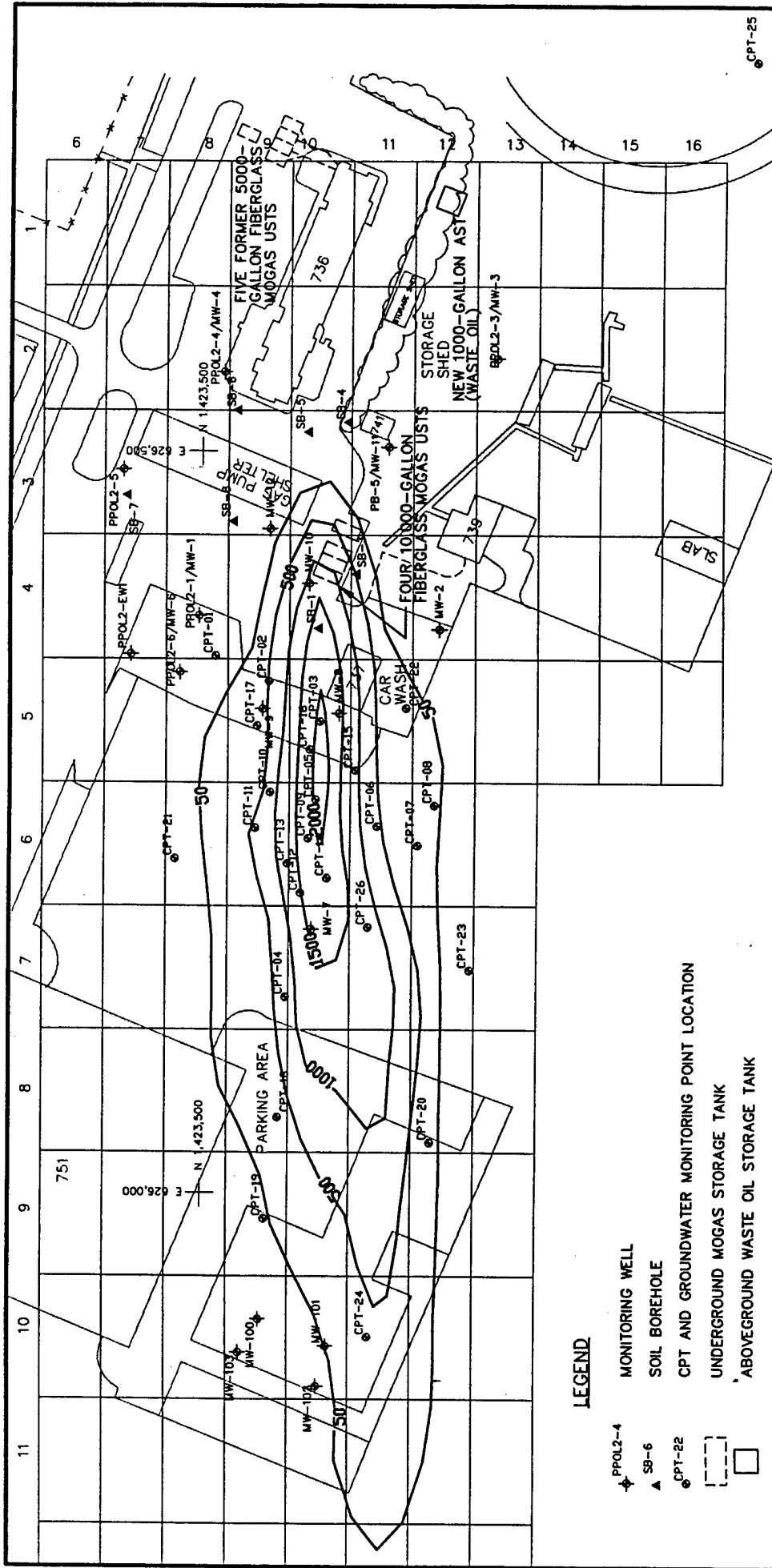

FIGURE 5.11
SIMULATED BTEX PLUME
AFTER 3 YEARS
(WITH SOURCE REDUCTION)
MODEL PATD

Site ST-29
 Intrinsic Remediation TS
 Patrick Air Force Base, Florida

PARSONS
ENGINEERING SCIENCE, INC.
 Denver, Colorado

LEGEND

- ◆ PPOL2-4 MONITORING WELL
- ▲ SB-6 SOIL BOREHOLE
- CPT-22 CPT AND GROUNDWATER MONITORING POINT LOCATION
- ▭ UNDERGROUND MOGAS STORAGE TANK
- ▭ ABOVEGROUND WASTE OIL STORAGE TANK
- 50— LINE OF EQUAL TOTAL BTEX CONCENTRATION (µg/L)
- ~ VEGETATION
- CONTOUR INTERVAL = VARIABLE

NOTE:
 ALL TANK LOCATIONS ARE APPROXIMATE.

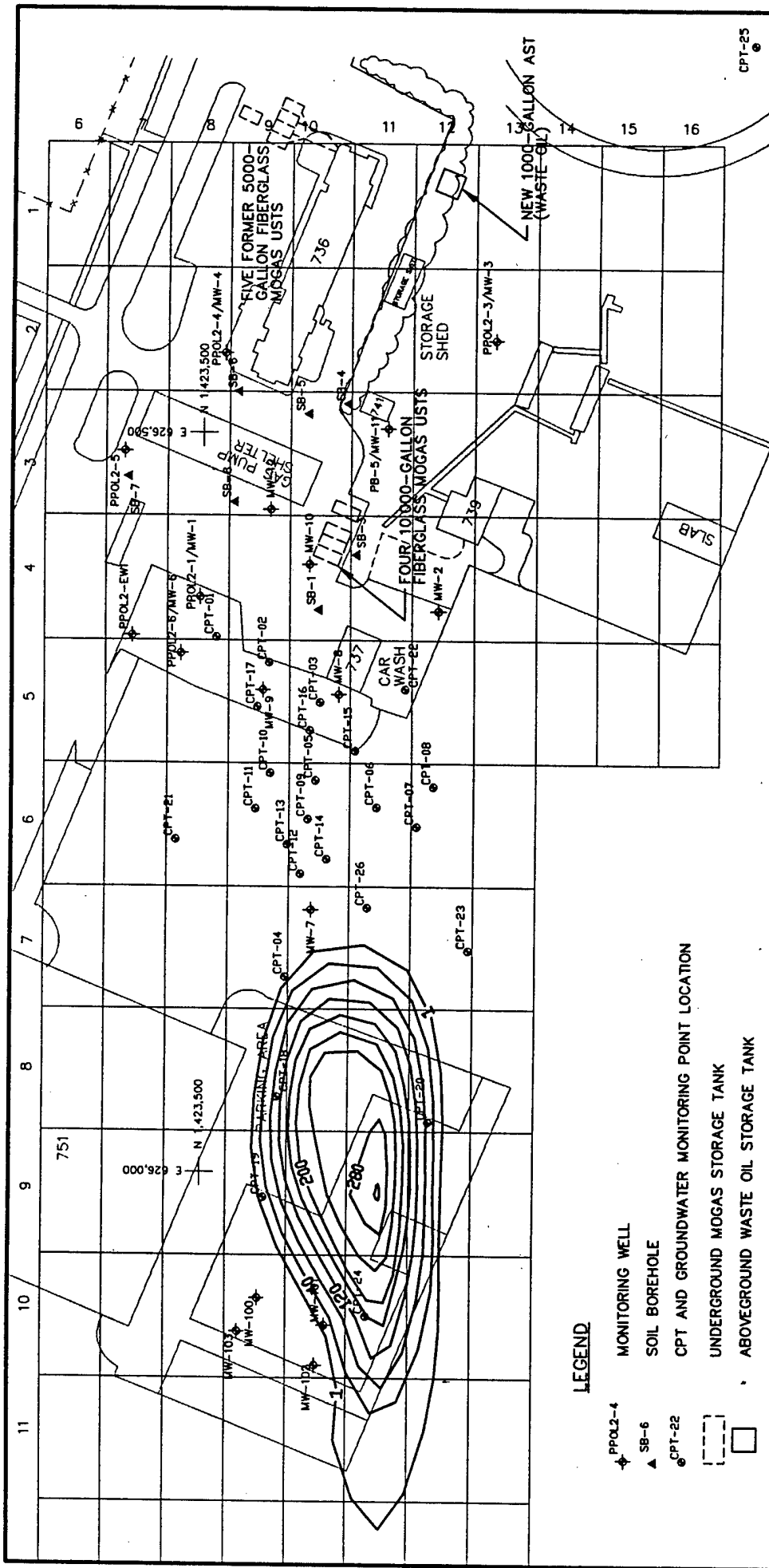

FIGURE 5.12
SIMULATED BTEX PLUME
AFTER 5 YEARS
(WITH SOURCE REDUCTION)
MODEL PATD
 Site St-29
 Intrinsic Remediation TS
 Patrick Air Force Base, Florida
PARSONS
ENGINEERING SCIENCE, INC.
 Denver, Colorado

of the plume, it appears unlikely that detectable concentrations of BTEX will reach the Banana River or any other potential receptors more than 1,400 feet downgradient from the site.

In both cases, model simulations are very conservative for several reasons, including:

- 1) Aerobic respiration, iron reduction, and methanogenesis are all occurring at this site; however, only DO was considered as an electron acceptor during model simulations;
- 2) The stoichiometry used to determine the ratio between DO and total BTEX assumed that no microbial cell mass was produced during the reaction. As discussed in Section 4.3.3.1, this approach may be too conservative by a factor of three.
- 3) The highest DO concentration observed at the site was 3.7 mg/L (CPR-25). The highest DO concentration assumed during model simulations was 3.5 mg/L.
- 4) A mid-range coefficient of retardation for benzene (2.7) was used for model simulations. Coefficient of retardation values for the other BTEX compounds range from 1.3 to 17.7. The use of the low coefficient of retardation tends to increase the distance traveled by the simulated BTEX plume, but provides a more accurate estimate of benzene transport.

Source reduction through bioventing, in concert with natural attenuation, can greatly impact the persistence of the BTEX contamination observed at the site. Comparing the results of the PATC model with the results of the PATD simulation shows the effects of source reduction, which allows for more rapid and thorough degradation of the BTEX compounds. The rapid degradation of BTEX observed in simulation PATD is feasible, given the observed DO concentrations, the maximum observed BTEX concentrations, and the conservative assumptions made in constructing the simulation. Bioventing is already in operation, and appears to have significantly reduced residual soil BTEX concentrations. Geochemical evidence also strongly suggests that anaerobic biodegradation is occurring in the central portions of the plume, which would further increase the rates of hydrocarbon consumption. Further, the high groundwater temperatures observed at this site are likely

to promote rapid reproduction of microorganisms, which would also result in more rapid degradation of hydrocarbons.

Models PATC and PATD represent two endpoints in a continuum of probable scenarios at Site ST-29. PATC represents the "worst case" in that it assumes BTEX dissolution into the aquifer will continue at the same rate indefinitely, while BTEX loading rates should actually decrease as the residual product weathers and the continuing dissolution removes more and more of those compounds. Model PATD is a more realistic prediction that assumes removal of BTEX from the soil via bioventing will result in a proportional decrease in BTEX partitioning into the aqueous phase. It is likely that future site conditions will fall somewhere between these endpoints, with the plume not extending as far as indicated by PATC, but with BTEX in the source area persisting longer than predicted by PATD.

SECTION 6

COMPARATIVE ANALYSIS OF REMEDIAL ALTERNATIVES

This section presents the development and comparative analysis of two groundwater remedial alternatives for Site ST-29, the BX Service Station, at Patrick AFB. The intent of this evaluation is to determine if intrinsic remediation is an appropriate and cost-effective remedial approach to consider when developing final remedial strategies for Site ST-29, especially when combined with other innovative and conventional remedial technologies

Section 6.1 presents the evaluation criteria used to evaluate groundwater remedial alternatives. Section 6.2 discusses the development of remedial alternatives considered part of this demonstration project. Section 6.3 provides a brief description of each of these remedial alternatives. Section 6.4 provides a more detailed analysis of the remedial alternatives using the defined remedial alternative evaluation criteria. The results of this evaluation process are summarized in Section 6.5.

6.1 REMEDIAL ALTERNATIVE EVALUATION CRITERIA

The evaluation criteria used to identify the appropriate remedial alternative for shallow groundwater contamination at Site ST-29 were adapted from those recommended by the USEPA for selecting remedies for Superfund sites [Office of Solid Waste and Emergency Response (OSWER) Directive 9902.3]. These criteria included (1) long-term effectiveness and permanence, (2) technical and administrative implementability, and (3) relative cost. The following sections briefly describe the scope and purpose of each evaluation criterion. This report does not include a complete discussion of all potentially applicable regulatory objectives for the site. Rather, this report focuses on the potential use of intrinsic remediation and source reduction technologies to reduce BTEX concentrations within the shallow groundwater to regulatory concentrations intended to be protective of human health and the environment.

6.1.1 Long-Term Effectiveness and Permanence

Each remedial approach or remedial alternative (which can be a combination of remedial approaches such as intrinsic remediation and institutional controls) was analyzed to determine how effectively it will minimize groundwater plume expansion so that groundwater quality standards or target cleanup goals can be achieved at a downgradient point of compliance (POC). The expected technical effectiveness based on case histories from other sites with similar conditions also is evaluated. The ability to minimize potential impacts to surrounding facilities and operations is considered. Also, the ability of each remedial alternative to protect both current and potential future receptors from potential risks associated with site-related contamination in shallow groundwater is qualitatively assessed by conservatively estimating if a potential exposure pathway involving groundwater could be completed, either now or in the future. This evaluation criterion also included permanence and the ability to reduce contaminant mass, toxicity, and volume. Time to implementation and time until protection is achieved are described. Long-term reliability for providing continued protection, including an assessment of potential for failure of the technology and the potential threats resulting from such a failure, also is evaluated.

6.1.2 Implementability

The technical implementation of each remedial technology or remedial alternative was evaluated in terms of technical feasibility and availability. Potential shortcomings and difficulties in construction, operations, and monitoring are presented and weighed against perceived benefits. Requirements for any post-implementation site controls such as LTM and land or groundwater use restrictions are described. Details on administrative feasibility in terms of the likelihood of public acceptance and the ability to obtain necessary approvals are discussed.

6.1.3 Cost

The total cost (present worth) of each remedial alternative was estimated for relative comparison. An estimate of capital costs, and operations and post-implementation costs for site monitoring and controls is included. An annual inflation factor of 5 percent was assumed in discounted present worth calculations.

6.2 FACTORS INFLUENCING ALTERNATIVES DEVELOPMENT

Several factors were considered during the identification and screening of remedial technologies for addressing shallow groundwater contamination at Site ST-29. Factors considered included the objectives of the natural attenuation demonstration program; contaminant, groundwater, and soil properties; present and future land use; and potential receptors and exposure pathways. The following section briefly describes each of these factors and how they were used to narrow the list of potentially applicable remedial technologies to the final remedial alternatives considered for Site ST-29.

6.2.1 Program Objectives

The intent of the Natural Attenuation (Intrinsic Remediation) Demonstration Program sponsored by AFCEE is to develop a systematic process for scientifically investigating and documenting naturally occurring subsurface attenuation processes that can be factored into overall site remediation plans. The objective of this program and the specific Site ST-29 study is to provide solid evidence of intrinsic remediation of dissolved fuel hydrocarbon so that this information can be used by the Base and its prime environmental contractor(s) to develop an effective groundwater remediation strategy. A secondary goal of this multi-site initiative is to provide a series of regional case studies that demonstrate that natural processes of contaminant degradation can often reduce contaminant concentrations in groundwater to below acceptable cleanup standards before completion of potential exposure pathways.

Because the objective of this program is to study natural processes in the saturated zone rather than all contaminated media (soil, soil gas, etc.), technologies have been evaluated based on their potential impact on shallow groundwater and phreatic soils. Technologies that can reduce vadose zone contamination and partitioning of contaminants into groundwater have also been evaluated. Many of the source removal technologies evaluated in this section will reduce soil and soil gas contamination, but it is important to emphasize that the remedial alternatives developed in this document are not intended to remediate all contaminated media. Additional program objectives set forth by AFCEE include cost effectiveness and minimization of waste. Technologies that may meet these criteria include institutional controls, soil vapor extraction, bioventing, biosparging, groundwater pump and treat, and intrinsic remediation. Soil excavation, slurry walls, sheet piling, carbon adsorption, *ex situ* biological or chemical treatment, and onsite/offsite disposal are not attractive technology candidates for this site.

6.2.2 Contaminant Properties

The site-related contaminants considered as part of this demonstration at Site ST-29 are the BTEX compounds. The source of this contamination is weathered MOGAS present as residual contamination in capillary fringe and saturated soil within the source area of Site ST-29. The physiochemical characteristics of both MOGAS and the individual BTEX compounds will greatly influence the effectiveness and selection of a remedial technology.

Petroleum hydrocarbon mixtures, such as MOGAS, are comprised of over 300 compounds with different physiochemical characteristics. MOGAS is classified as an LNAPL with a liquid density of 0.68 to 0.76 gram per cubic centimeter (g/cc) at 20°C. Many compounds within MOGAS sorb very well to soil and are concentrated in the capillary fringe because the mixture is less dense than water. MOGAS is slightly soluble in water, with a maximum solubility of approximately 200 mg/L. MOGAS is also a primary substrate for biological metabolism. Simultaneous biodegradation of aliphatic, aromatic, and alicyclic hydrocarbons has been observed. In fact, mineralization rates of hydrocarbons in mixtures, such as MOGAS or JP-4, may be faster than mineralization of the individual constituents as a result of cometabolic pathways (Jamison *et al.*, 1975; Perry, 1984).

The BTEX compounds are generally volatile, highly soluble in water, and adsorb less strongly to soil than other hydrocarbons in a petroleum mixture. These characteristics allow the BTEX compounds to leach more rapidly from contaminated soil into groundwater and migrate as aqueous-phase contamination (Lyman *et al.*, 1992). All of the BTEX compounds are highly amenable to *in situ* degradation by both biotic and abiotic mechanisms.

Benzene is very volatile with a vapor pressure of 76 millimeters of mercury (mm Hg) at 20°C and a Henry's Law Constant of approximately 0.0054 atmosphere-cubic meters per mole (atm-m³/mol) at 25°C (Hine and Mookerjee, 1975; Jury *et al.*, 1984). The solubility of pure benzene in water at 20°C has been reported to be 1,780 mg/L (Verschueren, 1983). Benzene is normally biodegraded to carbon dioxide, with catechol as a short-lived intermediate (Hopper, 1978; Ribbons and Eaton, 1992).

Toluene is also volatile, with a vapor pressure of 22 mm Hg at 20°C and a Henry's Law Constant of about 0.0067 atm-m³/mol at 25°C (Pankow and Rosen, 1988; Hine and Mookerjee, 1975). Toluene sorbs more readily to soil media relative to benzene, but still is very mobile. The solubility of pure toluene in water at 20°C is approximately 515 mg/L at 20°C (Verschueren, 1983). Toluene has been shown to degrade to pyruvate, caetaldehyde, and completely to carbon

dioxide via the intermediate catechol (Hopper, 1978; Wilson *et al.*, 1986; Ribbons and Eaton, 1992).

Ethylbenzene has a vapor pressure of 7 mm Hg at 20°C and a Henry's Law Constant of 0.0066 atm-m³/mol (Pankow and Rosen, 1988; Valsaraj, 1988). Ethylbenzene sorbs more strongly to soils than benzene but less strongly than toluene (Abdul *et al.*, 1987). Pure ethylbenzene is also less soluble than benzene and toluene in water at 152 mg/L at 20°C (Verschueren, 1983; Miller *et al.*, 1985). Ethylbenzene ultimately degrades to carbon dioxide via its intermediate 3-ethylcatechol (Hopper, 1978; Ribbons and Eaton, 1992).

The three isomers of xylene have vapor pressures ranging from 7 to 9 mm Hg at 20°C and Henry's Law Constants of between 0.005 and 0.007 atm-m³/mol at 25°C (Mackay and Wolkoff, 1973; Hine and Mookerjee, 1975; Pankow and Rosen, 1988). Of all of the BTEX compounds, xylenes sorb most strongly to soil, but still can leach from soil into the groundwater (Abdul *et al.*, 1987). Pure xylenes have water solubilities of 152 to 160 mg/L at 20°C (Bohon and Claussen, 1951; Mackay and Shiu, 1981; Isnard and Lambert, 1988). Xylenes can degrade to carbon dioxide via pyruvate carbonyl intermediates (Hopper, 1978; Ribbons and Eaton, 1992).

Based on these physiochemical characteristics, intrinsic remediation, soil vapor extraction, bioventing, biosparging, groundwater extraction, and air stripping technologies could all be effective at collecting, destroying, and treating BTEX contaminants at Site ST-29.

6.2.3 Site-Specific Conditions

Two general categories of site-specific characteristics were considered when identifying remedial technologies for comparative evaluation as part of this demonstration project. The first category was physical characteristics such as groundwater depth, gradient, flow direction, and soil type, which influence the types of remedial technologies most appropriate for the site. The second category involved assumptions about future land use and potential receptors and exposure pathways. Each of these site-specific characteristics have influenced the selection of remedial alternatives included in the comparative evaluation.

6.2.3.1 Groundwater and Soil Characteristics

Site geology and hydrogeology will have a profound effect on the transport of contaminants and the effectiveness and scope of required remedial technologies at a given site. Hydraulic conductivity is perhaps the most important aquifer parameter governing groundwater flow and

contaminant transport in the subsurface. The velocity of the groundwater and aqueous-phase contamination is directly related to the hydraulic conductivity of the saturated zone. Rising head slug tests completed at Site ST-29 indicate a relatively high conductivity within the vicinity of the source area and dissolved BTEX plume. Estimated values ranged from 9.6×10^{-3} to 8.9×10^{-2} ft/min. These high values are characteristic of sandy materials (see Sections 4 and 5 of this report). The high hydraulic conductivity at this site directly influences the fate and transport of contaminants. The shallow groundwater plume has migrated relatively rapidly, increasing the extent of contamination (i.e., the plume has expanded) but decreasing the average concentration within the aquifer through dilution and increased biodegradation.

Although high hydraulic conductivity can result in plume expansion and migration, this same characteristic also will enhance the effectiveness of other remedial technologies, such as groundwater extraction, biosparging, and intrinsic remediation. For example, it should be less expensive and time-consuming to capture and treat the contaminant plume using a network of extraction wells in areas of high hydraulic conductivity. Contaminant recovery also may be maximized when contaminants are not significantly sorbed to and retarded by phreatic soil. However, the relatively high TOC content of Patrick AFB aquifer materials (0.016 to 1.86 percent) will tend to enhance sorption and decrease the mobility of all BTEX compounds. The effectiveness of biosparging also may be increased in highly conductive aquifers because of reduced entry pressures and increased radius of influence. Greater hydraulic conductivity also increases the amount of contaminant mass traveling through the biosparging network. The DO introduced through biosparging can also enhance aerobic degradation of the dissolved contaminant mass.

The rapid movement of contaminants within the subsurface away from the source also will increase the effectiveness of natural biodegradation processes by distributing the contaminant mass into areas enriched with electron acceptors. To satisfy the requirements of indigenous microbial activity and intrinsic remediation, the aquifer also must provide an adequate and available carbon or energy source, electron acceptors, essential nutrients, proper ranges of pH, temperature, and redox potential.

Data collected as part of the field work phase of this demonstration project and described in Sections 3 and 4 of this document indicate that Site ST-29 is characterized by adequate and available carbon/energy sources and electron acceptors to support measurable biodegradation of MOGAS contamination by indigenous microorganisms. Both DO and carbon dioxide (which is utilized during methanogenesis) represent significant sources of electron acceptor capacity for the biodegradation of BTEX compounds at the site. Further, because fuel hydrocarbon-degrading

microorganisms have been known to thrive under a wide range of temperature and pH conditions (Freeze and Cherry, 1979), the physical and chemical conditions of the groundwater and phreatic soil at Site ST-29 are not likely to inhibit microorganism growth.

Fuel hydrocarbon-degrading microorganisms are ubiquitous and as many as 28 hydrocarbon-degrading isolates (bacteria and fungi) have been discovered in different soil environments (Davies and Westlake, 1977; Jones and Eddington, 1968). Indigenous microorganisms have a distinct advantage over microorganisms injected into the subsurface to enhance biodegradation because indigenous microorganisms are well adapted to the physical and chemical conditions of the subsurface in which they reside (Goldstein *et al.*, 1985). Microbe addition was not considered a viable remedial technology for Site ST-29.

6.2.3.2 Potential Exposure Pathways

An exposure assessment identifies the potential human and ecological receptors that could potentially come into contact with site-related contamination and the pathways through which these receptors might be exposed. To have a completed exposure pathway, there must be a source of contamination, a potential mechanism(s) of release, a pathway of transport to an exposure point, an exposure point, and a receptor. If any of these elements do not exist, the exposure pathway is considered incomplete, and receptors will not come into contact with site-related contamination. Evaluation of the potential long-term effectiveness of any remedial technology or remedial alternative as part of this demonstration project includes determining if the approach will be sufficient and adequate to minimize plume expansion so that potential exposure pathways involving shallow groundwater are incomplete.

Assumptions about current and future land use at a site form the basis for identifying potential receptors, potential exposure pathways, reasonable exposure scenarios, and appropriate remediation goals. USEPA (1991) advises that the land use associated with the highest (most conservative) potential level of exposure and risk that can reasonably be expected to occur should be used to guide the identification of potential exposure pathways and to determine the level to which the site must be remediated. The source area consists of fuel storage and retail facilities associated with the BX Service Station. Warehouses/hangars, runway infields, and the Base sewage disposal plant are located to the west of Site ST-29. The area south and east of the site is occupied by aircraft runways and their associated infields. The groundwater plume originating from Site ST-29 is migrating to the west, and has impacted shallow groundwater in an area extending from the source area to an area just south of Building 751. The current land use within

and downgradient from the contaminant plume is entirely industrial. The Banana River is located approximately 2,600 to 2,800 feet downgradient from the site.

Under reasonable current land use assumptions, potential human receptors only include worker populations. It is unlikely that workers could be exposed to site-related contamination in phreatic soils or shallow groundwater unless this material was removed during future construction excavations or remedial activities. Utility workers could be exposed to shallow groundwater contamination if the plume impacts the storm drain located just west of the car wash. Shallow groundwater is not currently used to meet any demands at Patrick AFB. All on-Base water demands are met by deep supply wells and/or from water piped in from the City of Cocoa. Exposure pathways involving other environmental media such as shallow soils and soil gas in the source area were not considered as part of this project, but should be considered in overall site remediation decisions.

Ecological receptors typically include nondomestic plants and animals that could be exposed to affected site media. Unless groundwater discharges at the ground surface or into a surface water body, the only ecological receptors potentially exposed to contaminated groundwater are plants with root zones extending to the water table, and possibly burrowing animals. At Site ST-29, groundwater occurs at 4 to 5 feet bgs, which is conceivably within the root zone of some plants. However, the industrial setting of the site and the fact that the portion of the Base downgradient from Site ST-29 toward which the BTEX plume is migrating is entirely covered by concrete (Figure 1.1), seriously limits the types of potential vegetation or animal receptors present. Moreover, little information is available in the toxicological literature to suggest that exposure of plants or terrestrial animals to organic compounds such as BTEX poses a significant hazard (Micromedex, Inc., 1995).

No surface expression of groundwater has been observed at the BX Service Station; groundwater is expected to discharge to the Banana River, some 2,800 feet downgradient from the site. Migration to and discharge of contaminated groundwater into the Banana River could complete an exposure pathway to human or ecological receptors via dermal contact or possible ingestion, but it is very unlikely that detectable concentrations could reach the river. In addition, any contaminants reaching the river from Site ST-29 would likely be instantly diluted to nondetectable concentrations.

Assumptions about hypothetical future land uses must also be made to ensure that the remedial technology or alternative considered for shallow groundwater at the site is adequate and sufficient to provide long-term protection. No changes in land use are anticipated in the foreseeable future,

so use of an industrial land use assumption is the most appropriate. Thus, potential human future receptors include only worker populations. Special-concern ecological receptors are not likely to be exposed to adverse concentrations of BTEX in groundwater. The potential future exposure pathways involving workers are identical to those under current conditions provided shallow groundwater is not used to meet industrial water demands. In summary, the use of the intrinsic remediation technology at this site will require that the source area be maintained as industrial property and that restrictions on groundwater use be enforced in areas downgradient of Site ST-29 to the Banana River. If source removal technologies such as soil vapor extraction, bioventing, free product recovery, biosparging or groundwater pump and treat are implemented, they will have some impact on the short- and long-term land use options and will require some level of institutional control and worker protection during remediation.

6.2.3.3 Remediation Goals for Shallow Groundwater

Worst-case model results suggest that BTEX compounds are not likely to migrate more than 1,200 feet downgradient from the source area, assuming no additional contaminants (i.e., NAPLs) are discharged to the subsurface. As source-area remediation proceeds via bioventing, and as residual LNAPL weathers, BTEX loading rates will decrease, and the extent of BTEX migration will likely be much more limited. Therefore, an area approximately 1,000 feet beyond the plume boundary observed in March 1994 has been identified as the POC for groundwater remedial activities because this appears to be the maximum extent of future contaminant migration. This is a suitable location for monitoring and for demonstrating compliance with protective groundwater quality standards, such as promulgated FAC groundwater cleanup levels or drinking water MCLs.

This remedial strategy assumes that compliance with promulgated, single-point remediation goals is not necessary if site-related contamination does not pose a threat to human health or the environment (i.e., exposure pathways are incomplete). Thus, the magnitude of required remediation in areas that can and will be placed under institutional control is different from the remediation that is required in areas that may be available for unrestricted use. The primary RAO for shallow groundwater within and downgradient of Site ST-29 is limited plume expansion to prevent exposure of downgradient receptors to concentrations of BTEX in groundwater, or Banana River surface water, at concentrations that exceed protective regulatory levels. This means that viable remedial alternatives must be able to achieve concentrations that minimize plume migration and/or expansion. The RAO for shallow groundwater at the POC is attainment of the state target cleanup levels for Class G-II groundwater for each of the compounds listed in Table 6.1. Although it is unlikely that groundwater would be ingested by humans, this level of

long-term protection is appropriate, because the shallow groundwater in this area is classed by FDER as G-II (potable). Moreover, attainment of the BTEX and VOC cleanup levels listed in Table 6.1 would ensure that state surface water criteria for the protection of aquatic organisms in the Banana River, all of which are equal to or greater than the groundwater levels listed in Table 6.1 (Chapter 62-302, FAC), also would be attained should the site contaminants reach the river.

In summary, available data suggest that there is no completed potential exposure pathway involving shallow groundwater under current conditions. It is likely that no potential exposure pathways involving shallow groundwater would be complete under future land use assumptions, provided use of groundwater as a potable or industrial source of water is prohibited by institutional controls within the source area and within an area approximately 1,400 feet downgradient of the source area, and provided the Banana River is not impacted. Thus, institutional controls are likely to be a necessary component of any groundwater remediation strategy for this site. The required duration of these institutional controls may vary depending on the effectiveness of the selected remedial technology at reducing contaminant mass and concentration in the groundwater.

TABLE 6.1

**POINT-OF-COMPLIANCE REMEDIATION GOALS
SITE ST-29 INTRINSIC REMEDIATION TS
PATRICK AFB, FLORIDA**

Compound	Groundwater Target Level ($\mu\text{g/L}$) ^{a/}
Benzene	1
Total Volatile Organic Aromatics	50
1,2-Dichloroethane	3
1,2-Dibromoethane	0.02
Lead	50
Methyl tert-butyl ether	50

a/ Source: Chapter 62-770.600(8), FAC.

6.2.4 Summary of Remedial Technology Screening

Several remedial technologies have been identified and screened for use in treating the shallow groundwater at Site ST-29. Table 6.2 identifies the initial remedial technologies considered as part of this demonstration and those retained for detailed comparative analysis. Screening was conducted systematically by considering the program objectives of the AFCEE intrinsic remediation demonstration, applicable state cleanup goals, physiochemical properties of the BTEX compounds, and other site-specific characteristics such as hydrogeology, land use assumptions, potential exposure pathways, and other appropriate remediation goals. All of these factors will influence the technical effectiveness, implementation, and relative cost of technologies for remediating shallow groundwater underlying and migrating from the site. The remedial approaches and technologies retained for development of remedial alternatives and comparative analysis include institutional controls, intrinsic remediation, LTM, bioventing/soil vapor extraction, and biosparging.

6.3 BRIEF DESCRIPTION OF REMEDIAL ALTERNATIVES

This section describes how remedial technologies/approaches retained from the screening process were combined into two remedial alternatives for Site ST-29. Sufficient information on each remedial alternative has been provided to facilitate a comparative analysis of effectiveness, implementability, and cost in Section 6.4.

6.3.1 Alternative 1 - Bioventing in Source Area, Intrinsic Remediation, and Institutional Controls with Long-Term Monitoring

Pilot-scale bioventing is underway in the source area at site ST-29. A single, horizontal-well bioventing system is currently injecting air into the subsurface and providing oxygen to approximately 1,000 to 1,200 cubic yards of the most contaminated unsaturated soils. In 1995, the existing bioventing system will be expanded by the installation of additional vent wells in the source area. Under this alternative, bioventing activities would continue (with the expanded system), but no additional source removal technologies would be employed. As indicated in Section 5.7.2, it has been estimated that this system will result in removal of 90 percent of the residual soil BTEX compounds within 3 years with an assumed proportional decrease in BTEX dissolution into shallow groundwater. Bioventing is preferred over soil vapor extraction because bioventing uses low rates of air injection that do not create vapor emissions into the atmosphere.

TABLE 6.2
INITIAL TECHNICAL IMPLEMENTABILITY SCREENING OF
TECHNOLOGIES AND PROCESS OPTIONS FOR GROUND WATER REMEDIATION
SITE ST-29 INTRINSIC REMEDIATION TS
PATRICK AFB, FLORIDA

General Response Action	Technology Type	Process Option	Implementability	Retain
Long-Term Monitoring	Periodic Ground Water Monitoring	Confirmation Wells	Many existing wells are available to confirm the progress of remediation.	Yes
		Point-of-Compliance Wells	Sufficient distance exists between the plume and point-of-compliance to locate several wells.	Yes
Institutional Controls	Ground Water Use Control	Land Use Control/Regulate Well Permits	Plume area is currently within the base boundary and land-use and ground water use are under base jurisdiction.	Yes
		Seal/Abandon Existing Wells	No production wells are known to exist in the existing or predicted plume area.	No
		Point-of-Use Treatment	No ground water is extracted from the plume area for any use.	No
		Meetings/Newsletters	Base public relations and environmental management offices have many information avenues to workers and residents.	Yes
Containment of Plume	Hydraulic Controls	Passive Drain Collection	No likely receptors downgradient of site. Installation could disrupt base operations.	No
		Minimum Pumping/Gradient Control	A line or semicircle of vertical pumping wells could be located along the leading edge of plume to intercept and halt the advance of the plume. No likely receptors downgradient of site.	No
	Physical Controls	Slurry Walls/Grout Curtains	Requires significant disruption of base operating area. Limited effectiveness.	No
		Sheet Piling	Requires significant disruption of base operating area. Limited effectiveness.	No
		Biologically Active Zones	Natural biodegradation of BTEX compounds can be stimulated by allowing contaminated ground water to flow through an aquifer zone which has enhanced oxygen and nutrient conditions.	No

TABLE 6.2 (Continued)
INITIAL TECHNICAL IMPLEMENTABILITY SCREENING OF
TECHNOLOGIES AND PROCESS OPTIONS FOR GROUND WATER REMEDIATION
SITE ST-29 INTRINSIC REMEDIATION TS
PATRICK AFB, FLORIDA

General Response Action	Technology Type	Process Option	Implementability	Retain
In Situ Treatment	Biological	Oxygen and/or Nutrient Enhanced Biodegradation (Biosparging)	Differs from biologically active zone in that oxygen and/or nutrients are injected upgradient of plume and allowed to migrate downgradient. In theory, this method can more rapidly reduce higher BTEX concentrations in and immediately downgradient of the source area.	Yes
	Chemical/Physical	Intrinsic Remediation	A combination of natural biological, chemical, and physical removal mechanisms which occur to varying degrees on every site. Ground water sampling at Site ST-29 indicates that this is a major, ongoing remediation process.	Yes
		Air Sparging (Volatilization)	Injection of air into contaminated aquifer creating a mass transfer of BTEX into air bubbles and into vadose zone. Limited radius of influence and short-circuiting are common problems.	No
Aboveground Ground Water Treatment	Ground Water Extraction	Vertical Pumping Wells	Entire groundwater plume is pumped by installing numerous wells with submersible pumps. High cost and major disruption to area.	No
		Downgradient Horizontal Drains	See Passive Drain Collection.	No
	Biological	Bioreactors	High flow rates require excessive retention times and large reactors. BTEX is often volatilized in these systems.	No
	Chemical/Physical	Air Stripping	Cost-effective technology for removing varying concentrations of BTEX at higher flow rates. Potential permitting for air emissions.	No
		Activated Carbon	Cost prohibitive for more concentrated BTEX. Creates a carbon disposal problem.	No
		UV/Ozone Reactors	High flow rates require excessive retention times and large, expensive reactors.	No

TABLE 6.2 (Continued)
INITIAL TECHNICAL IMPLEMENTABILITY SCREENING OF
TECHNOLOGIES AND PROCESS OPTIONS FOR GROUND WATER REMEDIATION
SITE ST-29 INTRINSIC REMEDIATION TS
PATRICK AFB, FLORIDA

General Response Action	Technology Type	Process Option	Implementability	Retain
Aboveground Treatment	Direct Discharge to Industrial Waste Water Treatment Plant (IWWTP)		Viable option when an IWWTP is available and capable of handling BTEX and hydraulic loading.	No
		IWWTP	Viable option when access to sanitary sewer exists and hydraulic loading is acceptable. Ground water extraction is unlikely.	No
Treated Ground Water Disposal	Discharge to IWWTP or Sanitary Sewer	Sanitary Sewer	Viable option when access to sanitary sewer exists and hydraulic loading is acceptable.	No
		Vertical Injection Wells	Not recommended due to clogging and high maintenance.	No
		Injection Trenches	Require large trenches and can be subject to injection well permitting.	No
		Storm Drains	Viable option but generally requires NPDES or other discharge permit. Ground water extraction is unlikely.	No
		Dual-Pump Systems	Best suited for sites with >1 foot free product where aboveground ground water treatment already exists	No
		Skimmer Pumps/Bailers/Wicks	Best suited for sites with <1 foot free product where ground water pumping is undesirable.	No
		Total Fluids Pumping	Best suited for sites with thin saturated zones where excessive ground water will not be pumped.	No
		Bioslurping	Combined vapor extraction, bioventing and free product recovery system has been operated at some sites with limited success.	No
		Biological Landfarming	Excavation is not feasible at this site due to surface structures and facility use.	No
		Source Removal/Soil Remediation	Free Product Recovery	

TABLE 6.2 (Concluded)
INITIAL TECHNICAL IMPLEMENTABILITY SCREENING OF
TECHNOLOGIES AND PROCESS OPTIONS FOR GROUND WATER REMEDIATION
SITE ST-29 INTRINSIC REMEDIATION TS
PATRICK AFB, FLORIDA

General Response Action	Technology Type	Process Option	Implementability	Retain
	Excavation/ Treatment (cont'd)	Thermal Desorption	Excavation is not feasible at this site due to surface structures and site use.	No
	In Situ	Bioventing	Air injection to stimulate biodegradation of fuel residuals. Pilot system currently operating in source area.	Yes
		Soil Vapor Extraction	Vapor extraction has been successfully implemented at other sites. Requires expansive off-gas treatment.	Yes

Biosparging should be considered as an additional source removal mechanism. Bioventing and biosparging could easily be combined at this site by injecting air several feet below the groundwater surface and allowing air (oxygen) to move upward through the capillary fringe and into the contaminated vadose zone. This combination of two technologies using a single air injection well should be considered when designing the full-scale bioventing system. Biosparging would also increase the DO content of the groundwater and promote more rapid degradation of BTEX compounds in the plume.

Intrinsic remediation is achieved when naturally occurring attenuation mechanisms bring about a reduction in the total mass of a contaminant in the soil or dissolved in groundwater. Intrinsic remediation results from the integration of several subsurface attenuation mechanisms that are classified as either destructive or nondestructive. Destructive attenuation mechanisms include biodegradation, abiotic oxidation, and hydrolysis. Nondestructive attenuation mechanisms include sorption, dilution (caused by dispersion and infiltration), and volatilization. In some cases, intrinsic remediation will reduce dissolved contaminant concentrations below numerical concentration goals intended to be protective of human health and the environment. Based on the existing evidence of intrinsic remediation described in Section 4, these processes are occurring at Site ST-29 and will continue to reduce contaminant mass as the plume advances.

Results of model PATC suggest that if BTEX enters groundwater at a constant rate for an indefinite period of time, the dissolved BTEX plume should stabilize within approximately 30 years. This plume could extend to a maximum of 1,200 feet downgradient from the source area. This does not take into account source reduction through bioventing or weathering of the residual product trapped in the soil pores. Model PATD assumes a significant reduction in the rates of BTEX loading into the groundwater. After 7 years of source removal, the Bioplume II model predicts that the combination of source reductions and intrinsic remediation within the BTEX plume will significantly reduce its size and concentration. Under this scenario, model results show that it is unlikely that BTEX compounds would migrate more than 600 feet beyond the source area.

Implementation of Alternative 1 would require the use of institutional controls such as land use restrictions and LTM. Land use restrictions may include placing long-term restrictions on soil excavation within the source area and long-term restrictions on groundwater well installations within and downgradient of the source area. The intent of these restrictions would be to reduce potential receptor exposure to contaminants by legally restricting activities within areas affected by site-related contamination. The two previously discussed model scenarios delineate the minimum and maximum possible plume migration distances. Future plume migration and

degradation will most likely result in conditions that fall between these limits. To be conservative, the results of model PATC should be considered in making decisions regarding groundwater monitoring and potential land use restrictions.

At a minimum, groundwater monitoring would be conducted twice annually as part of this remedial technology to evaluate the progress of natural attenuation processes. Based on the potential plume migration suggested by model PATC, it is unlikely that benzene concentrations exceeding the state target cleanup goal of 1 µg/L would be present more than 1,200 feet downgradient of the source area (this would be true even if it were assumed that model contaminant concentrations are all benzene rather than total BTEX). Results of model PATD suggest that, at its maximum extent, the BTEX plume would reach no more than 600 feet beyond the source area.

Because there are no apparent downgradient receptors, POC wells should be placed downgradient from the modeled maximum extent (i.e., slightly more than 1,200 feet downgradient of the source area). In addition, LTM wells within, upgradient and immediately downgradient of the existing BTEX plume would be used to monitor the effectiveness of intrinsic remediation. LTM wells are further described in Section 7.2.1. Detection of benzene in excess of 1 µg/L at the POC wells may require additional evaluation and modeling to assess BTEX migration and to determine if any BTEX will reach the Banana River, or to determine if additional corrective action would be necessary. Land and groundwater use restrictions would also require reevaluation.

Public education on the selected alternative would be developed to inform Base personnel and residents of the scientific principles underlying source reduction and intrinsic remediation. This education could be accomplished through public meetings, presentations, press releases, and posting of signs where appropriate. Periodic site reviews also could be conducted every year using data collected from the long-term groundwater monitoring program. The purpose of these periodic reviews would be to evaluate the extent of contamination, assess contaminant migration and attenuation through time, document the effectiveness of source removal and institutional controls at the site, and reevaluate the need for additional remedial actions at the site.

6.3.2 Alternative 2 - Intrinsic Remediation and Institutional Controls with Long-Term Groundwater Monitoring

This alternative is identical to Alternative 1 except that bioventing would not continue. Rapid reduction of soil BTEX (and TPH) concentrations would not occur, and the source area would

continue to contribute hydrocarbons to groundwater. Contaminant loading rates would eventually decrease, but more slowly than under Alternative 1.

As with Alternative 1, institutional controls and LTM would be required. POC wells would be installed in the same locations indicated in the previous section.

6.4 EVALUATION OF ALTERNATIVES

This section provides a comparative analysis of each of the remedial alternatives based on the effectiveness, implementability and cost criteria. A summary of this evaluation is presented in Section 6.5.

6.4.1 Alternative 1 - Continued Bioventing in Source Area, Intrinsic Remediation, and Institutional Controls with Long-Term Monitoring

6.4.1.1 Effectiveness

Section 5 of this document presents the results of the Bioplume II model completed to support the intrinsic remediation alternative at Site ST-29. The potential impacts of continued BTEX dissolution on groundwater contamination over time were incorporated into one of the models (PATC) for this remedial alternative. The other model (PATD) incorporated the effects of rapid and thorough reduction of BTEX loading rates by bioventing.

Model results predicted that natural attenuation mechanisms will significantly limit contaminant migration and reduce contaminant mass and toxicity. Benzene concentrations should not exceed the state groundwater standards/cleanup goals (Table 6.1) at the POC wells. The Bioplume II model is based upon numerous conservative assumptions and does not fully account for the anaerobic biodegradation caused by methanogenesis and other processes. In addition, it is highly unlikely that benzene concentrations in excess of 1 µg/L will reach the POC wells. Groundwater monitoring at the POC wells and other wells along the leading edge of the existing plume will ensure the protectiveness of this alternative. While this alternative would not cease to be protective if the benzene plume was intercepted by the POC wells, such an instance would indicate that site conditions should be reevaluated.

The effectiveness of this remedial alternative requires that excavations or drilling within the source area be conducted only by properly protected site workers. Reasonable land use assumptions for the plume area indicate that exposure is unlikely unless excavation or drilling

activities bring saturated soil to the surface. Long-term land use restrictions would be required to ensure that shallow groundwater will not be pumped or removed for potable use within, and approximately 1,000 feet in all directions from, the existing BTEX plume. Existing health and safety plans should be enforced to reduce risks from operating existing source reduction technologies and from installing and monitoring additional POC wells.

Compliance with program goals is one component of the long-term effectiveness evaluation criterion. Alternative 1 will satisfy program objectives designed to promote intrinsic remediation as a component of site remediation and to scientifically document naturally occurring processes.

Alternative 1 is based on the effectiveness of enhanced naturally occurring processes that minimize contaminant migration and reduce contaminant mass over time, and the effectiveness of institutional controls. As described earlier, an investigation of the potential effectiveness of naturally occurring processes at Site ST-29 using field data and the Bioplume II model demonstrated that the BTEX plume migration will be significantly limited. The sensitivity analysis completed on the Bioplume II model for this site (Section 5) suggests that even under the most conservative (i.e., worst-case) conditions, the naturally occurring processes at Site ST-29 should reduce contaminant migration so that the maximum distance traveled by the plume is unlikely to be beyond the proposed POC wells. The actual maximum migration distance is likely to be much less than the maximum predicted distance of 1,400 feet beyond the source area, due to the reduction of soil BTEX concentrations via bioventing.

Aside from the administrative concerns associated with long-term enforcement of long-term land use restrictions and long-term groundwater monitoring programs, this remedial alternative should provide reliable, continued protection. For cost comparison purposes, and based on Bioplume II modeling results, it is assumed that bioventing would continue for 3 years and that dissolved benzene concentrations will exceed state cleanup goals throughout the plume for approximately 7 years under Alternative 1. An additional 5 years of semiannual groundwater monitoring would be required to ensure that intrinsic remediation has uniformly reduced all BTEX compounds to concentrations below state MCLs.

6.4.1.2 Implementability

Alternative 1 is not technically difficult to implement. Expansion of the bioventing system is planned for 1995. Installation of POC wells and semiannual groundwater monitoring are both standard procedures. Long-term management efforts would be required to ensure proper sampling procedures are followed. Periodic site reviews should be conducted to confirm the

adequacy and completeness of LTM data and verify the effectiveness of this remediation approach. There may also be administrative concerns associated with long-term enforcement of groundwater use restrictions. Future land use within the source area may be impacted by leaving contaminated soil and groundwater in place. Regulators and the public would have to be informed of the benefits and limitations of the intrinsic remediation option. Educational programs are not difficult to implement, and the initial regulatory reaction to this alternative has been positive.

6.4.1.3 Cost

The cost of Alternative 1 is summarized in Table 6.3. Capital costs are limited to the construction of three new POC wells, two new LTM wells, and four new bioventing wells. The cost of maintaining the full-scale bioventing system for 3 years is included in the \$277,000 total present worth cost estimate for Alternative 1. Also included are the costs of maintaining institutional controls and long-term groundwater monitoring for a total of 12 years.

6.4.2 Alternative 2 - Intrinsic Remediation and Institutional Controls with Long-Term Groundwater Monitoring

6.4.2.1 Effectiveness

Because of the lack of a source removal component, the effectiveness of Alternative 2 is diminished compared to Alternative 1. However, this alternative also complies with the program goals because intrinsic remediation remains the predominant decontamination method for the site. State target cleanup goals will be achieved at the POC, as described in Alternative 1.

6.4.2.2 Implementability

The installation of POC and LTM wells, the institutional controls, and the long-term monitoring commitments described in Alternative 1 would be implemented with this alternative.

6.4.2.3 Cost

The estimated capital and operating costs of Alternative 2 are shown in Table 6.4. The total present worth cost of Alternative 2 is \$226,000. The cost of Alternative 2 will be decreased from

TABLE 6.3

ALTERNATIVE 1 - COST ESTIMATE
SITE ST-29 INTRINSIC REMEDIATION TS
PATRICK AFB, FLORIDA

<u>Capital Costs</u>	<u>Cost</u>
Design/Construct Three POC Wells and Two LTM Wells	\$14,000
Expand Bioventing System (4 new wells)	\$80,000
<u>Operation, Maintenance and Monitoring Costs (Annual)</u>	<u>Annual Cost</u>
Operate and Maintain Bioventing System (3 years)	\$12,000
Conduct Semiannual Groundwater Monitoring of 7 Wells (12 years)	\$6,000
Maintain Institutional Controls/Public Education (12 years)	\$5,000
Project Management (12 years)	\$6,000
<u>Present Worth of Alternative 1 ^{a/}</u>	<u>\$277,000</u>

^{a/} Based on an annual inflation (discount) factor of 5 percent.

TABLE 6.4
ALTERNATIVE 2 - COST ESTIMATE
SITE ST-29 INTRINSIC REMEDIATION TS
PATRICK AFB, FLORIDA

<u>Capital Costs</u>	<u>Cost</u>
Design/Construct Three POC Wells and Two LTM Wells	\$14,000
<u>Operation, Maintenance and Monitoring Costs (Annual)</u>	<u>Annual Cost</u>
Conduct Semiannual Groundwater Monitoring of 7 Wells (20 years)	\$6,000
Maintain Institutional Controls/Public Education (20 years)	\$5,000
Project Management (20 years)	\$6,000
<u>Present Worth of Alternative 2 ^{a/}</u>	\$226,000

^{a/} Based on an annual inflation (discount) factor of 5 percent.

the costs of Alternative 1 by the omission of bioventing, but monitoring would be continued for 20 years to verify that the plume continues to degrade and does not reach the POC wells. Based on model predictions, the plume will migrate farther downgradient than under Alternative 1, but it should not move more than 1,200 feet beyond the source area once it stabilizes. Annual long-term monitoring would continue for 20 years to ensure that intrinsic remediation is reducing BTEX concentrations below state cleanup goals throughout the plume. A monitoring period of 20 years was selected to allow sufficient time for weathering and degradation of residual LNAPL in the source area to reduce the introduction of dissolved BTEX into the shallow groundwater.

6.5 RECOMMENDED REMEDIAL APPROACH

Two remedial alternatives have been evaluated for remediation of the shallow groundwater at Site ST-29. Components of the alternatives evaluated include bioventing/biosparging, intrinsic remediation with LTM, and institutional controls. Table 6.5 summarizes the results of the evaluation based upon effectiveness, implementability, and cost criteria. Based on this evaluation, the Air Force recommends Alternative 1 as achieving the best combination of risk reduction and cost effectiveness.

A bioventing system is already operating, and the benefits of expanding and continuing the source reduction for 3 years should offset the additional capital and operating costs. Based on all effectiveness criteria, Alternative 1 will make maximum use of intrinsic remediation mechanisms to reduce plume migration and toxicity while providing the added benefits of enhanced *in situ* soil remediation in the source area and the introduction of additional oxygen into the groundwater in the vicinity of the bioventing well.

Both of the remedial alternatives are implementable; however, Alternative 1 more effectively reduces potential hydrocarbon migration and toxicity. This alternative should be acceptable to the public and regulatory agencies because it is protective of human health and the environment and reduces soil and groundwater contamination in a shorter time frame. Implementation of Alternative 1 will require land use and groundwater use controls to be enforced for approximately 12 years, along with semi-annual groundwater monitoring for the same period.

The final evaluation criterion used to compare each of the two remedial alternatives was cost. It is the opinion of the Air Force that the additional cost of Alternative 1 over Alternative 2 is justified by the additional protection it provides and the reduction in treatment time.

TABLE 6.5

SUMMARY OF REMEDIAL ALTERNATIVES EVALUATION
 GROUND WATER REMEDIATION
 SITE ST-29 INTRINSIC REMEDIATION EE/CA
 PATRICK AFB, FLORIDA

Remedial Alternative	Effectiveness	Implementability	Present Worth Cost Estimate
Alternative 1 - Continued (Expanded) Bioventing - Intrinsic Remediation - Long-Term Monitoring	Continued bioventing will gradually remove BTEX source. Contaminant mass, volume and toxicity will be significantly reduced over next seven years. MCL for benzene not likely to be exceeded at POC.	Readily implementable. Long-term management, ground water use controls and monitoring required for an estimated 12 years. Minimal exposure of site workers if excavation is carefully controlled in source area.	\$277,000
Alternative 2 - Intrinsic Remediation - Long-Term Monitoring	Similar to Alternative 1, with the omission of bioventing. Contaminant mass, volume, and toxicity will be reduced, but more slowly than in Alternative 1. Potential for MCLs to be exceeded at POC.	Readily implementable. Long-term management, ground water controls, and monitoring required for an estimated 20 years. If MCLs exceeded at POC, additional remedial work may be required.	\$226,000

SECTION 7

LONG-TERM MONITORING PLAN

7.1 OVERVIEW

In keeping with the requirements of the preferred remedial alternative for Site ST-29 (continued bioventing and intrinsic remediation with LTM), a long-term groundwater monitoring plan must be developed. The purpose of this component of the preferred remedial alternative for Site ST-29 is to assess site conditions over time, confirm the effectiveness of bioventing and naturally occurring processes at reducing contaminant mass and minimizing contaminant migration, and evaluate the need for additional remediation. The results of LTM can be used to validate model predictions and assure compliance with regulatory standards at the POC. If it is shown that the model does not accurately represent BTEX migration and attenuation at the ST-29 site, the model can be refined and recalibrated, as necessary.

To demonstrate attainment with both levels of site-specific remediation goals and to verify the accuracy of the Bioplume II model developed for Site ST-29, the LTM plan consists of identifying the location of two separate groundwater monitoring networks and developing a groundwater sampling and analysis strategy. The strategy described in this section is designed to monitor plume migration over time and to verify that intrinsic remediation is occurring at rates sufficient to protect potential receptors. In the event that data collected under this long-term program indicate that naturally occurring processes are insufficient to protect human health and the environment, this plan also describes contingency controls to augment the beneficial effects of intrinsic remediation.

As noted in Section 1.1, the scope of this project focuses on the intrinsic remediation of BTEX compounds; therefore, the plans specified in this section are geared toward monitoring for those specific target compounds. Clearly, any comprehensive monitoring program for this site also will need to include analyses specified in Chapter 62-770, FAC to meet the other target cleanup goals listed in Table 6.1.

7.2 MONITORING NETWORKS

Two separate sets of wells will be installed at Site ST-29 as part of the intrinsic remediation remedial alternative. The first set will consist of four wells located in, upgradient, and downgradient of the observed BTEX plume to verify the results of the Bioplume II modeling effort and to ensure that natural attenuation is occurring at rates sufficient to minimize plume expansion (i.e., meet the first level of remediation concentration goals for the site). This network of wells will consist of existing and proposed wells screened within the shallow aquifer to provide short-term confirmation and verification of the quantitative groundwater modeling results. The second set of groundwater monitoring wells will be located along a line slightly more than 1,200 feet downgradient from the source area (the POC for this demonstration project). The purpose of the POC wells is to verify that no BTEX compounds exceeding their state groundwater standards migrate beyond the area under institutional control (i.e., meet the second level of remediation concentration goals for the site). This network will consist of three groundwater monitoring wells screened across the first 10 feet of the shallow aquifer. Both LTM and POC wells will be sampled for analysis of the parameters listed in Tables 7.1 and 7.2, respectively.

7.2.1 Long-Term Monitoring Wells

At six locations, groundwater wells within, upgradient, and downgradient from the existing BTEX contaminant plume will be used to monitor the effectiveness of intrinsic remediation in reducing total contaminant mass and minimizing contaminant migration. Three locations will be within the anaerobic treatment zone. New monitoring wells at two downgradient locations will be placed beyond the aerobic treatment zone downgradient of the existing BTEX plume. In addition, one well upgradient of the existing plume will be monitored.

At four of the locations, existing monitoring wells/points will be used for this purpose. Well PB-5/MW-11 will be used to monitor conditions upgradient of the plume, while monitoring points CPT-03, CPT-14, and CPT-18 will be used to monitor conditions in the anaerobic treatment zone. For monitoring downgradient from the anaerobic treatment zone, wells should be installed at two new locations. Figure 7.1 identifies the proposed locations of each of these wells. This network will supplement the POC wells to provide early confirmation of model predictions and to allow additional response time if necessary. New

**TABLE 7.1
LONG-TERM MONITORING ANALYTICAL PROTOCOL
SITE ST-29 INTRINSIC REMEDIATION TS
PATRICK AIR FORCE BASE, FLORIDA**

Analyte	Method/Reference	Comments	Data Use	Recommended Frequency of Analysis	Sample Volume, Sample Container, Sample Preservation	Field or Fixed-Base Laboratory
Ferrous Iron (Fe ²⁺)	Colorimetric A3500-Fe D	Field only	Elevated ferrous iron concentrations may be indicative of the anaerobic biodegradation process of iron reduction	Semiannually for 12 Years	Collect 100 mL of water in a glass container; acidify with hydrochloric acid per method	Field
Ferrous Iron (Fe ²⁺)	Colorimetric HACH 25140-25	Alternate method; field only	Same as above.	Semiannually for 12 Years	Collect 100 mL of water in a glass container	Field
Temperature	E170.1	Field only	Metabolism rates for microorganisms depend on temperature	Semiannually for 12 Years	N/A	Field
Dissolved Oxygen	Dissolved oxygen meter	Refer to Method A4500 for a comparable laboratory procedure	The oxygen concentration is an indicator of biodegradation conditions; concentrations less than 1 mg/L generally indicate an anaerobic pathway	Semiannually for 12 Years	Collect 300 mL of water in biochemical oxygen demand bottles; analyze immediately; alternately, measure dissolved oxygen in situ	Field
pH	E150.1/SW9040, direct reading meter	Protocol/Handbook methods ^a	Acrobic and anaerobic processes are pH-sensitive	Semiannually for 12 Years	Collect 100-250 mL of water in a glass or plastic container; analyze immediately	Field
Conductivity	E120.1/SW9050, direct reading meter	Protocol/Handbook methods	General water quality parameter used as a marker to verify that site samples are obtained from the same groundwater system	Semiannually for 12 Years	Collect 100-250 mL of water in a glass or plastic container	Field
Nitrate (NO ₃ ⁻¹)	IC method E300 or method SW9056; colorimetric, method E353.2	Method E300 is a Handbook method; method SW9056 is an equivalent procedure	Substrate for microbial respiration if oxygen is depleted	Semiannually for 12 Years	Collect up to 40 mL of water in a glass or plastic container; cool to 4°C; analyze within 48 hours	Fixed-base

**TABLE 7.1 (CONCLUDED)
LONG-TERM MONITORING ANALYTICAL PROTOCOL
SITE ST-29 INTRINSIC REMEDIATION TS
PATRICK AIR FORCE BASE, FLORIDA**

Analyte	Method/Reference	Comments	Data Use	Recommended Frequency of Analysis	Sample Volume, Sample Container, Sample Preservation	Field or Fixed-Base Laboratory
Sulfate (SO ₄ ²⁻)	IC method E300 or method SW9056 or HACH SulfaVer 4 method	Method E300 is a Handbook method; method SW9056 is an equivalent procedure. HACH method is Photometric	Substrate for anaerobic microbial respiration	Semiannually for 12 Years	Collect up to 40 mL of water in a glass or plastic container; cool to 4°C	Fixed-base or field (for HACH method)
Redox potential	A2580 B	Measurements are made with electrodes; results are displayed on a meter; samples should be protected from exposure to atmospheric oxygen	The redox potential of groundwater influences and is influenced by biologically mediated reactions; the redox potential of groundwater may range from more than 200 mV to less than -400 mV	Semiannually for 12 Years	Collect 100-250 mL of water in a glass container, filling container from bottom; analyze immediately	Field
Methane, Ethane, and Ethene	RKSOP-114 modified to analyze water samples for methane by headspace sampling with dual thermal conductivity and flame ionization detection.	Method published and used by the USEPA Robert S. Kerr Laboratory	The presence of methane suggests BTEX degradation via an anaerobic pathway utilizing carbon dioxide (carbonate) as the electron acceptor (methanogenesis). The presence of ethane and ethene suggest that cometabolism of vinyl chloride is occurring.	Semiannually for 12 Years	Collect water samples in 40 mL volatile organic analysis (VOA) vials with butyl gray/Teflon-lined caps (zero headspace); cool to 4°C	Fixed-base
Aromatic hydrocarbons (BTEX)	Purge and trap GC method SW8020.	Handbook method; analysis may be extended to higher molecular weight alkylbenzenes	BTEX is the primary target analyte for monitoring natural attenuation; BTEX concentrations must also be measured for regulatory compliance	Semiannually for 12 Years	Collect water samples in a 40 mL VOA vial with zero headspace; cool to 4°C; add hydrochloric acid to pH < 2	Fixed-base

a/ Protocol methods are presented by Wiedemeier *et al.* (1995).

TABLE 7.2
POINT-OF-COMPLIANCE MONITORING ANALYTICAL PROTOCOL
SITE ST-29 INTRINSIC REMEDIATION TS
PATRICK AIR FORCE BASE, FLORIDA

Analyte	Method/Reference	Comments	Data Use	Recommended Frequency of Analysis	Sample Volume, Sample Container, Sample Preservation	Field or Fixed-Base Laboratory
Temperature	E170.1	Field only	Well development	Semiannually for 12 Years	N/A	Field
Dissolved Oxygen	Dissolved oxygen meter	Refer to method A4500 for a comparable laboratory procedure	The oxygen concentration is an indicator of biodegradation conditions; concentrations less than 1 mg/L generally indicate an anaerobic pathway	Semiannually for 12 Years	Collect 300 mL of water in biochemical oxygen demand bottles; analyze immediately; alternately, measure dissolved oxygen in situ	Field
pH	E150.1/SW9040, direct reading meter	Protocols/Handbook methods ^a	Aerobic and anaerobic processes are pH-sensitive	Semiannually for 12 Years	Collect 100-250 mL of water in a glass or plastic container; analyze immediately	Field
Conductivity	E120.1/SW9030, direct reading meter	Protocols/Handbook methods	General water quality parameter used as a marker to verify that site samples are obtained from the same groundwater system	Semiannually for 12 Years	Collect 100-250 mL of water in a glass or plastic container	Field
Redox potential	A2580 B	Measurements are made with electrodes; results are displayed on a meter; samples should be protected from exposure to atmospheric oxygen	The redox potential of groundwater influences and is influenced by biologically mediated reactions; the redox potential of groundwater may range from more than 200 mV to less than -400 mV	Semiannually for 12 Years	Collect 100-250 mL of water in a glass container, filling container from bottom; analyze immediately	Field
Lead	SW7421 or 239.2	Standard methods	Lead must be measured for regulatory compliance	Semiannually for 12 Years	Collect 100-250 mL of water in a glass or plastic container; add nitric acid to pH ≤ 2	Fixed-base
1,2-dichloroethane and EDB	Purge and trap GC method SW8010	Handbook method	Halogenated hydrocarbon concentrations must be measured for regulatory compliance	Semiannually for 12 Years	Collect water samples in a 40 mL VOA vial with zero headspace; cool to 4°C; add hydrochloric acid to pH ≤ 2	Fixed-base
Aromatic hydrocarbons (BTX), plus MTBE	Purge and trap GC method SW8020	Handbook method; analysis may be extended to higher molecular weight alkylbenzenes	BTX are the primary target analytes for monitoring natural attenuation; BTX and MTBE concentrations must also be measured for regulatory compliance	Semiannually for 12 Years	Collect water samples in a 40 mL VOA vial with zero headspace; cool to 4°C; add hydrochloric acid to pH ≤ 2	Fixed-base

^a Protocol methods are presented by Wiedemeier *et al.* (1995).

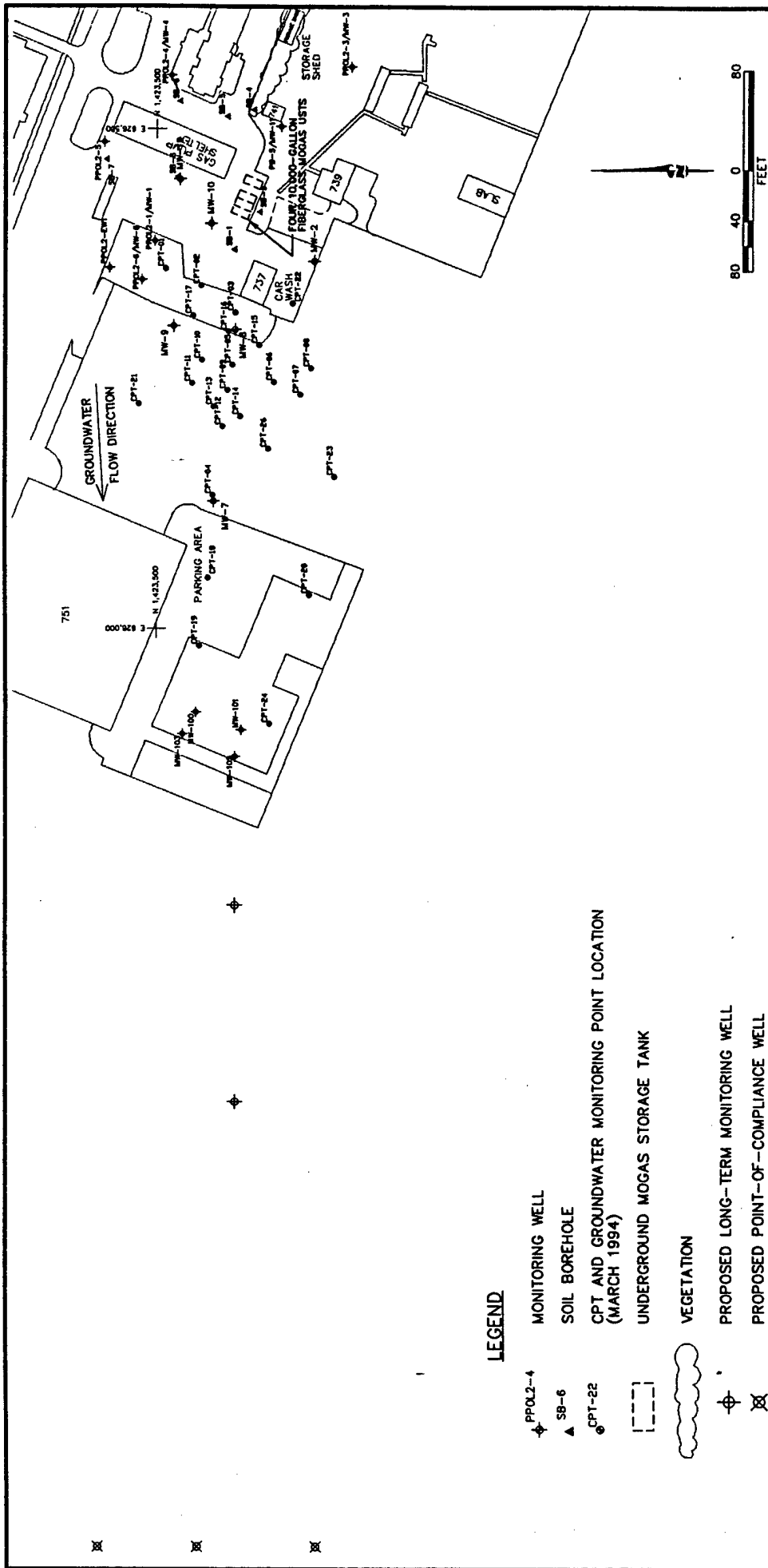

FIGURE 7.1
PROPOSED LOCATIONS OF
LONG-TERM MONITORING AND
POINT-OF-COMPLIANCE WELLS

Site ST-29
 Intrinsic Remediation TS
 Patrick Air Force Base, Florida

PARSONS
ENGINEERING SCIENCE, INC.
 Denver, Colorado

LEGEND

- ◆ PPT-2-4 MONITORING WELL
- ▲ SB-6 SOIL BOREHOLE
- PPT-22 CPT AND GROUNDWATER MONITORING POINT LOCATION (MARCH 1994)
- ▭ UNDERGROUND MOGAS STORAGE TANK
- ☁ VEGETATION
- ⊕ PROPOSED LONG-TERM MONITORING WELL
- ⊗ PROPOSED POINT-OF-COMPLIANCE WELL

NOTES:
 ALL TANK LOCATIONS ARE APPROXIMATE.

LTM wells will be constructed with 10-foot screens with approximately 8 feet of the screen below the water table. These wells will be sampled and analyzed for the parameters listed in Table 7.1 to verify the effectiveness of the intrinsic remediation remedial alternative.

7.2.2 Point-of-Compliance Wells

Three POC monitoring wells will be installed approximately 800 feet downgradient of the existing BTEX plume. Figure 7.1 also identifies the proposed locations of these wells. The purpose of these POC wells is to verify that no contaminated groundwater exceeding the state cleanup standards listed in Table 6.1 migrates beyond the area under institutional control. Although model results suggest that the contaminant plume will not migrate to or beyond this location at concentrations exceeding chemical-specific state standards, these POC wells are the technical mechanisms used to demonstrate protection of human health and the environment and compliance with site-specific numerical remediation goals. These wells will be installed and monitored for the parameters listed in Table 7.2 to assure that the selected remedy is providing the anticipated level of risk reduction and remediation at the site.

As with the LTM wells, the POC wells also will be screened in the same hydrogeologic unit as the contaminant plume. Data presented in this report about the nature and extent of contamination at the site suggest that a 10-foot screen extending from slightly above the surface of the groundwater to the shallow confining unit will be sufficient to intercept the contaminant plume at this site. Figure 7.2 is a proposed groundwater monitoring well completion diagram for both the LTM wells and the POC wells.

7.3 GROUNDWATER SAMPLING

To ensure that sufficient contaminant removal is occurring at Site ST-29 to protect human health and the environment and meet site-specific remediation goals, the long-term groundwater monitoring plan includes a comprehensive SAP. All LTM and POC wells will be sampled and analyzed twice each year to verify that naturally occurring processes are effectively reducing contaminant mass and mobility. Reductions in toxicity will be implied by mass reduction. The SAP will also be aimed at assuring intrinsic remediation can achieve site-specific remediation concentration goals for BTEX compounds and protect human health and the environment.

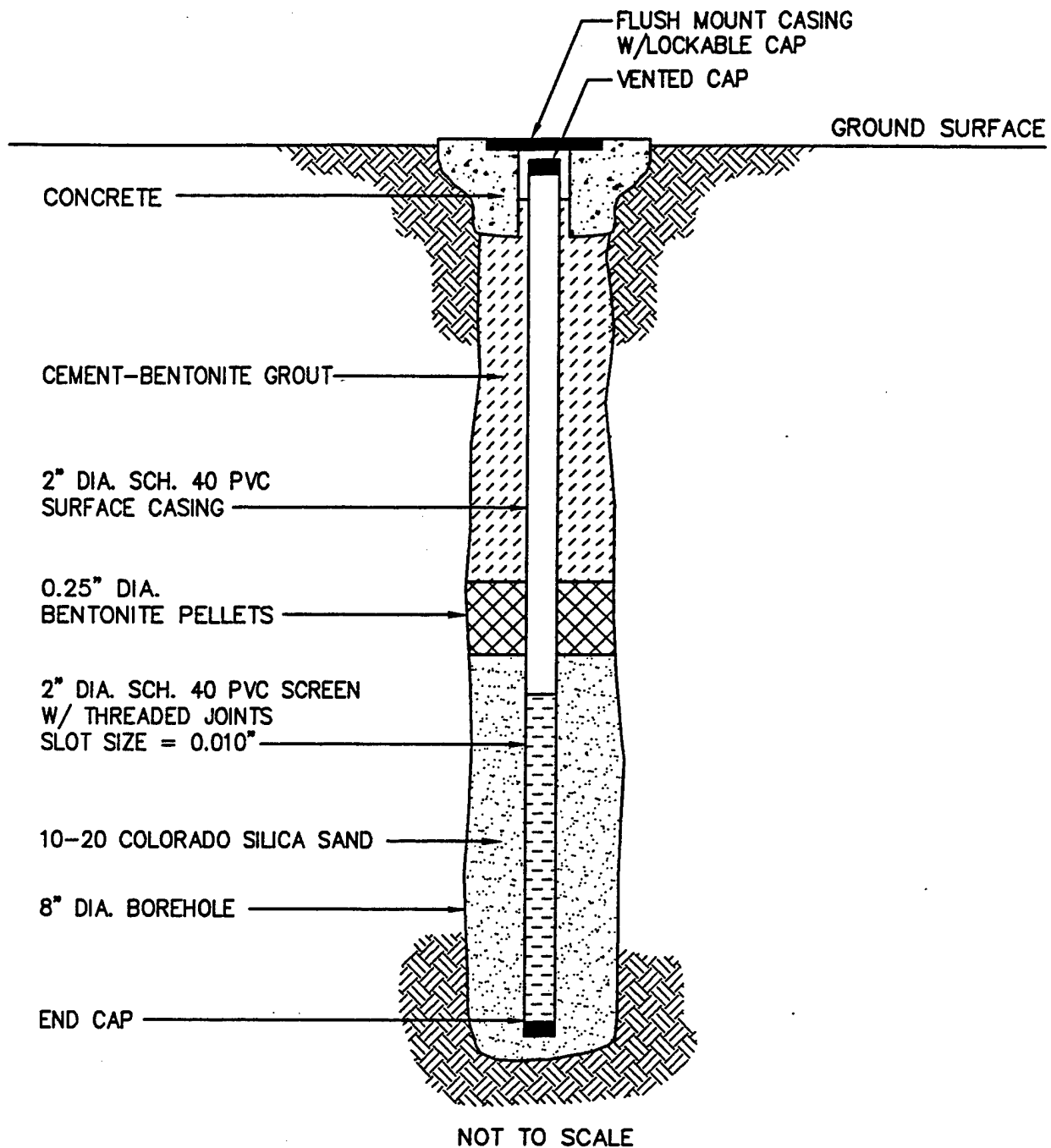

FIGURE 7.2

**PROPOSED MONITORING WELL
COMPLETION DIAGRAM**

Site ST-29
Intrinsic Remediation TS
Patrick Air Force Base, Florida

**PARSONS
ENGINEERING SCIENCE, INC.**

Denver, Colorado

7.3.1 Analytical Protocol

All LTM and POC wells in the LTM program will be sampled and analyzed to determine compliance with chemical-specific remediation goals (Table 6.1) and to verify the effectiveness of intrinsic remediation at the site. Water level measurements will be made during each sampling event. All groundwater samples will be analyzed for the parameters listed in Tables 7.1 and 7.2. A site-specific groundwater SAP should be prepared as part of the RAP prior to initiating the LTM program.

7.3.2 Sampling Frequency

Each of the LTM and POC sampling points will be sampled twice each year for 12 years. If the data collected during this time period supports the anticipated effectiveness of the intrinsic remediation alternative at this site, the sampling frequency can be reduced to once every year for all wells in the LTM program, or eliminated. If the data collected at any time during the monitoring period indicate the need for additional remedial activities at the site, sampling frequency should be adjusted accordingly.

SECTION 8

CONCLUSIONS AND RECOMMENDATIONS

This report presents the results of a TS conducted to evaluate the use of intrinsic remediation (natural attenuation) for remediation of fuel-hydrocarbon-contaminated groundwater at the BX Service Station (Site ST-29), Patrick AFB, Florida. Specifically, the finite-difference groundwater model Bioplume II was used in conjunction with site-specific geologic, hydrologic, and laboratory analytical data to simulate the migration and oxygen-limited biodegradation of fuel hydrocarbon compounds dissolved in groundwater. Groundwater contaminant and geochemical data strongly suggest that aerobic biodegradation of fuel hydrocarbons is occurring at the site. In addition, the data also suggest that anaerobic biodegradation is occurring via methanogenesis and, to a lesser degree, iron reduction.

To collect the data necessary for the intrinsic remediation demonstration, Parsons ES and USEPA researchers collected soil and groundwater samples from the site. Physical and chemical data collected under this program were supplemented with data collected during previous site characterization events. Site-specific geologic, hydrologic, and laboratory analytical data were then used in the Bioplume II numerical groundwater model to simulate the effects of advection, dispersion, sorption, and biodegradation on the fate and transport of the dissolved BTEX plume. Extensive site-specific data were used for model implementation. Model parameters that could not be obtained from existing site data were estimated using widely accepted literature values for sediments similar to those found at the site. Conservative aquifer parameters were used to construct the Bioplume II model for this study, and therefore, the model results presented herein represent conservative scenarios. It was also assumed that only aerobic biodegradation would occur.

For one simulation (model PATC), it was assumed that BTEX compounds will enter the aquifer at a constant rate. That rate was the same rate used to produce the initial calibrated model. Therefore, the results presented for PATC represent a worst-case scenario in which the BTEX plume equilibrates after about 30 years, with the leading edge of the plume stabilizing approximately 1,400 feet beyond the source area. For a second simulation (model

PATD), it was assumed that BTEX loading rates were significantly decreased by bioventing over a 3-year period. Results for PATD represent a reasonable, but still conservative scenario in which dissolved BTEX compounds would degrade to below detectable concentrations in 7 years.

Actual dissolved BTEX degradation rates observed during LTM at the site will probably be greater than predicted by model PATC and less than predicted by model PATD. This will result in faster removal rates of the BTEX compounds and a shorter plume migration distance than predicted by model PATC. In addition, bioventing should increase the diffusion of oxygen into groundwater across the soil gas-water interface. Increased diffusion causes increased ground-water reaeration, which further enhances biodegradation of dissolved petroleum hydrocarbons (Barr, 1993). Additional oxygen introduced into the subsurface by bioventing should further enhance biodegradation through oxygen diffusion across the water table, resulting in more rapid plume attenuation.

The results of this study suggest that natural attenuation of BTEX compounds is occurring at Site ST-29 to the extent that the concentrations of these compounds dissolved in groundwater should be reduced to concentrations below current regulatory guidelines long before potential downgradient receptors could be adversely affected (i.e., the potential contaminant migration pathway will not be complete for any of the potential receptors described in Section 6.2). Based on the distance to potential downgradient receptors (at least 2,500 feet to the Banana River) and rates of BTEX plume migration and degradation predicted by models PATC and PATD, the Air Force is recommending continued bioventing coupled with natural attenuation, institutional controls, and LTM as the remedial option for BTEX-impacted groundwater near Site ST-29. Construction activities and groundwater use in and downgradient from the source area should be restricted for a period of approximately 12 years.

To verify the results of the Bioplume II modeling effort, and to ensure that natural attenuation is occurring at rates sufficient to protect potential downgradient receptors, groundwater from existing monitoring well PB-5/MW-11, from existing monitoring points CPT-03, CPT-14, and CPT-18, and from two proposed LTM wells should be sampled semiannually and analyzed for the parameters listed in Tables 7.1 and 7.2. In addition, three POC groundwater monitoring wells should be installed downgradient from the predicted maximum travel distance of the BTEX plume. Figure 7.1 shows suggested locations for the

three new POC monitoring wells and the two new LTM wells. These wells should be sampled semiannually for 12 years, and the samples should be analyzed for the parameters listed in Tables 7.1 and 7.2. If dissolved BTEX concentrations in groundwater in the POC wells are found to exceed the Florida regulatory standards of 1 µg/L for benzene, 50 µg/L for total BTEX, 3 µg/L for 1,2-dichloroethane, 0.02 µg/L for 1,2-dibromoethane, 50 µg/L for lead, and 50 µg/L for methyl tert-butyl ether, additional evaluation or corrective action may be necessary at this site. A site-specific RAP, SAP, and quality assurance project plan (QAPP), should be submitted to the Florida Department of Environmental Protection for approval prior to implementation of the recommended remedial alternative for Site ST-29.

SECTION 9

REFERENCES

- Abdul, S.A., Gibson, T.L., and Rai, D.N., 1987, Statistical Correlations for Predicting the Partition Coefficient for Nonpolar Organic Contaminants Between Aquifer Organic Carbon and Water: *Hazardous Waste and Hazardous Materials*, 4(3):211-222.
- Anderson, M.P., and Woessner, W.W., 1992, *Applied Groundwater Modeling - Simulation of Flow and Advective Transport*: Academic Press, New York, 381 p.
- Barr, K.D., 1992, Enhanced groundwater remediation bioventing and its simulation by biomodeling, *in* Proceedings of the Air Force Environmental Restoration Technology Symposium: San Antonio, Texas.
- Bear, J., 1979, *Hydraulics of Groundwater*: McGraw-Hill, Inc., New York, New York, 569.
- Beller, H.R. Reinhard, M., and Grbic'-Galic', D., 1992, Metabolic byproducts of anaerobic toluene degradation by sulfate-reducing enrichment cultures: *Appl. Environ. Microbiol.*, v. 58, p. 3192-3195.
- Bohon, R.L., and Claussen, W.F., 1951, The Solubility of Aromatic Hydrocarbons in Water: *Journal of American Chemical Society*, 73(4):1571-1578.
- Borden, R.C., and Bedient, P.B., 1986, Transport of Dissolved Hydrocarbons Influenced by Oxygen Limited Biodegradation - Theoretical Development: *Water Resources Research*, 22 (13) 1973-1982.
- Bouwer, E.J., 1992, Bioremediation of Subsurface Contaminants, *in* Mitchell, R., ed.: *Environmental Microbiology*: Wiley-Liss, New York, New York.
- Bouwer, H., 1989, The Bouwer and Rice Slug Test - an Update: *Groundwater*, 27(3), p. 304-309.
- Bouwer, H., and Rice, R.C., 1976, A Slug Test for Determining Hydraulic Conductivity of Unconfined Aquifers with Completely or Partially Penetrating Wells: *Water Resources Research*, 12(3), P. 423-428.
- Bredehoeft, J.D., 1967, Response of well-aquifer systems to earth tides: *Journal of Geophysical Research*, v. 72, p. 3075 - 3087.
- CH2M Hill, 1994, Field data shared by CH2M Hill personnel (March).

- Cozzarelli, I.M., Eganhouse, R.P., and Baedecker, M.J., 1990, Transformation of Monoaromatic Hydrocarbons to Organic Acids in Anoxic Groundwater Environment: Environmental and Geological Water Science, 16.
- Davies, J.S., and Westlake, D.W.S., 1979, Crude Oil Utilization by Fungi: Canadian Journal of Microbiology, 25:146-156.
- Department of the Air Force, 1983, Comprehensive Plan, Base Layout, Patrick Air Force Base, Cocoa Beach, Florida.
- Domenico, P.A., and Schwartz, F.W., 1990, Physical and Chemical Hydrogeology: John Wiley and Sons, New York, New York, 824 p.
- Edwards, E.A., and Grbic'-Galic', D., 1992, Complete mineralization of benzene by aquifer microorganisms under strictly anaerobic conditions: Appl. Environ. Microbiol., v. 58, p. 2663-2666.
- Edwards, E.A., Wells, L.E., Reinhard, M., and Grbic'-Galic', D., 1992, Anaerobic degradation of toluene and xylene by aquifer microorganisms under sulfate-reducing conditions: Appl. Environ. Microbiol., v. 58, p. 794-800.
- Engineering-Science, Inc., 1993, Bioventing Test Work Plan and Interim Results Report for Three Bioventing Sites at Patrick Air Force Base and Cape Canaveral Air Force Station, Florida. Prepared for the Air Force Center for Environmental Excellence and Patrick Air Force Base, Florida.
- Engineering-Science, Inc., 1994a, A Performance and Cost Evaluation of Internal Combustion Engines for the Destruction of Hydrocarbon Vapors from Fuel-Contaminated Soils. Prepared for the Air Force Center for Environmental Excellence. August 1994.
- Engineering-Science, Inc., 1994b, Bioventing Performance and Cost Summary. Prepared for the Air Force Center for Environmental Excellence. July 1994.
- Environmental Science and Engineering, Inc., 1984, Installation Restoration Program, Phase I: Records Search, Eastern Space & Missile Center: Patrick Air Force Base, Florida. Vols. I and II.
- Environmental Science and Engineering, Inc., 1988, Installation Restoration Program, Phase II: Confirmation/Quantification, Stage I, Patrick Air Force Base, Florida. Vol. I - X.
- Environmental Science and Engineering, Inc., 1991, Installation Restoration Program, Phase II, Stage 2: Remedial Investigation/Feasibility Study, Patrick Air Force Base, Florida. Vol. I - X.
- Freeze, R.A., and Cherry, J.A., 1979, Groundwater: Prentice-Hall, Inc., Englewood Cliffs, New Jersey.
- Gildea, M.L., Bratton, W.L., Shinn, J.D., St. Germain, R., and Gillespie, G.D., 1994, Demonstration of the Air Force Site Characterization and Analysis Penetrometer System (AFSCAPS) at Patrick AFB in Support of the Intrinsic Remediation (Natural

- Attenuation) Option: Applied Research Associates, Inc., South Royalton Vermont, ARA report number 5868-322, May 1994.
- Goldstein, R.M., Mallory, L.M., and Alexander, M., 1985, Reasons for Possible Failure of Inoculation to Enhance Biodegradation: *Applied Environmental Microbiology*, 50(4):977-983.
- Grbic'-Galic', D., 1990, Anaerobic microbial transformation of nonoxygenated aromatic and alicyclic compounds in soil, subsurface, and freshwater sediments, *in* Bollag, J.M., and Stotzky, G., eds.: *Soil Biochemistry*: Marcel Dekker, Inc., New York, p. 117-189.
- Grbic'-Galic', D., and Vogel, T.M., 1987, Transformation of toluene and benzene by mixed methanogenic cultures: *Applied and Environmental Microbiology*, v. 53, p. 254-260.
- Hine, J., and Mookerjee, P.K., 1975, The Intrinsic Hydrophilic Character of Organic Compounds. Correlations in Terms of Structural Contributions: *Journal of Organic Chemistry*, 40(3):292-298.
- Hopper, D.J., 1978, Microbial Degradation of Aromatic Hydrocarbons In R.J. Watkinson (editor), *Developments in Biodegradation of Hydrocarbons, I*: Applied Science Publishers, Ltd., London.
- Hutchins, S.R., 1991, Biodegradation of monoaromatic hydrocarbons by aquifer microorganisms using oxygen, nitrate, or nitrous oxide as the terminal electron acceptor: *Appl. Environ. Microbiol.*, v. 57, p. 2403-2407.
- Isnard, S., and Lambert, S., 1988, Estimating Bioconcentration Factors from Octanol-Water Partition Coefficient and Aqueous Solubility: *Chemosphere*, 17(1):21-34.
- Jamison, V.W., Raymond, R.L., and Hudson, J.O. Jr., 1975, Biodegradation of high-octane gasoline in groundwater: *Developments in Industrial Microbiology*, v. 16.
- Jones, J.G., and Eddington, M.A., 1968, An Ecological Survey of Hydrocarbon-Oxidizing Microorganisms: *Journal of General Microbiology*, 52:381-390.
- Jury, W.A., Spencer, W.F., and Farmer, W.J., 1984, Behavior Assessment Model for Trace Organics in Soil: III, Application of Screening Model: *Journal of Environmental Quality*, 13(4):573-579.
- Konikow, L.F., 1978, Calibration of ground-water models, *in* *Verification of Mathematical and Physical Models in Hydraulic Engineering*: American Society of Civil Engineers, New York, pp. 87 - 93.
- Konikow, L.F., and Bredehoeft, J.D., 1978, Computer model of two-dimensional solute transport and dispersion in groundwater: United States Geological Survey, *Techniques of Water Resources Investigations of the United States Geological Survey, Book 7, Chapter C2*, 90 p.
- Lovely, D.R., Baedecker, M.J., Lonergan, D.J., Cozzarelli, I.M., Phillips, E.J.P., and Siegel, D.I., 1989, Oxidation of aromatic contaminants coupled to microbial iron reduction: *Nature*, v. 339, p. 297-299.

- Lyman, W.J., Reidy, P.J., and Levy, B., 1992, Mobility and Degradation of Organic Contaminants in Subsurface Environments: C.K. Smoley, Inc., Chelsea, Michigan.
- Mackay, D., and Wolkoff, A.W., 1973, Rate of Evaporation of Low-Solubility Contaminants from Water Bodies to Atmosphere: *Environmental Science and Technology*, 7(7):611-614.
- Mackay, D., and Shiu, W.Y., 1981, A Critical Review of Henry's Law Constants for Chemicals of Environmental Interest: *Journal of Physical Chemistry Reference Data*, 10(4):1175-1199.
- Micromedex, Inc., 1995, Toxicological, Occupational Medicine, and Environmental Series (TOMES) Plus Database, Vol. 24, Denver, Colorado.
- Miller, M.M., Wasik, S.P., Huang, G.L., Shiu, W.Y., and Mackay, D., 1985, Relationships Between Octanol-Water Partition Coefficient and Aqueous Solubility: *Environmental Science and Technology*, 19(6):522-529.
- National Research Council, 1993, *In Situ Bioremediation, When Does it Work?:* National Academy Press, Washington, D.C., 207 p.
- O'Brien and Gere Engineers, Inc., 1992, ST-29 (PPOL-2) Work Plan Draft Final Report, Patrick Air Force Base, Florida.
- Pankow, J.F., and Rosen, M.E., 1988, Determination of Volatile Compounds in Water by Purging Directly to a Capillary Column with Whole Column Cryotrapping: *Environmental Science and Technology*, 22(4):398-405.
- Perry, J.J., 1984, Microbial Metabolism of Cyclic Alkanes, *in* Atlas, R.M. ed.: *Petroleum Microbiology*: Macmillan Publishing Co., New York, New York.
- Ribbons, D.W., and Eaton, R.W., 1992, Chemical Transformations of Aromatic Hydrocarbons that Support the Growth of Microorganisms: *in* Mitchell, R., ed.: *Environmental Microbiology*: Wiley-Liss, New York, New York.
- Rifai, H.S., Bedient, P.B., Wilson, J.T., Miller, K.M., and Armstrong, J.M., 1988, Biodegradation modeling at aviation fuel spill site: *Journal of Environmental Engineering*, v. 114, no. 5, p. 1007-1029.
- US Environmental Protection Agency, 1991, Role of the Baseline Risk Assessment in Superfund Remedy Selection Decisions: Memorandum from Don R. Clay, Assistant Administrator of the Office of Solid Waste and Emergency Response, OSWER Directive 9355.0-30.
- US Geological Survey, 1949a, 7.5 Minute Quadrangle Orthophoto Map of the Eau Galle Quadrangle, Brevard County, Florida.
- US Geological Survey, 1949b, 7.5 Minute Quadrangle Orthophoto Map of the Tropic Quadrangle, Brevard County, Florida.
- US Geological Survey, 1976a, 7.5 Minute Quadrangle Orthophoto Map of the Cocoa Quadrangle, Brevard County, Florida.

- US Geological Survey, 1976b, 7.5 Minute Quadrangle Orthophoto Map of the Cocoa Beach Quadrangle, Brevard County, Florida.
- Valsaraj, K.T., 1988, On the Physio-Chemical Aspects of Partitioning of Non-Polar Hydrophobic Organics at the Air-Water Interface: *Chemosphere*, 17(5):875-887.
- Verschueren, K., 1983, *Handbook of Environmental Data on Organic Chemicals*: Van Nostrand Reinhold Co., New York, New York.
- Vroblesky, D.A., and Chapelle, F.H., 1994, Temporal and spatial changes of terminal electron-accepting processes in a petroleum hydrocarbon-contaminated aquifer and the significance for contaminant biodegradation: *Water Resources Research*, v. 30, no. 5, p. 1561-1570.
- Walton, W.C., 1988, *Practical Aspects of Groundwater Modeling*: National Water Well Association, Dublin, Ohio, 587 p.
- Wilson, B.H., Smith, G.B., and Rees, J.F., 1986, Biotransformations of Selected Alkylbenzenes and Halogenated Aliphatic Hydrocarbons in Methanogenic Aquifer Material: A Microcosm Study: *Environmental Science and Technology*, 20(10):997-1002.
- Wilson, B.H., Wilson, J.T., Kampbell, D.H., Bledsoe, B.E., and Armstrong, J.M., 1990, Biotransformation of Monoaromatic and Chlorinated Hydrocarbons at an Aviation Gasoline Spill Site: *Geomicrobiology Journal*, 8:225-240.
- Wiedemeier, T.H., Wilson, J.T., Kampbell, D.H., Miller, R.N., and Hansen, J.E., 1995, Draft Technical Protocol for Implementing Intrinsic Remediation with Long-Term Monitoring for Natural Attenuation of Fuel Contamination Dissolved in Groundwater: Air Force Center for Environmental Excellence, Brooks Air Force Base, Texas.